











Trelleborg  
Agriculture

Technical manual



# Technical Manual Index

Application	Technology	Tread pattern	Page
<b>TRACTORS</b> 	Radial	TM1000 ProgressiveTraction®	16
		TM1000 High Power	26
		TM900 High Power	29
		TM1060	35
		TM800 ProgressiveTraction®	39
		TM800	39
		TM800 High Speed	50
		TM700 ProgressiveTraction®	54
		TM700	59
		TM700 Vineyard and Orchard	69
		TM700 High Speed	71
		PneuTrac®	72
		TM600	74
		TM600 Rice	74
		TM150	90
		TM100	93
	TM190	98	
	Marshland	100	
	TM300S	102	
	X-Ply	TM90	103
		TD27	116
TD300		119	
Twin Tractor: T414		122	
IM110		126	
<b>HARVESTERS</b> 	Radial	TM900 High Power	29
		TM800 Forage	39
		TM800 Sugar Cane	39
		TM800 High Speed	50
		TM3000	140
		TM2000	143
<b>TRANSPORT EQUIPMENT</b> 	Radial	HF1000	146
		Twin Radial	147
	X-Ply	Twin Implement: T404 - T421 - T423 - 478	153
		Twin Ampt: T421 - T423 - T428 - T440	172
		Implement Standard: AW305 - AF302 - T452 - T306	176
		AW309 Flotation	176

Application	Technology	Tread pattern	Page		
<b>SPRAYERS &amp; SPREADERS</b> 	Radial	TM1000 ProgressiveTraction®	16		
		TM1000 High Power	26		
		TM600	74		
		TM150	90		
		TM100	93		
		TM3000	140		
<b>CROP PROCESSING AND GREEN AREA EQUIPMENT</b> 	X-Ply	TM90 Irrigation	103		
		IM110	126		
		IM220	126		
		T452	176		
		Twin Garden Tractor: T404	190		
		Light service tires (DRIVER - GARDENER - T49 - T63 T94 - T411 - T412 - T413 - T415 - T421 - T310 - T430 T446 - T448 - T462 - T463 - T501 - T510 T513 - T521 T522 - T523 - T528 - T530 - T533 - T536 - T537 T539 - T550 - T559 Turf Grip - T560 ICE - T570 - T690 T991 - HIGH GRIP TRACTION)	192		
		<b>AGRO INDUSTRIAL TIRES</b> 	Radial	TH400	224
				TH500	224
				MPT100	232
		<b>AGRO INDUSTRIAL TIRES</b> 	X-Ply	TB40	234
Industrial Tractors: T440 EXC - T480 EXC - T459	236				
<b>FORESTRY TIRES</b> 	X-Ply	Agro Forest: T410	240		
		Twin Forestry: T404 - T414 - T421 SB - T428 SB T440 SB - T480 SB	244		
		T418 Forestry Skidder	256		

# Radial tires by segment







TREAD PATTERN	TRACTORS	HARVESTERS	TRANSPORT EQUIPMENT	SPRAYERS & SPREADERS	CROP PROCESSING AND GREEN AREA EQUIPMENT	AGRO INDUSTRIAL EQUIPMENT	FORESTRY EQUIPMENT	PAGE
TM1000 ProgressiveTraction®	√			√				16
TM1000 High Power	√			√				26
TM900 High Power	√	√						29
TM1060	√							35
TM800 ProgressiveTraction®	√							39
TM800	√							39
TM800 Forage		√						39
TM800 Sugar Cane		√						39
TM800 High Speed	√	√						50
TM700 ProgressiveTraction®	√							54
TM700	√							59
TM700 Vineyard and Orchard	√							69
TM700 High Speed	√							71
PneuTrac®	√							72
TM600	√			√				74
TM600 Rice	√							74
TM190	√							98
Marshland	√							100
TM300S	√							102
TM3000		√		√				140
TM2000		√						143
HF1000			√					146
Twin Radial			√					147
TM100	√			√				93
TM150	√			√				90
TH400						√		224
TH500						√		224
MPT100						√		232

# X-ply tires by segment



TREAD PATTERN	TRACTORS	HARVESTERS	TRANSPORT EQUIPMENT	SPRAYERS & SPREADERS	CROP PROCESSING AND GREEN AREA EQUIPMENT	AGRO INDUSTRIAL EQUIPMENT	FORESTRY EQUIPMENT	PAGE
TM90	√							103
TD27	√							116
TD300	√							119
IM110	√				√			126
Twin Tractor T414	√							122
IM220					√			126
T452					√			176
TM90 Irrigation					√			103
Twin Implement: T404 - T421 - T423 - 478			√					153
Twin Ampt: T421 - T423 - T428 - T440			√					172
Twin Garden Tractor: T404					√			190
Implement Standard: AW305 - AF302 - T306 AW309 Flotation			√					176
Agro Forest: T410							√	240
Twin Forestry: T404 - T414 - T421 SB T428 SB - T440 SB T480 SB							√	244
T418 Forestry Skidder							√	256
TB40						√		234
Industrial Tractors: T440 EXC - T480 EXC T459						√		236
Light service tires (DRIVER - GARDENER - T49 T63 - T94 - T411 - T412 T310 - T413 - T415 - T421 T430 - T446 - T448 - T462 T463 - T501 - T510 - T513 T521 - T522 - T523 - T528 T530 - T533 - T536 - T537 T539 - T550 - T559 Turf Grip T560 ICE - T570 - T690 T991 - HIGH GRIP - TRACTION)					√			192

# Radial tires

Size	Tread pattern	Application	Page
<b>16"</b>			
11LR16 IND	TH400	Agro industrial equipment	224
210/95R16	TM600	Tractors, sprayers and spreaders	75
240/70R16	TM700 	Tractors	69
260/70R16	TM700 		69
280/70R16	TM700 		70
<b>18"</b>			
210/95R18	TM600	Tractors, sprayers and spreaders	75
280/70R18	TM700 	Tractors	70
VF 280/70R18	PneuTrac®		72
320/65R18	TM800		40
340/65R18	TM800		40
340/80R18 IND	TH500	Agro industrial equipment	228
340/80R18 IND	TH400		224
400/70R18 IND	TH400		226
<b>20"</b>			
280/70R20	TM700 	Tractors	70
VF 280/70R20	PneuTrac®		72
280/85R20	TM600	Tractors, sprayers and spreaders	75
300/70R20	TM700	Tractors	59
320/70R20	TM700		60
320/85R20	TM600	Tractors, sprayers and spreaders	76
360/70R20	TM700	Tractors	60
380/70R20	TM700		60
7.50R20	TM190		98
9.5R20	TM190		98
400/70R20 IND	TH500	Agro industrial equipment	228
400/70R20 IND	TH400		226
405/70R20 MPT	MPT1100		232
425/75R20 MPT	MPT1100		232
<b>22.5"</b>			
445/65R22.5 MPT	MPT1100	Agro industrial equipment	232
500/60R22.5	TWIN RADIAL	Transport	148
560/60R22.5	TWIN RADIAL		148
580/65R22.5	TWIN RADIAL		149
600/50R22.5	TWIN RADIAL		149
<b>24"</b>			
400/70R24 IND	TH400	Agro industrial equipment	226
440/80R24 IND	TH400		226
460/70R24 IND	TH400		226
460/70R24 IND	TH500		230
500/70R24 IND	TH400		228
500/70R24 IND	TH500		230
250/85R24	TM600	Tractors, sprayers and spreaders	76
280/85R24	TM600	Tractors	76
320/70R24	TM700		61
320/85R24	TM600	Tractors, sprayers and spreaders	77
340/85R24	TM600	Tractors	77
360/70R24	TM700		61
380/70R24	TM700		61
380/85R24	TM600	Tractors, sprayers and spreaders	77
420/70R24	TM700	Tractors	62
420/85R24	TM600	Tractors, sprayers and spreaders	78
440/65R24	TM800	Tractors	40
480/65R24	TM800		41
480/70R24	TM700		62
540/65R24 **	TM800		41
540/65R24	TM800		41
8.3R24	TM190		99
9.5R24	TM190		99

Size	Tread pattern	Application	Page	
<b>25"</b>				
VF 1000/50R25	TM3000	Harvesters, sprayers and spreaders	140	
<b>26"</b>				
480/70R26	TM700	Tractors	62	
540/65R26	TM800		42	
VF 620/70R26 CFO	TM3000	Harvesters, sprayers and spreaders	140	
620/75R26	TM2000	Harvesters	141	
VF 750/50R26	TM3000	Harvesters, sprayers and spreaders	143	
VF 750/65R26 CFO	TM3000		141	
480/80R26 IND	TH400	Agro industrial equipment	228	
<b>26.5"</b>				
600/55R26.5	TWIN RADIAL	Transport equipment	150	
680/55R26.5	TWIN RADIAL		150	
710/50R26.5	TWIN RADIAL		150	
<b>28"</b>				
440/80R28 IND	TH400	Agro industrial equipment	228	
540/65R28	TM800 PT	Tractors	43	
280/85R28	TM600	Tractors, sprayers and spreaders	78	
320/70R28	TM700	Tractors	63	
320/85R28	TM600	Tractors, sprayers and spreaders	78	
340/85R28	TM600****		79	
360/70R28	TM700	Tractors	63	
380/70R28	TM700		63	
380/70R28	TM700 PT		54	
380/85R28	TM600	Tractors, sprayers and spreaders	79	
420/70R28	TM700	Tractors	64	
420/70R28	TM700 PT		55	
VF 420/70R28	PneuTrac®		73	
420/85R28	TM600****	Tractors, sprayers and spreaders	79	
440/65R28	TM800	Tractors	42	
VF 480/60R28	TM1060		35	
480/65R28	TM800		42	
VF 480/65R28	PneuTrac®		73	
480/70R28	TM700		64	
480/70R28	TM700 PT		55	
VF 520/60R28	TM1060	36		
540/65R28***	TM800	43		
540/65R28	TM800 HS	Tractors and harvesters	50	
VF 600/60R28	TM1060	Tractors	36	
600/65R28	TM800		43	
600/65R28	TM800 HS	Tractors and harvesters	51	
600/70R28	TM900 HP		29	
<b>30"</b>				
380/85R30	TM600*	Tractors, sprayers and spreaders	80	
420/70R30	TM700	Tractors	65	
420/85R30	TM600****		80	
420/90R30	TM600	Tractors, sprayers and spreaders	80	
460/85R30	TM600	Tractors	81	
480/70R30	TM700		65	
480/70R30	TM700 HS		71	
480/70R30	TM700 PT		55	
520/70R30	TM700		65	
520/70R30	TM700 HS		71	
540/65R30	TM800		44	
540/65R30	TM800 HS		Tractors and harvesters	51

Size	Tread pattern	Application	Page
<b>30"</b>			
VF 540/65R30	TM1000 PT	Tractors, sprayers and spreaders	17
VF 600/60R30	TM1060	Tractors	26
IF 600/70R30	TM1000 HP	Tractors, sprayers and spreaders	36
600/70R30	TM900 HP	Tractors and harvesters	30
VF 600/70R30	TM1000 PT	Tractors, sprayers and spreaders	17
VF 620/75R30	TM1000 PT		17
710/60R30	TM900 HP		Tractors and harvesters
<b>30.5"</b>			
650/65R30.5	TWIN RADIAL	Transport equipment	151
VF750/60R30.5 IMP HF1000			146
750/60R30.5	TWIN RADIAL		151
850/50R30.5	TWIN RADIAL		151
<b>32"</b>			
VF800/60R32 IMPHF1000		Transport equipment	146
800/60R32	TWIN RADIAL		152
VF 1050/50R32	TM3000	Harvesters, sprayers and spreaders	142
650/75R32	TM3000		141
650/75R32	TM2000	Harvesters	144
710/75R32	TM2000		144
800/65R32	TM2000		144
IF 800/65R32 CFO	TM3000		141
IF 800/70R32 CFO	TM3000	Harvesters, sprayers and spreaders	142
900/60R32	TM2000	Harvesters	145
IF 900/65R32 CFO	TM3000	Harvesters, sprayers and spreaders	142
230/95R32	TM100	Tractors, sprayers and spreaders	93
270/95R32	TM100		93
<b>34"</b>			
380/85R34	TM600	Tractors, sprayers and spreaders	81
420/85R34	TM600		82
VF 420/85R34	TM1000 PT		18
460/85R34	TM600		82
480/70R34	TM700	Tractors	66
480/70R34	TM700 PT		56
520/70R34	TM700		66
540/65R34	TM800		44
540/65R34	TM800 HS	Tractors and harvesters	51
600/65R34	TM800	Tractors	44
600/65R34	TM800 HS	Tractors and harvesters	52
600/70R34	TM900 HP		30
VF 650/60R34	TM1000 PT	Tractors, sprayers and spreaders	18
650/60R34	TM900 HP	Tractors and harvesters	31
IF 650/65R34	TM1000 HP	Tractors, sprayers and spreaders	27
VF 650/65R34	TM1000 PT		19
710/55R34	TM900 HP	Tractors and harvesters	31
710/60R34	TM900 HP		31
VF 710/60R34	TM1000 PT		Tractors, sprayers and spreaders
<b>36"</b>			
230/95R36	TM100	Tractors, sprayers and spreaders	94
12.4R36	TM190	Tractors	99
13.6R36	TM300S		102

Size	Tread pattern	Application	Page
<b>38"</b>			
650/65R38	TM800 PT	Tractors	46
270/95R38	TM100	Tractors, sprayers and spreaders	94
320/85R38	TM600		83
340/85R38	TM600		83
380/80R38	TM600		83
380/85R38	TM600		84
380/95R38	TM600*		84
400/75R38	TM600		84
420/85R38	TM600		85
420/85R38	TM600*		85
460/85R38	TM600****		85
480/70R38	TM700	Tractors	67
480/70R38	TM700 PT		56
480/80R38	TM600*	Tractors, sprayers and spreaders	86
520/70R38	TM700	Tractors	67
520/70R38	TM700 PT		57
520/85R38	TM600 HD	Tractors, sprayers and spreaders	86
520/85R38	TM600*		86
540/65R38	TM800	Tractors	45
540/65R38	TM800 HS	Tractors and harvesters	52
580/70R38	TM700	Tractors	67
580/70R38	TM700 PT		57
VF 600/60R38	TM1060		37
600/65R38	TM800		45
VF 650/60R38	TM1060		37
650/65R38	TM800		45
650/65R38	TM800 HS	Tractors and harvesters	52
IF 650/65R38	TM1000 HP	Tractors, sprayers and spreaders	27
VF 650/65R38	TM1000 PT		19
650/75R38	TM900 HP	Tractors and harvesters	32
650/85R38	TM900 HP		32
VF 650/85R38	TM1000 PT	Tractors, sprayers and spreaders	19
VF 710/60R38	TM1060	Tractors	38
VF 710/60R38	TM1000 PT		20
710/70R38	TM800		46
710/70R38	TM800		47
Sugar Cane	TM800	Harvesters	48
710/70R38	Forage		48
710/70R38	TM800 HS	Tractors and harvesters	53
800/70R38	TM900 HP		32
IF 800/70R38 CFO	TM3000	Harvesters, sprayers and spreaders	142
VF 800/70R38	TM1000 PT	Tractors, sprayers and spreaders	20
900/60R38	TM900 HP	Tractors and harvesters	33
380/85R38	MARSHLAND	Tractors	100
420/85R38	MARSHLAND		100
460/85R38	MARSHLAND		101

\* In ProgressiveTraction® version  
\*\* For harvesting applications  
\*\*\* Also in ProgressiveTraction® version  
\*\*\*\* Also in HD version

# Radial tires

Size	Tread pattern	Application	Page
<b>42"</b>			
480/80R42	TM600****	Tractors, sprayers and spreaders	87
520/85R42	TM600****		87
580/70R42	TM700		68
580/70R42	TM700 PT		57
600/65R42	TM800	Tractors	48
620/70R42	TM700		68
620/70R42	TM700 PT		58
650/65R42	TM800		49
VF 650/65R42	TM1000 PT		20
VF 650/75R42	TM1000 PT	Tractors, sprayers and spreaders	21
VF 650/85R42	TM1000 PT		21
VF 710/60R42	TM1060	Tractors	38
710/70R42	TM900 HP	Tractors and harvesters	33
710/70R42 **	TM900 HP		34
710/70R42	TM900 HP		33
Harvester			
IF 710/70R42	TM1000 HP	Tractors, sprayers and spreaders	27
VF 710/70R42	TM1000 PT		21
710/75R42	TM900 HP	Tractors and harvesters	34
VF 710/75R42	TM1000 PT	Tractors, sprayers and spreaders	22
900/60R42	TM900 HP	Tractors and harvesters	34
IF 900/60R42	TM1000 HP		28
VF 900/60R42	TM1000 PT	Tractors, sprayers and spreaders	22
<b>44"</b>			
210/95R44	TM100		94
230/95R44	TM100	Tractors, sprayers and spreaders	95
270/95R44	TM100		95
VF 750/70R44	TM1060	Tractors	38

Size	Tread pattern	Application	Page
<b>46"</b>			
VF 300/95R46	TM100		95
VF 380/85R46	TM1000 PT		23
VF 380/90R46	TM150		90
VF 380/105R46	TM150		91
480/80R46	TM600	Tractors, sprayers and spreaders	88
VF 480/80R46	TM150		91
520/85R46	TM600		88
VF 520/85R46	TM150		91
VF 750/75R46	TM1000 PT		23
VF 900/65R46	TM1000 PT		24
<b>48"</b>			
230/95R48	TM100	Tractors, sprayers and spreaders	96
270/95R48	TM100		96
<b>50"</b>			
380/90R50	TM100		96
VF 380/105R50	TM150		92
480/80R50	TM600		88
480/80R50 Rice	TM600	Tractors, sprayers and spreaders	88
VF 480/80R50	TM1000 PT		24
VF 480/80R50	TM150		92
VF 520/85R50	TM150		92
480/95R50	TM600*		89
<b>52"</b>			
300/95R52	TM100	Tractors, sprayers and spreaders	97
<b>54"</b>			
380/90R54	TM100		97
VF 480/95R54	TM1000 PT	Tractors, sprayers and spreaders	25
VF 380/105R54	TM150		90

\* In ProgressiveTraction® version  
 \*\* For harvesting applications  
 \*\*\* Also in ProgressiveTraction® version  
 \*\*\*\* Also in HD version



# Cross-Ply tires

Size	Tread pattern	Application	Page	
<b>10"</b>				
5.00-10	IM110	Tractors, crop processing and green area equipment	126	
<b>12"</b>				
6.5/80-12	IM110	Tractors, crop processing and green area equipment	128	
10.0/80-12	IM110		128	
4.00-12	IM110		126	
5.00-12	IM110		128	
7.00-12	IM110		128	
200/95-12	AF302	Transport equipment	176	
10.0/80-12	AW305		188	
<b>13"</b>				
260/90-13	AF302	Transport equipment	178	
<b>14"</b>				
5.00-14	IM110	Crop processing and green area equipment	130	
<b>15"</b>				
4.00-15	TD27	Tractors	116	
5.00-15	TD27		116	
9.5L-15	TD300		119	
7.5L-15	IM110	Tractors, crop processing and green area equipment	130	
6.5/80-15	IM110		130	
5.00-15	IM110		130	
<b>15.5"</b>				
280/60-15.5	T421	Transport equipment	154	
280/60-15.5	T478		154	
400/45-15.5	T423		154	
400/60-15.5	T404		156	
400/60-15.5	T478		156	
<b>16"</b>				
5.50-16	TD27	Tractors	117	
6.00-16	TD27		117	
6.50-16	TD27		117	
7.50-16	TD27		118	
7.50-16	TD300		120	
8-16	TM90		104	
9.00-16	TD300		120	
10.00-16	TD300		120	
9.0/75-16	IM110		134	
250/80-16	IM110		134	
6.00-16	IM110		Tractors, crop processing and green area equipment	132
6.50-16	IM110			132
7.50-16	IM110			134
8.25-16	IM110	134		

Size	Tread pattern	Application	Page
<b>16"</b>			
180/90-16	AF302	Transport equipment	182
190/90-16	AF302		182
200/90-16	AF302		182
210/95-16	AF302		182
260/70-16	AW305		184
340/55-16	AW305		184
340/55-16	AW309		184
360/65-16	AW305	184	
360/70-16	AW305	184	
<b>17"</b>			
420/55-17	T421	Transport equipment	156
380/55-17	AW305		186
420/55-17	T452	Crop processing and green area equipment	186
480/45-17	AW305		186
480/45-17	AW309	Transport equipment	186
500/50-17	AW309		188
520/50-17	T306		188
<b>17.5"</b>			
400/55-17.5	T404	Transport equipment	158
400/55-17.5	T404	Crop processing and green area equipment	158
400/55-17.5	T414	Forestry equipment	122
<b>18"</b>			
250/80-18	IM110	Tractors, crop processing and green area equipment	136
7.50-18	IM110		136
7.50-18	TD300	Tractors	121
8-18	TM90		104
320/80-18	TB40	Agro industrial equipment	235
340/80-18	TB40		235
<b>19"</b>			
4.50-19	IM110	Tractors, crop processing and green area equipment	136
<b>20"</b>			
500/55-20	AW309	Transport equipment	188
210/95-20	IM220	Crop processing and green area equipment	138
8.3-20	TM90	Tractors	104
11.2-20	TM90		105

# Cross-Ply tires

Size	Tread pattern	Application	Page	
<b>21"</b>				
4.00/4.50-21	TD27	Tractors	118	
4.00-21	IM110	Tractors, crop processing and green area equipment	136	
<b>22.5"</b>				
400/55-22.5	T404	Transport equipment	158	
500/45-22.5	T404		158	
500/60-22.5	T404		158	
500/60-22.5	T421		160	
560/45-22.5	T404		160	
560/60-22.5	T404		160	
600/50-22.5	T404		162	
600/50-22.5	T423		162	
710/40-22.5	T404		164	
620/50B-22.5	T423		172	
650/45B-22.5	T440		172	
710/40B-22.5	T423		172	
400/55-22.5	T404		Crop processing and green area equipment	190
400/55-22.5	T404		Transport equipment	158
500/60-22.5	T421 SB	Forestry equipment	254	
600/50-22.5 LS2	T480 SB		246	
650/45-22.5 LS2	T440 SB		246	
710/40-22.5 LS2	T480 SB		246	
600/50-22.5	T480 EXC	Agro industrial equipment	236	
650/45-22.5	T440 EXC		236	
710/40-22.5 LS2	T480 EXC		238	
<b>24"</b>				
8.3-24	TM90	Tractors	105	
9.5-24	TM90		105	
11.2-24	TM90		106	
12.4-24	TM90		106	
13.6-24	TM90		107	
14.9-24	TM90		107	
16.9-24	TM90		107	
320/85-24	T410		Forestry equipment	240
380/85-24	T410	240		

Size	Tread pattern	Application	Page	
<b>24.5"</b>				
710/40-24.5 LS2	T440 SB	Forestry equipment	246	
710/40-24.5 LS2	T480 SB		246	
<b>26"</b>				
14.9-26	TM90	Tractors	108	
16.9-26	TM90		108	
23.1-26	T418	Forestry equipment	256	
28L-26	T418		256	
<b>26.5"</b>				
600/55-26.5	T414	Forestry equipment	122	
400/60-26.5	T404	Transport equipment	164	
600/55-26.5	T404		164	
600/55-26.5	T421		164	
710/45-26.5	T404		166	
710/45-26.5	T423		166	
800/40-26.5	T404		166	
800/40-26.5	T423		168	
620/55B-26.5	T421		174	
600/55-26.5 LS2	T440 SB		Forestry equipment	248
600/55-26.5 LS2	T480 SB			248
710/45-26.5 LS2	T440 SB	248		
710/45-26.5 LS2	T480 SB	248		
750/55-26.5 LS2	T440 SB	250		
750/55-26.5 LS2	T480 SB	250		
800/40-26.5 LS2	T440 SB	250		
800/40-26.5 LS2	T480 SB	250		
<b>28"</b>				
12.4-28	TM90	Tractors	109	
13.6-28	TM90		109	
14.9-28	TM90		110	
16.9-28	TM90		110	
380/85-28	T410	Forestry equipment	240	
420/85-28	T410		240	
440/80-28	TB40	Agro industrial equipment	234	
<b>28.5"</b>				
780/50-28.5 LS2	T480 SB	Forestry equipment	250	

Size	Tread pattern	Application	Page
<b>30"</b>			
14.9-30	TM90	Tractors	111
16.9-30	TM90		111
18.4-30	TM90		111
460/85-30	T410	Forestry equipment	242
<b>30.5"</b>			
600/55-30.5	T414	Tractors	122
600/60-30.5	T404	Crop processing and green area equipment	190
600/60-30.5	T414	Tractors	122
800/55-30.5	T414		124
650/65-30.5	T404	Transport equipment	168
710/50-30.5	T404		168
710/50-30.5	T423		170
750/60-30.5	T404		170
800/45-30.5	T404		170
800/45-30.5	T423		170
850/50-30.5	T404		174
650/55B-30.5	T428		174
750/50B-30.5	T428		174
850/45B-30.5	T423		190
600/60-30.5	T404	Forestry equipment	254
600/60-30.5	T414		252
750/45-30.5 LS2	T428 SB		252
<b>32"</b>			
24.5-32	T418	Forestry equipment	256
30.5L-32	T418		258
30.5L-32	T418 HP		258
DH 35.5L-32	T418		258
DH 35.5L-32	T418 HP		258

Size	Tread pattern	Application	Page
<b>34"</b>			
16.9-34	TM90	Tractors	112
18.4-34	TM90		112
420/85-34	T410	Forestry equipment	242
460/85-34	T410		242
600/65-34 LS2	T440 SB		252
710/55-34 LS2	T440 SB		252
600/65-34	T440 LS2 SB		238
620/60B-34	T459	Agro industrial equipment	238
<b>36"</b>			
12.4-36	TM90	Tractors	113
<b>38"</b>			
15.5-38	TM90	Tractors	114
16.9-38	TM90		114
18.4-38	TM90		114
20.8-38	TM90		115
710/65-38	T414	Forestry equipment	124
850/50-38	T414		124
850/60-38	T414		124
420/85-38	T410		242
460/85-38	T410		242
520/85-38	T410		242
<b>42"</b>			
850/55-42	T414	Forestry equipment	124

# Light Service tires

Size	PR/LI	Tread pattern	Application	Page
<b>4"</b>				
3.00-4	4	T991	Crop processing and green area equipment	194
3.00-4	6	T991		194
3.00-4	6	T530		194
4.00-4	6	T991		195
4.10-4	4	T510		195
4.10/3.50-4	6	T539		195
11x4.00-4	2	T537S TL		195
100/100-4	60A8 48A8	T539		196
<b>6"</b>				
3.50-6	4	T510	Crop processing and green area equipment	196
100/85-6	46	T513		199
4.10/3.50-6	57J	T533 HS		197
4.00-6	6	T991		196
13x5.00-6	4	T539 TL		197
13x5.00-6	6	T539 TL		198
13x5.00-6	4	T510 TL		198
13x5.00-6	6	T510		198
13x5.00-6	2	GARDENER		197
15x6.00-6	4	T510 TL		199
15x6.00-6	6	T510 TT		199
15x6.00-6	4	T539 Grip TL		198
15x6.00-6	2	GARDENER TL		198
100/65-6	24A8	T539 Grip TL		199
140-6	6	T539		200
140-6	10	T510		200
<b>8"</b>				
3.00-8	2	T539 Grey	Crop processing and green area equipment	201
3.50-8	4	T510		201
3.50-8	4	T513		201
3.50-8	56J	T501 HS		201
4.00-8	4	T63 TL		201
4.00-8	4	T510		201
4.00-8	4	T991		201
4.00-8	4	T513		201

Size	PR/LI	Tread pattern	Application	Page
<b>8"</b>				
4.00-8	6	T991	Crop processing and green area equipment	201
4.00-8	6	T522		201
4.00-8	8	T523		202
4.00-8	71J	T49 HS		202
5.00-8	6	T522		202
16x6.50-8	4	T539 Grip TL		202
16x6.50-8	6	T539		202
16x6.50-8	73A8	T310		202
16x6.50-8	84A8 80B	T510		203
16x6.50-8	2/49A6	GARDENER TL		203
16x6.50-8	84	T310		203
16.5x6.50-8	64J	T539 HS TL		203
16.5x6.50-8	72J	T539 HS TL		204
16x7.50-8	4	T537 TL		204
16x7.50-8	4/70A6	T539 TL		204
18x7.50-8	2	T539 TL		204
18x8.50-8	4	T539 TL	205	
18x8.50-8	6	T539	205	
18x8.50-8	6	T510	205	
18x8.50-8	8	T570 TL	206	
18x8.50-8	8	T415 TL	206	
18x8.50-8	2/58A6	GARDENER TL	204	
18x9.50-8	4	T521 GT TL	206	
18x9.50-8	4/82A6	DRIVER TL	206	
20x8.00-8	4	T539 TL	206	
20x10.00-8	2	GARDENER	206	
20x10.00-8	6	T539	207	
170/60-8	47A8 35A8	HIGH GRIP TL	207	
190-8	8	T537	207	
200/65-8	59A8 47A8	HIGH GRIP TL	208	
210/60-8	83A8	T415 TL	209	
220/45-8	70A8 58A8	T510	208	
220/45-8	70A8 58A8	T310	208	

Size	PR/LI	Tread pattern	Application	Page	
<b>8"</b>					
220/60-8	74A8 62A8	T463 Plus TL	Crop processing and green area equipment	209	
220/60-8	83	T510		209	
<b>9"</b>					
6.00-9	6	T522	Crop processing and green area equipment	210	
6.00-9	10	T991		210	
6.00-9	99J	T523 HS		210	
<b>10"</b>					
4.40-10	62J	T690 HS	Crop processing and green area equipment	210	
5.0-10	8	T462 TL		211	
7.50-10	12	T991		211	
7.50-10	14	T523 TL		211	
18x8.50-10	8	T570 TL		211	
20x8.00-10	4	T539 GT TL		212	
20x8.00-10	6	T539 TL		212	
20x8.00-10	8	T570 TL		212	
20x10.00-10	6	T539 TL		212	
20.5x8.00-10	10	T539 TL		212	
110/100-10	84A8 72A8	T560 ICE TL		212	
200/55-10	95A8	T430 TL		213	
250/50-10	79A8 67A8	HIGH GRIP TL		213	
<b>12"</b>					
6-12	4	T63 TL		Crop processing and green area equipment	213
10.0/75-12	10	T446 TL	213		
23x8.50-12	4	T463 TL	213		
23x8.50-12	104	T463 TL	214		
23x8.50-12	6	T550 TL	214		
23x8.50-12	10	T539	214		
23x8.50-12	10	T539 Grey	215		
23x10.50-12	4	T463 TL	215		
23x10.50-12	4	T539 TL	216		
23x10.50-12	6	T539 TL	216		
23x10.50-12	6	T539 Grey TL	216		
23x10.50-12	6/100A6	DRIVER TL	217		

Size	PR/LI	Tread pattern	Application	Page
<b>12"</b>				
23x12.50-12	6	T539 TL	Crop processing and green area equipment	217
26x12.00-12	8	T539 TL		218
26x12.00-12	8	T539 TT		218
26x12.00-12	4	T411 TL		218
26x12.00-12	8	T463 TL		219
220/60-12	88A8	T539 Soft		219
(23x8.50-12)	76A8	Grip TL		219
300/65-12	118A8	T446 TL		219
320/60-12	132A8	T421 TT/TL		219
320/60-12	132A8	T421 Grey TL		220
560x140-12	100	T528	220	
<b>13"</b>				
23x5	10	T94 TL	Crop processing and green area equipment	220
(23x5.00-13)				
610x145-13	112	T528	220	
<b>14"</b>				
645x160-14	120	T528	Crop processing and green area equipment	220
<b>14.5"</b>				
200/60-14.5	10	T448 Extra	Crop processing and green area equipment	220
200/60-14.5	10	T536		
<b>15"</b>				
7.00-15	6	TRACTION	Crop processing and green area equipment	221
11L-15	12	T510 TL		221
29x12.50-15	4	T411		221
29x12.50-15	90	T463		221
29x13.50-15	4	T411		221
31x15.50-15	8	T412 TL		221
33x12.50-15	6	T413 TL		221
33x15.50-15	6	T412 TL		221
33x15.50-15	8	T412 TL		221
320/70-15	122A8	T539 Soft Grip TL		222
320/55-15	123A8	T559 Turf Grip TL		222
320/55-15	133A8 121A8	T421 TL		222
380/60-15	114A8	T539 Soft Grip TL		223
400/50-15	135A8	T463 TL		223
690x180-15	100A8	TRACTION		223

# Range and applications

Range	TM1000 Progressive Traction®	TM1000 High Power	TM900 High Power	TM1060	TM800	TM800 High Speed	TM700 Progressive Traction®	TM700	TM700 High Speed	TM600	TM150	TM100	
HP (for FWD tractor single fitment)	270-450	270-450	250-400	80-300	80-260	120-260	100-240	40-240	120-180	50-180			
HP (for Articulated 4WD single fitment)	400-600	400-600	350-550	80-320									
Max Speed (Km/h)	70	65	70	70	65	70	65	50-65	70	50	65	40	
Construction	Radial	Radial	Radial	Radial	Radial	Radial	Radial	Radial	Radial	Radial	Radial	Radial	
TRACTOR SERVICE	Field application (High torque value)	●	●	●	●	●	○	●	●	○	●		
	Field application (Medium torque value)	●	●	●	●	●	○	●	●	○	●		
	Field-bed preparation (Low torque value)	●	●	●	●	●	○	●	●	○	○		
	Transport on road (High speed)	●	●	●	●	●	●	●		●			
	Transport on road (Max 50 Km/h)	●	●	●	●	●	●	●	○	●	○		
	High load on front axels	●	●	●	●		●			●			
	IF - High Flexion Technology (* )		●										
	VF - Very High Flexion Technology (* * )	●			●							●	
	Orchard - Vineyard								●		○		
	Water-logged and Marshy terrain												
	Row Crop cultivation										○	●	●
	Grassland												
	IMPLEMENT SERVICE	Harvesting											
Forestry													
Self propelled machine													
Trailer on road													
Trailer on field													
Implement machine													
AGRO INDUSTRIAL SERVICE	Telehandler Backhoe Loader Compact Wheel Loader												
	Agriculture truck												

● Suggested - ○ Permitted

\* IF Improved Flexion = up to 20% more load at the same pressure versus standard technology

\*\* VF Very High Flexion = up to 40% more load at the same pressure versus standard technology

HP range = refers to nominal rims

TM190	Marshland	TM3000	TM2000	HF1000	Twin Radial	TM90	Twin Tractor	Twin Implement	Twin AMPT	Twin Forestry	Agro Forest	Implement Standard	Light Service	TH400 TH500 Agrolndustrial	MPT100	TB40 Backhoe
30-80						25-160*	150-310				80-200					
							350-450									
50	50	40	40	70	70	40	50	50	70	40	50	50	40-70	50	50	40
Radial	Radial	Radial	Radial	Radial	Radial	Radial	Cross-Ply	Cross-Ply	Cross-Ply	Cross-Ply	Cross-Ply	Cross-Ply	Cross-Ply	Radial	Radial	Cross-Ply
●		○	○			●	●				●					
●		○	○			●	●				●					
●		○	○			○	●				○					
○						○										
							●									
		●														
						○							●			
○	●					○										
●				●	●			●					●			
		●	●				●	○								
		○	○	●	●			●	●	●	○					
				●	●			○	●			○	○			
		○		●	●			●	●			●	●			
				●	●			●	●			●	●			
														●	●	○
														○	○	●

\* For 180 hp tractors please contact Trelleborg

# TM1000 ProgressiveTraction®



Trelleborg is modernizing its leading tire line, the TM1000, enriching the tread with ProgressiveTraction® technology, which has won numerous innovation awards around the world and has brought great improvements to the market. The new TM1000 ProgressiveTraction®, designed in compliance with VF regulations, is an innovative tire capable of providing superior load capacity, reducing soil



compaction, while providing unbeatable traction. On the road, the new range guarantees high performance, increasing machine productivity.

	SIZE	
NEW	VF 540/65R30 TL	158D (155E)
	VF 600/70R30 TL	170D (167E)
NEW	VF 620/75R30 TL	172D (169E)
	VF 420/85R34 TL	154D
NEW	VF 650/60R34 TL	168D (165E)
NEW	VF 710/60R34 TL	173D (170E)
NEW	VF 650/65R34 TL	170D (167E)
NEW	VF 650/65R38 TL	172D (169E)
NEW	VF 650/85R38 TL	182D (179E)
	VF 710/60R38 TL	174D (171E)
	VF 800/70R38 TL	184D

	SIZE	
NEW	VF 650/65R42 TL	174D (171E)
NEW	VF 650/75R42 TL	180D (177E)
NEW	VF 650/85R42 TL	183D (180E)
NEW	VF 710/70R42 TL	182D (179E)
NEW	VF 710/75R42 TL	184D (181E)
NEW	VF 900/60R42 TL	189D (186E)
NEW	VF 380/85R46 TL	162D (159E)
NEW	VF 750/75R46 TL	189D (186E)
	VF 900/65R46 TL	193D (190E)
	VF 480/80R50 TL	166D
NEW	VF 480/95R54 TL	180D (177E)



SIZE	Tread pattern	SW mm	OD mm	SLR mm	RC mm	SRI	Rim	Permitted Rims	Type	Tube	
<b>VF 540/65R30</b> 158D (155E)	<b>TM1000</b> ProgressiveTraction®	540	1480	635	4450	700	W18L	DW18L - TW18L DW16L	TUBELESS		
<b>PRESSURE</b>											
<b>psi</b>		<b>6</b>	<b>9</b>	<b>12</b>	<b>14</b>	<b>17</b>	<b>20</b>	<b>23</b>	<b>26</b>	<b>29</b>	
<b>bar</b>		<b>0,4</b>	<b>0,6</b>	<b>0,8</b>	<b>1,0</b>	<b>1,2</b>	<b>1,4</b>	<b>1,6</b>	<b>1,8</b>	<b>2,0</b>	
<b>MAX. LOAD kg</b>											
70 S						2590	2940	3210	3480	3675	3875
<b>40 to 65 S</b>						2850	3230	3530	3825	4040	<b>4250</b>
30 S					2560	2905	3295	3600	3900	4120	4335
20 S				2255	2610	2960	3360	3670	3980	4200	4420
10 LT (*)		1990	2385	2760	3130	3555	3880	4210	4440	4675	
10 HT (**)			2210	2560	2905	3295	3600	3900	4120	4335	

SIZE	Tread pattern	SW mm	OD mm	SLR mm	RC mm	SRI	Rim	Permitted Rims	Type	Tube			
<b>VF 600/70R30</b> 170D (167E)	<b>TM1000</b> ProgressiveTraction®	615	1600	695	4785	750	DW21B	DW20B	TUBELESS				
<b>PRESSURE</b>													
<b>psi</b>		<b>6</b>	<b>9</b>	<b>12</b>	<b>14</b>	<b>17</b>	<b>20</b>	<b>23</b>	<b>26</b>	<b>29</b>	<b>32</b>	<b>35</b>	
<b>bar</b>		<b>0,4</b>	<b>0,6</b>	<b>0,8</b>	<b>1,0</b>	<b>1,2</b>	<b>1,4</b>	<b>1,6</b>	<b>1,8</b>	<b>2,0</b>	<b>2,2</b>	<b>2,4</b>	
<b>MAX. LOAD kg</b>													
70 S					3385	3820	4260	4695	4915	5130	5295	5450	
<b>40 to 65 S</b>					3720	4200	4680	5160	5400	5640	5820	<b>6000</b>	
30 S				3305	3795	4285	4775	5265	5510	5755	5935	6120	
20 S				2935	3370	3870	4370	4865	5365	5615	5865	6055	6240
10 LT (*)		2490	2990	3435	3945	4450	4960	5470	5725	5980	6170	6360	
10 HT (**)			2875	3305	3795	4285	4775	5265	5510	5755	5935	6120	

SIZE	Tread pattern	SW mm	OD mm	SLR mm	RC mm	SRI	Rim	Permitted Rims	Type	Tube	
<b>VF 620/75R30</b> 172D (169E)	<b>TM1000</b> ProgressiveTraction®	640	1670	715	4945	800	DW23B	TW23B - DW21B DW20B	TUBELESS		
<b>PRESSURE</b>											
<b>psi</b>		<b>6</b>	<b>9</b>	<b>12</b>	<b>14</b>	<b>17</b>	<b>20</b>	<b>23</b>	<b>26</b>	<b>29</b>	
<b>bar</b>		<b>0,4</b>	<b>0,6</b>	<b>0,8</b>	<b>1,0</b>	<b>1,2</b>	<b>1,4</b>	<b>1,6</b>	<b>1,8</b>	<b>2,0</b>	
<b>MAX. LOAD kg</b>											
70 S						3785	4300	4760	5215	5475	5800
<b>40 to 65 S</b>						4160	4725	5230	5735	6015	<b>6300</b>
30 S					3725	4240	4820	5335	5850	6135	6425
20 S				3275	3800	4325	4915	5440	5960	6255	6550
10 LT (*)		2890	3465	4020	4575	5200	5750	6305	6620	6930	
10 HT (**)			3215	3725	4240	4820	5335	5850	6135	6425	

### TM1000 ProgressiveTraction®

Radial tire for tractors, sprayers and spreaders



SIZE	Tread pattern	SW mm	OD mm	SLR mm	RC mm	SRI	Rim	Permitted Rims	Type	Tube
VF 420/85R34 154D	TM1000 ProgressiveTraction®	445	1585	670	4735	750	DW15L	DW14L	TUBELESS	
<b>PRESSURE</b>										
psi			<b>6</b>	<b>9</b>	<b>12</b>	<b>14</b>	<b>17</b>	<b>20</b>	<b>23</b>	<b>23</b>
bar			<b>0,4</b>	<b>0,6</b>	<b>0,8</b>	<b>1,0</b>	<b>1,2</b>	<b>1,4</b>	<b>1,6</b>	<b>1,6</b>
<b>MAX. LOAD kg</b>										
<b>40 to 65 S</b>							2740	3075	3415	<b>3750</b>
30 S						2450	2790	3135	3480	3825
20 S				2145		2495	2845	3200	3550	3900
10 LT (*)			1890		2270	2640	3010	3385	3755	4125
10 HT (**)				2105		2450	2790	3135	3480	3825

SIZE	Tread pattern	SW mm	OD mm	SLR mm	RC mm	SRI	Rim	Permitted Rims	Type	Tube	
VF 650/60R34 168D (165E)	TM1000 ProgressiveTraction®	650	1670	740	4960	775	DW23B	MW23	TUBELESS		
<b>PRESSURE</b>											
psi			<b>6</b>	<b>9</b>	<b>12</b>	<b>14</b>	<b>17</b>	<b>20</b>	<b>23</b>	<b>26</b>	<b>29</b>
bar			<b>0,4</b>	<b>0,6</b>	<b>0,8</b>	<b>1,0</b>	<b>1,2</b>	<b>1,4</b>	<b>1,6</b>	<b>1,8</b>	<b>2,0</b>
<b>MAX. LOAD kg</b>											
70 S						3415	3875	4230	4585	4840	5150
<b>40 to 65 S</b>						3750	4255	4650	5040	5320	<b>5600</b>
30 S					3370	3825	4340	4740	5140	5425	5710
20 S				2970	3435	3900	4425	4835	5240	5535	5825
10 LT (*)			2615	3140	3635	4125	4680	5115	5545	5850	6160
10 HT (**)				2915	3370	3825	4340	4740	5140	5425	5710

SIZE	Tread pattern	SW mm	OD mm	SLR mm	RC mm	SRI	Rim	Permitted Rims	Type	Tube	
VF710/60R34 173D (170E)	TM1000 ProgressiveTraction®	710	1715	750	5125	825	DW25B	TW25-DW23 NRO	TUBELESS		
<b>PRESSURE</b>											
psi			<b>6</b>	<b>9</b>	<b>12</b>	<b>14</b>	<b>17</b>	<b>20</b>	<b>23</b>	<b>26</b>	<b>29</b>
bar			<b>0,4</b>	<b>0,6</b>	<b>0,8</b>	<b>1,0</b>	<b>1,2</b>	<b>1,4</b>	<b>1,6</b>	<b>1,8</b>	<b>2,0</b>
<b>MAX. LOAD kg</b>											
70 S						3965	4495	4910	5325	5620	6000
<b>40 to 65 S</b>						4355	4940	5395	5850	6175	<b>6500</b>
30 S					3910	4440	5040	5505	5965	6300	6630
20 S				3450	3990	4530	5140	5610	6085	6420	6760
10 LT (*)			3040	3645	4220	4790	5435	5935	6435	6795	7150
10 HT (**)				3380	3910	4440	5040	5505	5965	6300	6630

SIZE	Tread pattern	SW mm	OD mm	SLR mm	RC mm	SRI	Rim	Permitted Rims	Type	Tube	
VF 650/65R34 170D (167E)	TM1000 ProgressiveTraction®	660	1720	755	5085	825	DW23B		TUBELESS		
<b>PRESSURE</b>											
psi		<b>6</b>	<b>9</b>	<b>12</b>	<b>14</b>	<b>17</b>	<b>20</b>	<b>23</b>	<b>26</b>	<b>29</b>	
bar		<b>0,4</b>	<b>0,6</b>	<b>0,8</b>	<b>1,0</b>	<b>1,2</b>	<b>1,4</b>	<b>1,6</b>	<b>1,8</b>	<b>2,0</b>	
<b>MAX. LOAD kg</b>											
70 S						3660	4150	4530	4915	5185	5450
<b>40 to 65 S</b>						4020	4560	4980	5400	5700	<b>6000</b>
30 S					3610	4100	4650	5080	5510	5815	6120
20 S				3180	3680	4180	4740	5180	5615	5930	6240
10 LT (*)		2805		3365	3895	4420	5015	5480	5940	6270	6600
10 HT (**)				3120	3610	4100	4650	5080	5510	5815	6120

SIZE	Tread pattern	SW mm	OD mm	SLR mm	RC mm	SRI	Rim	Permitted Rims	Type	Tube	
VF 650/65R38 172D (169E)	TM1000 ProgressiveTraction®	670	1830	800	5480	875	DW23B	DW21B - TW23B	TUBELESS		
<b>PRESSURE</b>											
psi		<b>6</b>	<b>9</b>	<b>12</b>	<b>14</b>	<b>17</b>	<b>20</b>	<b>23</b>	<b>26</b>	<b>29</b>	
bar		<b>0,4</b>	<b>0,6</b>	<b>0,8</b>	<b>1,0</b>	<b>1,2</b>	<b>1,4</b>	<b>1,6</b>	<b>1,8</b>	<b>2,0</b>	
<b>MAX. LOAD kg</b>											
70 S						3840	4355	4760	5160	5445	5800
<b>40 to 65 S</b>						4220	4790	5230	5670	5985	<b>6300</b>
30 S					3790	4305	4885	5335	5785	6105	6425
20 S				3340	3865	4390	4980	5440	5895	6225	6550
10 LT (*)		2945		3535	4090	4645	5265	5750	6235	6585	6930
10 HT (**)				3275	3790	4305	4885	5335	5785	6105	6425

Design data = the dimensions of size in design data are calculated dimensions and not measured data on the normal production tire

SIZE	Tread pattern	SW mm	OD mm	SLR mm	RC mm	SRI	Rim	Permitted Rims	Type	Tube	
VF 650/85R38 182D (179E)	TM1000 ProgressiveTraction®	680	2085	900	6225	975	DW23B	DW21B	TUBELESS		
<b>PRESSURE</b>											
psi		<b>6</b>	<b>9</b>	<b>12</b>	<b>14</b>	<b>17</b>	<b>20</b>	<b>23</b>	<b>26</b>	<b>29</b>	
bar		<b>0,4</b>	<b>0,6</b>	<b>0,8</b>	<b>1,0</b>	<b>1,2</b>	<b>1,4</b>	<b>1,6</b>	<b>1,8</b>	<b>2,0</b>	
<b>MAX. LOAD kg</b>											
70 S						5105	5800	6420	7040	7385	7750
<b>40 to 65 S</b>						5610	6375	7055	7735	8120	<b>8500</b>
30 S					5030	5720	6505	7195	7890	8280	8670
20 S				4420	5125	5835	6630	7335	8045	8440	8840
10 LT (*)		3895		4675	5425	6170	7015	7760	8510	8930	9350
10 HT (**)				4335	5030	5720	6505	7195	7890	8280	8670

### TM1000 ProgressiveTraction®

Radial tire for tractors, sprayers and spreaders



SIZE	Tread pattern	SW mm	OD mm	SLR mm	RC mm	SRI	Rim	Permitted Rims	Type	Tube	
VF 710/60R38 174D (171E)	TM1000 ProgressiveTraction®	710	1840	805	5505	875	DW25B	TW25B	TUBELESS		
<b>PRESSURE</b>											
psi		<b>6</b>	<b>9</b>	<b>12</b>	<b>14</b>	<b>17</b>	<b>20</b>	<b>23</b>	<b>26</b>	<b>29</b>	
bar		<b>0,4</b>	<b>0,6</b>	<b>0,8</b>	<b>1,0</b>	<b>1,2</b>	<b>1,4</b>	<b>1,6</b>	<b>1,8</b>	<b>2,0</b>	
<b>MAX. LOAD kg</b>											
70 S						4085	4635	5060	5485	5790	6150
<b>40 to 65 S</b>						4490	5090	5560	6030	6365	<b>6700</b>
30 S					4030	4580	5195	5670	6150	6490	6835
20 S				3555	4110	4670	5295	5785	6270	6620	6970
10 LT (*)		3135	3760	4350	4940	5600	6115	6635	7000	7370	
10 HT (**)			3485	4030	4580	5195	5670	6150	6490	6835	

SIZE	Tread pattern	SW mm	OD mm	SLR mm	RC mm	SRI	Rim	Permitted Rims	Type	Tube
VF 800/70R38 184D	TM1000 ProgressiveTraction®	830	2078	860	6200	975	DW27B	DW25B	TUBELESS	
<b>PRESSURE</b>										
psi		<b>6</b>	<b>9</b>	<b>12</b>	<b>14</b>	<b>17</b>	<b>20</b>	<b>23</b>	<b>26</b>	<b>29</b>
bar		<b>0,4</b>	<b>0,6</b>	<b>0,8</b>	<b>1,0</b>	<b>1,2</b>	<b>1,4</b>	<b>1,6</b>	<b>1,8</b>	<b>2,0</b>
<b>MAX. LOAD kg</b>										
<b>40 to 65 S</b>							6570	7380	8190	<b>9000</b>
30 S						5875	6700	7530	8355	9180
20 S				5150	5990	6835	7675	8520	9360	
10 LT (*)		4370	5245	6105	6965	7825	8680	9540		
10 HT (**)			5050	5875	6700	7530	8355	9180		

SIZE	Tread pattern	SW mm	OD mm	SLR mm	RC mm	SRI	Rim	Permitted Rims	Type	Tube	
VF 650/65R42 174D (171E)	TM1000 ProgressiveTraction®	665	1935	845	5810	925	DW23B	DW21B - DW20B (NRO)	TUBELESS		
<b>PRESSURE</b>											
psi		<b>6</b>	<b>9</b>	<b>12</b>	<b>14</b>	<b>17</b>	<b>20</b>	<b>23</b>	<b>26</b>	<b>29</b>	
bar		<b>0,4</b>	<b>0,6</b>	<b>0,8</b>	<b>1,0</b>	<b>1,2</b>	<b>1,4</b>	<b>1,6</b>	<b>1,8</b>	<b>2,0</b>	
<b>MAX. LOAD kg</b>											
70 S						4085	4635	5060	5485	5790	6150
<b>40 to 65 S</b>						4490	5090	5560	6030	6365	<b>6700</b>
30 S					4030	4580	5195	5670	6150	6490	6835
20 S				3555	4110	4670	5295	5785	6270	6620	6970
10 LT (*)		3135	3760	4350	4940	5600	6115	6635	7000	7370	
10 HT (**)			3485	4030	4580	5195	5670	6150	6490	6835	

SIZE	Tread pattern	SW mm	OD mm	SLR mm	RC mm	SRI	Rim	Permitted Rims	Type	Tube
<b>VF 650/75R42</b> 180D (177E)	<b>TM1000</b> ProgressiveTraction®	670	2065	900	6160	975	DW23B		TUBELESS	
<b>PRESSURE</b>										
<b>psi</b>		<b>6</b>	<b>9</b>	<b>12</b>	<b>14</b>	<b>17</b>	<b>20</b>	<b>23</b>	<b>26</b>	<b>29</b>
<b>bar</b>		<b>0,4</b>	<b>0,6</b>	<b>0,8</b>	<b>1,0</b>	<b>1,2</b>	<b>1,4</b>	<b>1,6</b>	<b>1,8</b>	<b>2,0</b>
<b>MAX. LOAD kg</b>										
70 S						4805	5460	6040	6625	6950 7300
<b>40 to 65 S</b>						5280	6000	6640	7280	<b>8000</b>
30 S					4735	5385	6120	6775	7425	7795 8160
20 S				4160	4825	5490	6240	6905	7570	7945 8320
10 LT (*)		3665		4400	5105	5810	6600	7305	8010	8405 8800
10 HT (**)				4080	4735	5385	6120	6775	7425	7795 8160

SIZE	Tread pattern	SW mm	OD mm	SLR mm	RC mm	SRI	Rim	Permitted Rims	Type	Tube
<b>VF650/85R42</b> 183D (180E)	<b>TM1000</b> ProgressiveTraction®	680	2175	955	6450	1025	DW23B	DW21B	TUBELESS	
<b>PRESSURE</b>										
<b>psi</b>		<b>6</b>	<b>9</b>	<b>12</b>	<b>14</b>	<b>17</b>	<b>20</b>	<b>23</b>	<b>26</b>	<b>29</b>
<b>bar</b>		<b>0,4</b>	<b>0,6</b>	<b>0,8</b>	<b>1,0</b>	<b>1,2</b>	<b>1,4</b>	<b>1,6</b>	<b>1,8</b>	<b>2,0</b>
<b>MAX. LOAD kg</b>										
70 S						5255	5970	6610	7245	7605 8000
<b>40 to 65 S</b>						5775	6565	7265	7965	<b>8355 8750</b>
30 S					5175	5890	6695	7410	8120	8525 8925
20 S				4550	5280	6005	6825	7555	8280	8690 9100
10 LT (*)		4015		4815	5585	6355	7220	7990	8760	9190 9625
10 HT (**)				4465	5175	5890	6695	7410	8120	8525 8925

SIZE	Tread pattern	SW mm	OD mm	SLR mm	RC mm	SRI	Rim	Permitted Rims	Type	Tube
<b>VF 710/70R42</b> 182D (179E)	<b>TM1000</b> ProgressiveTraction®	740	2070	900	6190	975	DW25B	DW23B	TUBELESS	
<b>PRESSURE</b>										
<b>psi</b>		<b>6</b>	<b>9</b>	<b>12</b>	<b>14</b>	<b>17</b>	<b>20</b>	<b>23</b>	<b>26</b>	<b>29</b>
<b>bar</b>		<b>0,4</b>	<b>0,6</b>	<b>0,8</b>	<b>1,0</b>	<b>1,2</b>	<b>1,4</b>	<b>1,6</b>	<b>1,8</b>	<b>2,0</b>
<b>MAX. LOAD kg</b>										
70 S						5105	5800	6420	7040	7385 7750
<b>40 to 65 S</b>						5610	6375	7055	7735	<b>8120 8500</b>
30 S					5030	5720	6505	7195	7890	8280 8670
20 S				4420	5125	5835	6630	7335	8045	8440 8840
10 LT (*)		3895		4675	5425	6170	7015	7760	8510	8930 9350
10 HT (**)				4335	5030	5720	6505	7195	7890	8280 8670



SIZE	Tread pattern	SW mm	OD mm	SLR mm	RC mm	SRI	Rim	Permitted Rims	Type	Tube
<b>VF 710/75R42</b> 184D (181E)	<b>TM1000</b> ProgressiveTraction®	740	2160	935	6400	1000	DW25B	DW23B	TUBELESS	

#### PRESSURE

psi	<b>6</b>	<b>9</b>	<b>12</b>	<b>14</b>	<b>17</b>	<b>20</b>	<b>23</b>	<b>26</b>	<b>29</b>
bar	<b>0,4</b>	<b>0,6</b>	<b>0,8</b>	<b>1,0</b>	<b>1,2</b>	<b>1,4</b>	<b>1,6</b>	<b>1,8</b>	<b>2,0</b>

#### MAX. LOAD kg

70 S					5405	6145	6800	7455	7820	8250
<b>40 to 65 S</b>					5940	6750	7470	8190	8595	<b>9000</b>
30 S				5325	6060	6885	7620	8355	8765	9180
20 S			4680	5430	6180	7020	7770	8520	8940	9360
10 LT (*)	4125	4950	5740	6535	7425	8215	9010	9455	9900	
10 HT (**)		4590	5325	6060	6885	7620	8355	8765	9180	

**Design data** = the dimensions of size in design data are calculated dimensions and not measured data on the normal production tire

SIZE	Tread pattern	SW mm	OD mm	SLR mm	RC mm	SRI	Rim	Permitted Rims	Type	Tube
<b>VF 900/60R42</b> 189D (186E)	<b>TM1000</b> ProgressiveTraction®	883	2150	910,5	6445	1025	DW30B	DW28B - TW30B	TUBELESS	

#### PRESSURE

psi	<b>6</b>	<b>9</b>	<b>12</b>	<b>14</b>	<b>17</b>	<b>20</b>	<b>23</b>	<b>26</b>	<b>29</b>
bar	<b>0,4</b>	<b>0,6</b>	<b>0,8</b>	<b>1,0</b>	<b>1,2</b>	<b>1,4</b>	<b>1,6</b>	<b>1,8</b>	<b>2,0</b>

#### MAX. LOAD kg

70 S					6280	7125	7780	8435	8905	9500
<b>40 to 65 S</b>					6900	7830	8550	9270	9785	<b>10300</b>
30 S				6200	7040	7985	8720	9455	9980	10505
20 S			5465	6320	7175	8140	8890	9640	10175	10710
10 LT (*)	4815	5780	6685	7590	8610	9405	10195	10765	11330	
10 HT (**)		5360	6200	7040	7985	8720	9455	9980	10505	

**Design data** = the dimensions of size in design data are calculated dimensions and not measured data on the normal production tire

SIZE	Tread pattern	SW mm	OD mm	SLR mm	RC mm	SRI	Rim	Permitted Rims	Type	Tube				
<b>VF 380/85R46</b> 162D (159E)	<b>TM1000</b> ProgressiveTraction®	360	1825	830	5490	875	DW12	W12 - DW13 - W13	TUBELESS					
<b>PRESSURE</b>														
psi		<b>6</b>	<b>9</b>	<b>12</b>	<b>15</b>	<b>17</b>	<b>20</b>	<b>23</b>	<b>26</b>	<b>29</b>	<b>32</b>	<b>35</b>	<b>41</b>	
bar		<b>0,4</b>	<b>0,6</b>	<b>0,8</b>	<b>1,0</b>	<b>1,2</b>	<b>1,4</b>	<b>1,6</b>	<b>1,8</b>	<b>2,0</b>	<b>2,2</b>	<b>2,4</b>	<b>2,8</b>	
<b>MAX. LOAD kg</b>														
70 S					2465	2765	3070	3370	3545	3715	3825	3935	4375	
<b>40 to 65 S</b>					2705	3040	3375	3705	3895	4085	4205	4325	<b>4750</b>	
30 S				2425	2760	3100	3440	3780	3975	4165	4290	4410	4845	
20 S				2125	2470	2815	3160	3505	3855	4050	4250	4370	4495	4940
10 LT (*)		1870	2245	2615	2980	3345	3710	4075	4285	4495	4625	4755	5225	
10 HT (**)			2085	2425	2760	3100	3440	3780	3975	4165	4290	4410	4845	

SIZE	Tread pattern	SW mm	OD mm	SLR mm	RC mm	SRI	Rim	Permitted Rims	Type	Tube	
<b>VF 750/75R46</b> 189D (186E)	<b>TM1000</b> ProgressiveTraction®	760	2285	993	6850	1125	DW25B		TUBELESS		
<b>PRESSURE</b>											
psi		<b>6</b>	<b>9</b>	<b>12</b>	<b>14</b>	<b>17</b>	<b>20</b>	<b>23</b>	<b>26</b>	<b>29</b>	
bar		<b>0,4</b>	<b>0,6</b>	<b>0,8</b>	<b>1,0</b>	<b>1,2</b>	<b>1,4</b>	<b>1,6</b>	<b>1,8</b>	<b>2,0</b>	
<b>MAX. LOAD kg</b>											
70 S						6185	7030	7780	8530	8950	9500
<b>40 to 65 S</b>						6800	7725	8550	9375	9835	<b>10300</b>
30 S					6095	6935	7880	8720	9560	10035	10505
20 S				5355	6215	7070	8035	8890	9750	10230	10710
10 LT (*)		4720	5665	6570	7480	8500	9405	10310	10820	11330	
10 HT (**)			5255	6095	6935	7880	8720	9560	10035	10505	



SIZE	Tread pattern	SW mm	OD mm	SLR mm	RC mm	SRI	Rim	Permitted Rims	Type	Tube	
<b>VF 900/65R46</b> 193D (190E)	<b>TM1000</b> ProgressiveTraction®	890	2330	1010	6910	1165	DW30B		TUBELESS		
<b>PRESSURE</b>											
<b>psi</b>		<b>6</b>	<b>9</b>	<b>12</b>	<b>14</b>	<b>17</b>	<b>20</b>	<b>23</b>	<b>26</b>	<b>29</b>	
<b>bar</b>		<b>0,4</b>	<b>0,6</b>	<b>0,8</b>	<b>1,0</b>	<b>1,2</b>	<b>1,4</b>	<b>1,6</b>	<b>1,8</b>	<b>2,0</b>	
<b>MAX. LOAD kg</b>											
70 S						7010	7955	8685	9420	9940	10600
<b>40 to 65 S</b>						7705	8740	9545	10350	10925	<b>11500</b>
30 S					6920	7860	8915	9735	10555	11145	11730
20 S				6100	7055	8015	9090	9925	10765	11360	11960
10 LT (*)		5375		6450	7465	8475	9615	10500	11385	12020	12650
10 HT (**)				5980	6920	7860	8915	9735	10555	11145	11730

**Design data** = the dimensions of size in design data are calculated dimensions and not measured data on the normal production tire

SIZE	Tread pattern	SW mm	OD mm	SLR mm	RC mm	SRI	Rim	Permitted Rims	Type	Tube
<b>VF 480/80R50</b> 166D	<b>TM1000</b> ProgressiveTraction®	480	2050	905	6140	975	DW16L	DW15L	TUBELESS	
<b>PRESSURE</b>										
<b>psi</b>		<b>6</b>	<b>9</b>	<b>12</b>	<b>14</b>	<b>17</b>	<b>20</b>	<b>23</b>		
<b>bar</b>		<b>0,4</b>	<b>0,6</b>	<b>0,8</b>	<b>1,0</b>	<b>1,2</b>	<b>1,4</b>	<b>1,6</b>		
<b>MAX. LOAD kg</b>										
<b>40 to 65 S</b>							3870	4345	4825	<b>5300</b>
30 S						3460	3945	4435	4920	5405
20 S				3030		3530	4025	4520	5015	5510
10 LT (*)			2670	3205		3730	4255	4780	5305	5830
10 HT (**)				2975		3460	3945	4435	4920	5405



SIZE	Tread pattern	SW mm	OD mm	SLR mm	RC mm	SRI	Rim	Permitted Rims	Type	Tube			
<b>VF 480/95R54</b> 180D (177E)	<b>TM1000</b> ProgressiveTraction®	480	2295	1040	6865	1125	DW15L	TW15L	TUBELESS				
<b>PRESSURE</b>													
<b>psi</b>		<b>6</b>	<b>9</b>	<b>12</b>	<b>15</b>	<b>17</b>	<b>20</b>	<b>23</b>	<b>26</b>	<b>29</b>	<b>32</b>	<b>35</b>	<b>41</b>
<b>bar</b>		<b>0,4</b>	<b>0,6</b>	<b>0,8</b>	<b>1,0</b>	<b>1,2</b>	<b>1,4</b>	<b>1,6</b>	<b>1,8</b>	<b>2,0</b>	<b>2,2</b>	<b>2,4</b>	<b>2,8</b>
<b>MAX. LOAD kg</b>													
70 S					4150	4660	5170	5680	5970	6260	6445	6625	7300
<b>40 to 65 S</b>					4560	5120	5680	6240	6560	6880	7080	7280	<b>8000</b>
30 S				4080	4650	5220	5795	6365	6690	7020	7220	7425	8160
20 S			3580	4160	4740	5325	5905	6490	6820	7155	7365	7570	8320
10 LT (*)		3155	3785	4400	5015	5630	6250	6865	7215	7570	7790	8010	8800
10 HT (**)			3510	4080	4650	5220	5795	6365	6690	7020	7220	7425	8160

For technical notes about pressure tables please refer to page 260.

### TM1000 ProgressiveTraction®

Radial tire for tractors, sprayers and spreaders



# TM1000 HIGH POWER



Constant and smooth torque transfer in the field, unbeatable traction in the furrow, low rolling resistance and a very long life on the road come together to make TM1000 High Power an efficient solution for high powered tractors.

The carcass, engineered with **BLUE TIRE** technology, ensures premium farming productivity by providing an extra wide foot-print and

low soil compaction. Developed to fully respect the environment, the TM1000 High Power is the perfect solution for sustainable farming.

## SIZE

**IF 600/70R30 159D**

**IF 650/60R34 159D**

**IF 650/65R38 169D**

**IF 710/70R42 179D**

**IF 900/60R42 180D**

SIZE	Tread pattern	SW mm	OD mm	SLR mm	RC mm	SRI	Rim	Permitted Rims	Type	Tube
IF 600/70R30 159D	TM1000 HP	605	1610	695	4750	750	DW21B	DW20B	TUBELESS	

### PRESSURE

psi	6	9	12	14	17	20	23	26	28
bar	0,4	0,6	0,8	1,0	1,2	1,4	1,6	1,8	1,9

### MAX. LOAD kg

<b>40 to 65 S</b>				2800	3195	3590	3985	<b>4375</b>		
30 S				2910	3320	3730	4140	4550		
20 S				3025	3450	3875	4300	4725		
10 LT (*)	2335	2790		3250	3705	4160	4620	5075	5380	5555
10 HT				2910	3320	3730	4140	4550		

SIZE	Tread pattern	SW mm	OD mm	SLR mm	RC mm	SRI	Rim	Permitted Rims	Type	Tube
IF 650/60R34 159D	TM1000 HP	645	1660	725	4955	775	DW23B	MW23	TUBELESS	
<b>PRESSURE</b>										
psi		<b>6</b>	<b>9</b>	<b>12</b>	<b>14</b>	<b>17</b>	<b>20</b>	<b>23</b>	<b>26</b>	<b>28</b>
bar		<b>0,4</b>	<b>0,6</b>	<b>0,8</b>	<b>1,0</b>	<b>1,2</b>	<b>1,4</b>	<b>1,6</b>	<b>1,8</b>	<b>1,9</b>
<b>MAX. LOAD kg</b>										
<b>40 to 65 S</b>					2800	3195	3590	3985	<b>4375</b>	
30 S					2910	3320	3730	4140	4550	
20 S					3025	3450	3875	4300	4725	
10 LT (*)		2335	2790		3250	3705	4160	4620	5075	5380 5555
10 HT					2910	3320	3730	4140	4550	

SIZE	Tread pattern	SW mm	OD mm	SLR mm	RC mm	SRI	Rim	Permitted Rims	Type	Tube				
IF 650/65R38 169D	TM1000 HP	660	1840	830	5510	875	DW23B		TUBELESS					
<b>PRESSURE</b>														
psi		<b>6</b>	<b>9</b>	<b>12</b>	<b>14</b>	<b>17</b>	<b>20</b>	<b>23</b>	<b>26</b>	<b>29</b>	<b>32</b>	<b>35</b>	<b>38</b>	<b>41</b>
bar		<b>0,4</b>	<b>0,6</b>	<b>0,8</b>	<b>1,0</b>	<b>1,2</b>	<b>1,4</b>	<b>1,6</b>	<b>1,8</b>	<b>2,0</b>	<b>2,2</b>	<b>2,4</b>	<b>2,6</b>	<b>2,8</b>
<b>MAX. LOAD kg</b>														
<b>40 to 65 S</b>					3190	3655	4060	4470	4815	5105	5395	5600	<b>5800</b>	
30 S					3320	3800	4220	4645	5005	5310	5610	5820	6030	
20 S					3445	3945	4385	4825	5200	5510	5825	6045	6265	
10 LT (*)		2625	3160	3700	4240	4710	5180	5585	5920	6255	6495	6730	7020	7365
10 HT					3320	3800	4220	4645	5005	5310	5610	5820	6030	

SIZE	Tread pattern	SW mm	OD mm	SLR mm	RC mm	SRI	Rim	Permitted Rims	Type	Tube				
IF 710/70R42 179D	TM1000 HP	735	2060	920	6190	975	DW25B		TUBELESS					
<b>PRESSURE</b>														
psi		<b>6</b>	<b>9</b>	<b>12</b>	<b>14</b>	<b>17</b>	<b>20</b>	<b>23</b>	<b>26</b>	<b>29</b>	<b>32</b>	<b>35</b>	<b>38</b>	<b>41</b>
bar		<b>0,4</b>	<b>0,6</b>	<b>0,8</b>	<b>1,0</b>	<b>1,2</b>	<b>1,4</b>	<b>1,6</b>	<b>1,8</b>	<b>2,0</b>	<b>2,2</b>	<b>2,4</b>	<b>2,6</b>	<b>2,8</b>
<b>MAX. LOAD kg</b>														
<b>40 to 65 S</b>					4185	4805	5425	6045	6665	6940	7210	7480	<b>7750</b>	
30 S					4350	4995	5640	6285	6930	7255	7575	7820	8060	
20 S					4520	5190	5860	6530	7200	7535	7870	8120	8370	
10 LT (*)		3595	4225	4855	5575	6295	7010	7730	8090	8450	8720	8990	9380	9845
10 HT					4350	4995	5640	6285	6930	7255	7575	7820	8060	

## TM1000 HIGH POWER

Radial tire for tractors, sprayers and spreaders



SIZE	Tread pattern	SW mm	OD mm	SLR mm	RC mm	SRI	Rim	Permitted Rims	Type	Tube
IF 900/60R42 180D	TM1000 HP	880	2155	945	6425	1025	DW30B	DW28B	TUBELESS	
<b>PRESSURE</b>										
psi		<b>6</b>	<b>9</b>	<b>12</b>	<b>14</b>	<b>17</b>	<b>20</b>	<b>23</b>	<b>26</b>	<b>28</b>
bar		<b>0,4</b>	<b>0,6</b>	<b>0,8</b>	<b>1,0</b>	<b>1,2</b>	<b>1,4</b>	<b>1,6</b>	<b>1,8</b>	<b>1,9</b>
<b>MAX. LOAD kg</b>										
<b>40 to 65 S</b>					5120	5840	6560	7280	<b>8000</b>	
30 S					5325	6075	6820	7570	8320	
20 S					5530	6305	7085	7860	8640	
10 LT (*)		4270	5105		5940	6775	7610	8445	9280	9840 10160
10 HT					5325	6075	6820	7570	8320	

For technical notes about pressure tables please refer to page 260.

## TM1000 HIGH POWER



# TM900 HIGH POWER



Due to its dimensional characteristics and its optimized radial structure, the TM900 High Power is able to transfer to the ground the high torque of the biggest agricultural vehicles, generating a great traction on all kind of soils.

It also assures outstanding road performances in terms of comfort and safety.

SIZE		
600/70R28	157D	(154E)
600/70R30	158D	(155E)
710/60R30	162D	(159E)
600/70R34	160D	(157E)
650/60R34	159D	(156E)
710/55R34	164D	(161E)
710/60R34	164D	(161E)
650/75R38	169D	(166E)

SIZE		
650/85R38	173D	(170E)
800/70R38	178D	(175E)
900/60R38	178D	(175E)
710/70R42	173D	(170E)
710/70R42 Harvester	173D	(170E)
710/70R42	179A8	*
710/75R42	175D	(172E)
900/60R42	180D	(177E)

\* For harvesting applications

SIZE	Tread pattern	SW mm	OD mm	SLR mm	RC mm	SRI	Rim	Permitted Rims	Type	Tube
600/70R28 157D (154E)	TM900 HP	604	1551	699	4720	725	DW18L	DW20B	TUBELESS	

## PRESSURE

psi	9	12	14	17	20	23	29	35
bar	0,6	0,8	1,0	1,2	1,4	1,6	2,0	2,4

## MAX. LOAD kg

70 S				2325	2625	2925	3225	3525	3750
65 S				2560	2890	3220	3550	3880	4125
50 S	2040	2340	2690	3035	3380	3725	4075	4335	
40 S	2125	2440	2805	3165	3525	3885	4250	4520	
30 S	2230	2565	2945	3325	3705	4080	4460	4745	
10 LT S	2615	3005	3445	3890	4335	4780	5225	5560	
10 HT S	2230	2565	2945	3325	3705	4080	4460	4745	

## TM900 HIGH POWER

Radial tire for tractors and harvesters



SIZE	Tread pattern	SW mm	OD mm	SLR mm	RC mm	SRI	Rim	Permitted Rims	Type	Tube
<b>600/70R30</b> 158D (155E)	<b>TM900 HP</b>	605	1608	722	4820	750	DW18L	DW20B	TUBELESS	
<b>PRESSURE</b>										
<b>psi</b>		<b>9</b>	<b>12</b>	<b>14</b>	<b>17</b>	<b>20</b>	<b>23</b>	<b>29</b>	<b>35</b>	
<b>bar</b>		<b>0,6</b>	<b>0,8</b>	<b>1,0</b>	<b>1,2</b>	<b>1,4</b>	<b>1,6</b>	<b>2,0</b>	<b>2,4</b>	
<b>MAX. LOAD kg</b>										
70 S					2405	2715	3025	3335	3645	3875
<b>65 S</b>					2635	2975	3315	3655	3995	<b>4250</b>
50 S		2100	2410	2770	3125	3485	3840	4195	4465	
40 S		2190	2515	2890	3260	3630	4005	4375	4655	
30 S		2300	2640	3035	3425	3815	4205	4595	4890	
10 LT S		2695	3095	3555	4015	4470	4930	5390	5730	
10 HT S		2300	2640	3035	3425	3815	4205	4595	4890	

SIZE	Tread pattern	SW mm	OD mm	SLR mm	RC mm	SRI	Rim	Permitted Rims	Type	Tube
<b>710/60R30</b> 162D (159E)	<b>TM900 HP</b>	710	1590	720	4800	775	DW23B		TUBELESS	
<b>PRESSURE</b>										
<b>psi</b>		<b>9</b>	<b>12</b>	<b>14</b>	<b>17</b>	<b>20</b>	<b>23</b>	<b>29</b>	<b>35</b>	
<b>bar</b>		<b>0,6</b>	<b>0,8</b>	<b>1,0</b>	<b>1,2</b>	<b>1,4</b>	<b>1,6</b>	<b>2,0</b>	<b>2,4</b>	
<b>MAX. LOAD kg</b>										
70 S					2670	2975	3325	3630	4070	4375
<b>65 S</b>					2900	3230	3610	3945	4420	<b>4750</b>
50 S		2295	2645	3045	3395	3795	4140	4640	4990	
40 S		2395	2760	3175	3540	3955	4320	4840	5205	
30 S		2515	2900	3335	3715	4155	4535	5085	5465	
10 LT S		2945	3395	3905	4355	4865	5315	5955	6400	
10 HT S		2515	2900	3335	3715	4155	4535	5085	5465	

SIZE	Tread pattern	SW mm	OD mm	SLR mm	RC mm	SRI	Rim	Permitted Rims	Type	Tube
<b>600/70R34</b> 160D (157E)	<b>TM900 HP</b>	600	1685	755	5105	800	DW18L	DW20B - W18L	TUBELESS	
<b>PRESSURE</b>										
<b>psi</b>		<b>9</b>	<b>12</b>	<b>14</b>	<b>17</b>	<b>20</b>	<b>23</b>	<b>29</b>	<b>35</b>	
<b>bar</b>		<b>0,6</b>	<b>0,8</b>	<b>1,0</b>	<b>1,2</b>	<b>1,4</b>	<b>1,6</b>	<b>2,0</b>	<b>2,4</b>	
<b>MAX. LOAD kg</b>										
70 S					2540	2865	3195	3550	3850	4125
<b>65 S</b>					2790	3150	3510	3875	4230	<b>4500</b>
50 S		2220	2550	2930	3310	3685	4000	4440	4750	
40 S		2315	2660	3055	3450	3845	4250	4630	5000	
30 S		2430	2795	3210	3625	4035	4500	4865	5150	
10 LT S		2765	3175	3645	4185	4725	5265	5800	6300	
10 HT S		2430	2795	3210	3625	4035	4500	4865	5150	

SIZE	Tread pattern	SW mm	OD mm	SLR mm	RC mm	SRI	Rim	Permitted Rims	Type	Tube
<b>650/60R34</b> 159D (156E)	<b>TM900 HP</b>	645	1650	750	4965	775	DW20B	DW18L - MW23	TUBELESS	
<b>PRESSURE</b>										
<b>psi</b>		<b>9</b>	<b>12</b>	<b>14</b>	<b>17</b>	<b>20</b>	<b>23</b>	<b>29</b>	<b>35</b>	
<b>bar</b>		<b>0,6</b>	<b>0,8</b>	<b>1,0</b>	<b>1,2</b>	<b>1,4</b>	<b>1,6</b>	<b>2,0</b>	<b>2,4</b>	
<b>MAX. LOAD kg</b>										
70 S					2440	2720	3040	3320	3720	4000
<b>65 S</b>					2670	2975	3325	3635	4070	<b>4375</b>
50 S		2115	2435	2805	3125	3495	3815	4275	4595	
40 S		2205	2540	2925	3260	3645	3980	4460	4795	
30 S		2315	2670	3070	3425	3825	4180	4680	5035	
10 LT S		2715	3125	3595	4010	4480	4895	5485	5895	
10 HT S		2315	2670	3070	3425	3825	4180	4680	5035	

SIZE	Tread pattern	SW mm	OD mm	SLR mm	RC mm	SRI	Rim	Permitted Rims	Type	Tube
<b>710/55R34</b> 164D (161E)	<b>TM900 HP</b>	712	1633	752	4970	775	DW23B		TUBELESS	
<b>PRESSURE</b>										
<b>psi</b>		<b>12</b>	<b>14</b>	<b>17</b>	<b>20</b>	<b>23</b>	<b>29</b>	<b>35</b>	<b>41</b>	
<b>bar</b>		<b>0,8</b>	<b>1,0</b>	<b>1,2</b>	<b>1,4</b>	<b>1,6</b>	<b>2,0</b>	<b>2,4</b>	<b>2,8</b>	
<b>MAX. LOAD kg</b>										
70 S					2875	3195	3515	3925	4225	4565
<b>65 S</b>					3150	3500	3850	4300	4625	<b>5000</b>
50 S		2605	2975	3350	3720	4090	4570	4915	5310	
40 S		2690	3070	3455	3840	4220	4715	5070	5480	
30 S		2855	3260	3670	4075	4485	5010	5385	5820	
10 LT S		3310	3780	4255	4725	5200	5805	6245	6750	
10 HT S		2855	3260	3670	4075	4485	5010	5385	5820	

SIZE	Tread pattern	SW mm	OD mm	SLR mm	RC mm	SRI	Rim	Permitted Rims	Type	Tube
<b>710/60R34</b> 164D (161E)	<b>TM900 HP</b>	715	1700	775	5125	825	DW23B		TUBELESS	
<b>PRESSURE</b>										
<b>psi</b>		<b>9</b>	<b>12</b>	<b>14</b>	<b>17</b>	<b>20</b>	<b>23</b>	<b>29</b>	<b>35</b>	
<b>bar</b>		<b>0,6</b>	<b>0,8</b>	<b>1,0</b>	<b>1,2</b>	<b>1,4</b>	<b>1,6</b>	<b>2,0</b>	<b>2,4</b>	
<b>MAX. LOAD kg</b>										
70 S					2825	3145	3515	3840	4305	4625
<b>65 S</b>					3050	3400	3800	4150	4650	<b>5000</b>
50 S		2415	2785	3205	3570	3990	4360	4885	5250	
40 S		2520	2905	3340	3725	4165	4545	5095	5475	
30 S		2645	3050	3510	3910	4370	4775	5350	5750	
10 LT S		3100	3570	4110	4580	5120	5595	6265	6735	
10 HT S		2645	3050	3510	3910	4370	4775	5350	5750	

## TM900 HIGH POWER

Radial tire for tractors and harvesters



SIZE	Tread pattern	SW mm	OD mm	SLR mm	RC mm	SRI	Rim	Permitted Rims	Type	Tube
<b>650/75R38</b> 169D (166E)	<b>TM900 HP</b>	676	1940	855	5840	925	DW23B		TUBELESS	
<b>PRESSURE</b>										
<b>psi</b>		<b>9</b>	<b>12</b>	<b>14</b>	<b>17</b>	<b>20</b>	<b>23</b>	<b>29</b>	<b>35</b>	
<b>bar</b>		<b>0,6</b>	<b>0,8</b>	<b>1,0</b>	<b>1,2</b>	<b>1,4</b>	<b>1,6</b>	<b>2,0</b>	<b>2,4</b>	
<b>MAX. LOAD kg</b>										
70 S					3290	3710	4135	4560	4985	5300
<b>65 S</b>					3600	4060	4525	4990	5455	<b>5800</b>
50 S		2865	3290	3780	4265	4755	5240	5725	6090	
40 S		2985	3430	3940	4450	4955	5465	5970	6355	
30 S		3135	3605	4140	4670	5205	5740	6270	6670	
10 LT S		3675	4225	4850	5475	6100	6725	7350	7820	
10 HT S		3135	3605	4140	4670	5205	5740	6270	6670	

SIZE	Tread pattern	SW mm	OD mm	SLR mm	RC mm	SRI	Rim	Permitted Rims	Type	Tube
<b>650/85R38</b> 173D (170E)	<b>TM900 HP</b>	709	2070	910	6245	975	DW23B		TUBELESS	
<b>PRESSURE</b>										
<b>psi</b>		<b>9</b>	<b>12</b>	<b>14</b>	<b>17</b>	<b>20</b>	<b>23</b>	<b>29</b>	<b>35</b>	
<b>bar</b>		<b>0,6</b>	<b>0,8</b>	<b>1,0</b>	<b>1,2</b>	<b>1,4</b>	<b>1,6</b>	<b>2,0</b>	<b>2,4</b>	
<b>MAX. LOAD kg</b>										
70 S					3720	4200	4680	5160	5640	6000
<b>65 S</b>					4030	4550	5070	5590	6110	<b>6500</b>
50 S		3210	3690	4235	4780	5325	5870	6420	6825	
40 S		3350	3845	4415	4985	5555	6125	6695	7120	
30 S		3515	4040	4635	5235	5835	6430	7030	7475	
10 LT S		4120	4735	5435	6135	6835	7535	8235	8760	
10 HT S		3515	4040	4635	5235	5835	6430	7030	7475	

SIZE	Tread pattern	SW mm	OD mm	SLR mm	RC mm	SRI	Rim	Permitted Rims	Type	Tube
<b>800/70R38</b> 178D (175E)	<b>TM900 HP</b>	810	2065	910	6205	975	DW25B	DW27B	TUBELESS	
<b>PRESSURE</b>										
<b>psi</b>		<b>9</b>	<b>12</b>	<b>14</b>	<b>17</b>	<b>20</b>	<b>23</b>	<b>29</b>	<b>35</b>	
<b>bar</b>		<b>0,6</b>	<b>0,8</b>	<b>1,0</b>	<b>1,2</b>	<b>1,4</b>	<b>1,6</b>	<b>2,0</b>	<b>2,4</b>	
<b>MAX. LOAD kg</b>										
70 S					4210	4695	5245	5730	6420	6900
<b>65 S</b>					4575	5100	5700	6225	6975	<b>7500</b>
50 S		3625	4175	4805	5355	5985	6540	7325	7875	
40 S		3780	4355	5010	5585	6245	6820	7640	8215	
30 S		3970	4575	5265	5865	6555	7160	8025	8625	
10 LT S		4650	5355	6165	6870	7680	8390	9400	10110	
10 HT S		3970	4575	5265	5865	6555	7160	8025	8625	



SIZE	Tread pattern	SW mm	OD mm	SLR mm	RC mm	SRI	Rim	Permitted Rims	Type	Tube
<b>900/60R38</b> 178D (175E)	<b>TM900 HP</b>	905	2040	915	6180	975	DW28B	DW27B - DW30B	TUBELESS	
<b>PRESSURE</b>										
<b>psi</b>		<b>9</b>	<b>12</b>	<b>14</b>	<b>17</b>	<b>20</b>	<b>23</b>	<b>29</b>	<b>35</b>	
<b>bar</b>		<b>0,6</b>	<b>0,8</b>	<b>1,0</b>	<b>1,2</b>	<b>1,4</b>	<b>1,6</b>	<b>2,0</b>	<b>2,4</b>	
<b>MAX. LOAD kg</b>										
70 S					4210	4695	5245	5730	6420	6900
<b>65 S</b>					4575	5100	5700	6225	6975	<b>7500</b>
50 S		3625	4175	4805	5355	5985	6540	7325	7875	
40 S		3780	4355	5010	5585	6245	6820	7640	8215	
30 S		3970	4575	5265	5865	6555	7160	8025	8625	
10 LT S		4650	5355	6165	6870	7680	8390	9400	10105	
10 HT S		3970	4575	5265	5865	6555	7160	8025	8625	

SIZE	Tread pattern	SW mm	OD mm	SLR mm	RC mm	SRI	Rim	Permitted Rims	Type	Tube
<b>710/70R42</b> 173D (170E)	<b>TM900 HP</b>	716	2061	910	6190	975	DW23B	DW25B	TUBELESS	
<b>PRESSURE</b>										
<b>psi</b>		<b>9</b>	<b>12</b>	<b>14</b>	<b>17</b>	<b>20</b>	<b>23</b>	<b>29</b>	<b>35</b>	
<b>bar</b>		<b>0,6</b>	<b>0,8</b>	<b>1,0</b>	<b>1,2</b>	<b>1,4</b>	<b>1,6</b>	<b>2,0</b>	<b>2,4</b>	
<b>MAX. LOAD kg</b>										
70 S					3720	4200	4680	5160	5640	6000
<b>65 S</b>					4030	4550	5070	5590	6110	<b>6500</b>
50 S		3210	3690	4235	4780	5325	5870	6420	6825	
40 S		3350	3845	4415	4985	5555	6125	6695	7120	
30 S		3515	4040	4635	5235	5835	6430	7030	7475	
10 LT S		4120	4735	5435	6135	6835	7535	8235	8760	
10 HT S		3515	4040	4635	5235	5835	6430	7030	7475	

SIZE	Tread pattern	SW mm	OD mm	SLR mm	RC mm	SRI	Rim	Permitted Rims	Type	Tube
<b>710/70R42</b> 173D (170E)	<b>TM900 HP</b> Harvester	732	2040	900	6120	975	DW23B	DW25B	TUBELESS	
<b>PRESSURE</b>										
<b>psi</b>		<b>9</b>	<b>12</b>	<b>14</b>	<b>17</b>	<b>20</b>	<b>23</b>	<b>29</b>	<b>35</b>	
<b>bar</b>		<b>0,6</b>	<b>0,8</b>	<b>1,0</b>	<b>1,2</b>	<b>1,4</b>	<b>1,6</b>	<b>2,0</b>	<b>2,4</b>	
<b>MAX. LOAD kg</b>										
70S					3720	4200	4680	5160	5640	6000
<b>65 S</b>					4030	4550	5070	5590	6110	<b>6500</b>
50 S		3210	3690	4235	4780	5325	5870	6420	6825	
40 S		3350	3845	4415	4985	5555	6125	6695	7120	
30 S		3515	4040	4635	5235	5835	6430	7030	7475	
10 LT S		4120	4735	5435	6135	6835	7535	8235	8760	
10 HT S		3515	4040	4635	5235	5835	6430	7030	7475	

## TM900 HIGH POWER

Radial tire for tractors and harvesters



SIZE	Tread pattern	SW mm	OD mm	SLR mm	RC mm	SRI	Rim	Permitted Rims	Type	Tube		
<b>710/70R42</b> 179A8	<b>TM900 HP</b>	725	2070	915	6280	975	DW23B	DW25B	TUBELESS			
<b>PRESSURE</b>												
<b>psi</b>		<b>12</b>	<b>14</b>	<b>17</b>	<b>20</b>	<b>23</b>	<b>29</b>	<b>35</b>	<b>41</b>	<b>46</b>	<b>49</b>	<b>55</b>
<b>bar</b>		<b>0,8</b>	<b>1,0</b>	<b>1,2</b>	<b>1,4</b>	<b>1,6</b>	<b>2,0</b>	<b>2,4</b>	<b>2,8</b>	<b>3,2</b>	<b>3,4</b>	<b>3,8</b>
<b>MAX. LOAD kg</b>												
<b>40 S</b>		3705	4165	4605	5055	5485	6030	6575	7165	<b>7750</b>		
30 S		3965	4455	4930	5410	5870	6450	7035	7665	8295		
10 LT S		4590	5160	5875	6595	7260	8430	9250	10080	10695	11190	11625
10 HT S		3965	4455	4930	5410	5870	6450	7035	7665	8295		
10 Cyc S			5850	6660	7475	8230	9555	10485	11425	12430	12685	13175

For harvesting applications

SIZE	Tread pattern	SW mm	OD mm	SLR mm	RC mm	SRI	Rim	Permitted Rims	Type	Tube		
<b>710/75R42</b> 175D (172E)	<b>TM900 HP</b>	720	2140	945	6415	1000	DW23B	DW25B	TUBELESS			
<b>PRESSURE</b>												
<b>psi</b>		<b>9</b>	<b>12</b>	<b>14</b>	<b>17</b>	<b>20</b>	<b>23</b>	<b>29</b>	<b>35</b>			
<b>bar</b>		<b>0,6</b>	<b>0,8</b>	<b>1,0</b>	<b>1,2</b>	<b>1,4</b>	<b>1,6</b>	<b>2,0</b>	<b>2,4</b>			
<b>MAX. LOAD kg</b>												
70 S					3910	4410	4915	5400	5900	6300		
<b>65 S</b>					4280	4830	5385	5935	6485	<b>6900</b>		
50 S		3405	3910	4490	5070	5650	6230	6810	7300			
40 S		3550	4080	4685	5290	5895	6500	7100	7750			
30 S		3730	4285	4920	5555	6190	6825	7460	8000			
10 LT S		4235	4865	5590	6415	7245	8075	8900	9750			
10 HT S		3730	4285	4920	5555	6190	6825	7460	8000			

SIZE	Tread pattern	SW mm	OD mm	SLR mm	RC mm	SRI	Rim	Permitted Rims	Type	Tube		
<b>900/60R42</b> 180D (177E)	<b>TM900 HP</b>	905	2140	960	6425	1025	DW28B	DW27B - DW30B	TUBELESS			
<b>PRESSURE</b>												
<b>psi</b>		<b>9</b>	<b>12</b>	<b>14</b>	<b>17</b>	<b>20</b>	<b>23</b>	<b>29</b>	<b>35</b>			
<b>bar</b>		<b>0,6</b>	<b>0,8</b>	<b>1,0</b>	<b>1,2</b>	<b>1,4</b>	<b>1,6</b>	<b>2,0</b>	<b>2,4</b>			
<b>MAX. LOAD kg</b>												
70 S					4455	4965	5550	6060	6790	7300		
<b>65 S</b>					4880	5440	6080	6640	7440	<b>8000</b>		
50 S		3865	4455	5125	5715	6385	6975	7815	8400			
40 S		4030	4645	5345	5960	6660	7275	8150	8760			
30 S		4235	4880	5615	6260	6995	7640	8560	9200			
10 LT S		4960	5715	6575	7330	8190	8945	10025	10780			
10 HT S		4235	4880	5615	6260	6995	7640	8560	9200			

For technical notes about pressure tables please refer to page 260.

## TM900 HIGH POWER

Radial tire for tractors and harvesters



# TM1060

BLUE  TIRE  
TECHNOLOGY



On the field the TM1060, with ProgressiveTraction® tread, provides superior traction capacity and reduced working time, operating costs and fuel expenses. Capable of working at extremely low pressure, with the typical aspect ratio of a 60 series, the TM1060 generates an extra wide footprint area providing premium respect for the soil, farm productivity and crop yield.

On the road, the new sidewall design significantly lowers rolling resistance, fuel consumption and emissions, while increasing stress tolerance, comfort and security for the operator.

## SIZE

<b>VF 480/60R28</b>	<b>145D</b>
<b>VF 520/60R28 NRO</b>	<b>149D</b>
<b>VF 600/60R28 NRO</b>	<b>157D</b>
<b>VF 600/60R30 NRO</b>	<b>158D</b>
<b>VF 600/60R38</b>	<b>168D (165E)</b>

## SIZE

<b>VF 650/60R38 NRO</b>	<b>166D</b>
<b>VF 650/60R38 NRO</b>	<b>173D (170E)</b>
<b>VF 710/60R38 NRO</b>	<b>171D</b>
<b>VF 710/60R42 NRO</b>	<b>173D (170E)</b>
<b>VF 750/70R44</b>	<b>183D</b>

SIZE	Tread pattern	SW mm	OD mm	SLR mm	RC mm	SRI	Rim	Permitted Rims NRO	Type	Tube
<b>VF 480/60R28</b> 145D	<b>TM1060</b>	480	1295	554	3850	625	DW16L	W16L	TUBELESS	

### PRESSURE

<b>psi</b>	<b>9</b>	<b>12</b>	<b>14</b>	<b>17</b>	<b>20</b>	<b>23</b>
<b>bar</b>	<b>0,6</b>	<b>0,8</b>	<b>1,0</b>	<b>1,2</b>	<b>1,4</b>	<b>1,6</b>

### MAX. LOAD kg

<b>40 to 65 S</b>		1855	2115	2380	2640	<b>2900</b>
30 S	1625	1895	2160	2425	2690	2960
20 S	1660	1930	2200	2475	2745	3015
10 LT	1755	2040	2330	2615	2905	3190
10 HT (*)	1625	1895	2160	2425	2690	2960

NRO = Narrow Rim Option

**Design data** = the dimensions of size in design data are calculated dimensions and not measured data on the normal production tire

## TM1060

Radial tire for tractors



SIZE	Tread pattern	SW mm	OD mm	SLR mm	RC mm	SRI	Rim	Permitted Rims NRO	Type	Tube	
<b>VF 520/60R28</b> 149D	<b>TM1060</b>	520	1340	575	3985	650	DW18L	W18L - DW16L W16L	TUBELESS		
<b>PRESSURE</b>											
<b>psi</b>		<b>9</b>		<b>12</b>		<b>14</b>		<b>17</b>		<b>20</b>	<b>23</b>
<b>bar</b>		<b>0,6</b>		<b>0,8</b>		<b>1,0</b>		<b>1,2</b>		<b>1,4</b>	<b>1,6</b>
<b>MAX. LOAD kg</b>											
<b>40 to 65 S</b>				2080		2375		2665		2960	<b>3250</b>
30 S		1825		2120		2420		2720		3015	3315
20 S		1860		2165		2465		2770		3075	3380
10 LT		1965		2290		2610		2930		3255	3575
10 HT (*)		1825		2120		2420		2720		3015	3315

NRO = Narrow Rim Option

SIZE	Tread pattern	SW mm	OD mm	SLR mm	RC mm	SRI	Rim	Permitted Rims NRO	Type	Tube	
<b>VF 600/60R28</b> 157D	<b>TM1060</b>	600	1420	605	4205	675	DW20B	DW18L - DW21B	TUBELESS		
<b>PRESSURE</b>											
<b>psi</b>		<b>9</b>		<b>12</b>		<b>14</b>		<b>17</b>		<b>20</b>	<b>23</b>
<b>bar</b>		<b>0,6</b>		<b>0,8</b>		<b>1,0</b>		<b>1,2</b>		<b>1,4</b>	<b>1,6</b>
<b>MAX. LOAD kg</b>											
<b>40 to 65 S</b>				2640		3015		3385		3755	<b>4125</b>
30 S		2315		2695		3070		3450		3830	4210
20 S		2360		2745		3130		3520		3905	4290
10 LT		2495		2905		3310		3720		4130	4540
10 HT (*)		2315		2695		3070		3450		3830	4210

NRO = Narrow Rim Option

SIZE	Tread pattern	SW mm	OD mm	SLR mm	RC mm	SRI	Rim	Permitted Rims NRO	Type	Tube	
<b>VF 600/60R30</b> 158D	<b>TM1060</b>	595	1490	625	4420	700	DW20B	DW18L - DW21B	TUBELESS		
<b>PRESSURE</b>											
<b>psi</b>		<b>9</b>		<b>12</b>		<b>14</b>		<b>17</b>		<b>20</b>	<b>23</b>
<b>bar</b>		<b>0,6</b>		<b>0,8</b>		<b>1,0</b>		<b>1,2</b>		<b>1,4</b>	<b>1,6</b>
<b>MAX. LOAD kg</b>											
<b>40 to 65 S</b>				2720		3105		3485		3870	<b>4250</b>
30 S		2385		2775		3165		3555		3945	4335
20 S		2430		2830		3225		3625		4020	4420
10 LT		2570		2990		3415		3835		4255	4675
10 HT (*)		2385		2775		3165		3555		3945	4335

NRO = Narrow Rim Option

SIZE	Tread pattern	SW mm	OD mm	SLR mm	RC mm	SRI	Rim	Permitted Rims NRO	Type	Tube
<b>VF 600/60R38</b> 168D (165E)	<b>TM1060</b>	605	1683	746	5050	800	DW20B	DW18L	TUBELESS	

#### PRESSURE

psi	<b>9</b>	<b>12</b>	<b>14</b>	<b>17</b>	<b>20</b>	<b>23</b>	<b>26</b>	<b>29</b>	<b>32</b>	<b>35</b>
bar	<b>0,6</b>	<b>0,8</b>	<b>1,0</b>	<b>1,2</b>	<b>1,4</b>	<b>1,6</b>	<b>1,8</b>	<b>2,0</b>	<b>2,2</b>	<b>2,4</b>

#### MAX. LOAD kg

70 S			2700	3110	3465	3875	4230	4485	4740	4890	5150
<b>40 to 65 S</b>			2970	3415	3810	4255	4650	4930	5210	5375	<b>5600</b>
30 S		2630	3025	3485	3885	4340	4740	5025	5310	5485	5710
20 S		2680	3085	3555	3960	4425	4835	5125	5415	5590	5825
10 LT S		2835	3265	3760	4190	4680	5115	5420	5730	5915	6160
10 HT S (*)		2630	3025	3485	3885	4340	4740	5025	5310	5485	5710

NRO = Narrow Rim Option

SIZE	Tread pattern	SW mm	OD mm	SLR mm	RC mm	SRI	Rim	Permitted Rims NRO	Type	Tube
<b>VF 650/60R38</b> 166D	<b>TM1060</b>	655	1735	755	5190	825	DW23B	MW23B - DW20B	TUBELESS	

#### PRESSURE

psi	<b>9</b>	<b>12</b>	<b>14</b>	<b>17</b>	<b>20</b>	<b>23</b>
bar	<b>0,6</b>	<b>0,8</b>	<b>1,0</b>	<b>1,2</b>	<b>1,4</b>	<b>1,6</b>

#### MAX. LOAD kg

<b>40 to 65 S</b>			3395	3870	4350	4825	<b>5300</b>
30 S		2975	3460	3945	4435	4920	5405
20 S		3030	3530	4025	4520	5015	5510
10 LT		3205	3730	4255	4780	5305	5830
10 HT S (*)		2975	3460	3945	4435	4920	5405

NRO = Narrow Rim Option

SIZE	Tread pattern	SW mm	OD mm	SLR mm	RC mm	SRI	Rim	Permitted Rims NRO	Type	Tube
<b>VF 650/60R38</b> 173D (170E)	<b>TM1060</b>	663	1744	755	5200	825	DW23B	MW23B - DW20B	TUBELESS	

#### PRESSURE

psi	<b>9</b>	<b>12</b>	<b>14</b>	<b>17</b>	<b>20</b>	<b>23</b>	<b>26</b>	<b>29</b>	<b>32</b>	<b>35</b>
bar	<b>0,6</b>	<b>0,8</b>	<b>1,0</b>	<b>1,2</b>	<b>1,4</b>	<b>1,6</b>	<b>1,8</b>	<b>2,0</b>	<b>2,2</b>	<b>2,4</b>

#### MAX. LOAD kg

70 S			3135	3610	4020	4495	4910	5205	5500	5680	5915
<b>40 to 65 S</b>			3445	3965	4420	4940	5395	5720	6045	6240	<b>6500</b>
30 S		3050	3515	4045	4510	5040	5505	5835	6165	6365	6630
20 S		3110	3585	4125	4595	5140	5610	5950	6285	6490	6760
10 LT S		3290	3790	4360	4860	5435	5935	6290	6650	6865	7150
10 HT S (*)		3050	3515	4045	4510	5040	5505	5835	6165	6365	6630

NRO = Narrow Rim Option

### TM1060

Radial tire for tractors



SIZE	Tread pattern	SW mm	OD mm	SLR mm	RC mm	SRI	Rim	Permitted Rims NRO	Type	Tube
<b>VF 710/60R38</b> 171D	<b>TM1060</b>	715	1820	785	5420	875	DW25B	MW25B - DW23B	TUBELESS	

#### PRESSURE

<b>psi</b>	<b>9</b>	<b>12</b>	<b>14</b>	<b>17</b>	<b>20</b>	<b>23</b>
<b>bar</b>	<b>0,6</b>	<b>0,8</b>	<b>1,0</b>	<b>1,2</b>	<b>1,4</b>	<b>1,6</b>

#### MAX. LOAD kg

<b>40 to 65 S</b>		3940	4490	5045	5600	<b>6150</b>
30 S	3450	4015	4580	5145	5710	6275
20 S	3520	4095	4670	5245	5820	6395
10 LT	3720	4330	4940	5545	6155	6765
10 HT (*)	3450	4015	4580	5145	5710	6275

NRO = Narrow Rim Option

SIZE	Tread pattern	SW mm	OD mm	SLR mm	RC mm	SRI	Rim	Permitted Rims NRO	Type	Tube
<b>VF 710/60R42</b> 173D	<b>TM1060</b>	715	1930	835	5735	925	DW25B	MW25B - DW23B	TUBELESS	

#### PRESSURE

<b>psi</b>	<b>9</b>	<b>12</b>	<b>14</b>	<b>17</b>	<b>20</b>	<b>23</b>
<b>bar</b>	<b>0,6</b>	<b>0,8</b>	<b>1,0</b>	<b>1,2</b>	<b>1,4</b>	<b>1,6</b>

#### MAX. LOAD kg

70 S		3785	4320	4850	5385	6000
<b>40 to 65 S</b>		4160	4745	5330	5915	<b>6500</b>
30 S	3645	4245	4840	5435	6035	6630
20 S	3720	4325	4935	5545	6150	6760
10 LT S	3935	4575	5220	5865	6505	7150
10 HT S (*)	3645	4245	4840	5435	6035	6630

NRO = Narrow Rim Option

SIZE	Tread pattern	SW mm	OD mm	SLR mm	RC mm	SRI	Rim	Permitted Rims NRO	Type	Tube
<b>VF 750/70R44</b> 183D	<b>TM1060</b>	770	2186	945	6465	1025	DW25B		TUBELESS	

#### PRESSURE

<b>psi</b>	<b>9</b>	<b>12</b>	<b>14</b>	<b>17</b>	<b>20</b>	<b>23</b>
<b>bar</b>	<b>0,6</b>	<b>0,8</b>	<b>1,0</b>	<b>1,2</b>	<b>1,4</b>	<b>1,6</b>

#### MAX. LOAD kg

<b>40 to 65 S</b>		5600	6390	7175	7965	<b>8750</b>
30 S	4910	5710	6515	7320	8120	8925
20 S	5005	5825	6645	7460	8280	9100
10 LT	5295	6160	7025	7890	8760	9625
10 HT (*)	4910	5710	6515	7320	8120	8925

NRO = Narrow Rim Option

For technical notes about pressure tables please refer to page 260.

### TM1060

Radial tire for tractors



# TM800



The TM800, one of the most successful product of our agricultural radial range, is D rated and able to reach 65 Km/h on the road at the nominal pressure of 1.6 bar. With its extra-large tread pattern it offers maximum performance in the field and it is able to carry heavy loads and to work at very low pressure.

Its winning feature is the excellent performance on the road in terms of stability, handling, comfort and long tire life.

## SIZE

**320/65R18 109A8 (109B)**

**340/65R18 113A8 (113B)**

**440/65R24 128D**

**480/65R24 133D**

**540/65R24 140D**

**540/65R24 146A8 \***

**540/65R26 141D**

**440/65R28 131D**

**480/65R28 136D**

**540/65R28 142D**

**540/65R28 142D** ProgressiveTraction® version

**600/65R28 147D**

**540/65R30 143D**

\* For harvesting applications

## SIZE

**540/65R34 145D**

**600/65R34 151D**

**540/65R38 147D**

**600/65R38 153D**

**650/65R38 157D**

**650/65R38 157D** ProgressiveTraction® version

**710/70R38 166D**

**710/70R38 166D** Sugar Cane

**710/70R38 171D** Sugar Cane

**710/70R38 175D** Forage

**600/65R42 154D**

**650/65R42 158D**

**650/65R42 165D (168A8)**



SIZE	Tread pattern	SW mm	OD mm	SLR mm	RC mm	SRI	Rim	Permitted Rims	Type	Tube
<b>320/65R18</b> 109A8 (109B)	<b>TM800</b>	310	871	388	2585	425	W9	W10 - W10.5 - W11	TUBELESS	

**PRESSURE**

**H**

psi	<b>9</b>	<b>12</b>	<b>14</b>	<b>17</b>	<b>20</b>	<b>23</b>	<b>26</b>	<b>28</b>	<b>30</b>
bar	<b>0,6</b>	<b>0,8</b>	<b>1,0</b>	<b>1,2</b>	<b>1,4</b>	<b>1,6</b>	<b>1,8</b>	<b>1,9</b>	<b>2,1</b>

**MAX. LOAD kg**

50 S		530	590	700	810	920	1030			
<b>40 S</b>		530	590	700	810	920	<b>1030</b>			
30 S		570	630	750	870	980	1100			
10 LT S		690	760	910	1060	1210	1360	1510	1550	1750
10 HT S		570	630	750	870	980	1100			

SIZE	Tread pattern	SW mm	OD mm	SLR mm	RC mm	SRI	Rim	Permitted Rims	Type	Tube
<b>340/65R18</b> 113A8 (113B)	<b>TM800</b>	320	900	396	2695	425	W9	W10 - W10.5 - W11	TUBELESS	

**PRESSURE**

**H**

psi	<b>9</b>	<b>12</b>	<b>14</b>	<b>17</b>	<b>20</b>	<b>23</b>	<b>26</b>	<b>28</b>	<b>30</b>
bar	<b>0,6</b>	<b>0,8</b>	<b>1,0</b>	<b>1,2</b>	<b>1,4</b>	<b>1,6</b>	<b>1,8</b>	<b>1,9</b>	<b>2,1</b>

**MAX. LOAD kg**

50 S		755	835	915	995	1070	1150			
<b>40 S</b>		755	835	915	995	1070	<b>1150</b>			
30 S		805	890	975	1060	1150	1230			
10 LT S		1030	1140	1250	1350	1460	1570	1680	1730	1960
10 HT S		805	890	975	1060	1150	1230			

SIZE	Tread pattern	SW mm	OD mm	SLR mm	RC mm	SRI	Rim	Permitted Rims	Type	Tube
<b>440/65R24</b> 128D	<b>TM800</b>	441	1182	537	3545	575	DW14L	W13 - W14L - W15L(°) DW13 - DW15L(°)	TUBELESS	14.9-24 TR218

**PRESSURE**

**H**

psi	<b>9</b>	<b>12</b>	<b>14</b>	<b>17</b>	<b>20</b>	<b>23</b>	<b>26</b>	<b>28</b>	<b>30</b>
bar	<b>0,6</b>	<b>0,8</b>	<b>1,0</b>	<b>1,2</b>	<b>1,4</b>	<b>1,6</b>	<b>1,8</b>	<b>1,9</b>	<b>2,1</b>

**MAX. LOAD kg**

<b>65 S</b>		1045	1210	1370	1515	1660	<b>1800</b>			
50 S		1100	1270	1440	1590	1740	1890			
40 S		1145	1325	1500	1660	1815	1975			
30 S		1205	1390	1575	1740	1905	2070			
10 LT S		1420	1645	1865	2060	2255	2450	2620	2700	3060
10 HT S		1205	1390	1575	1740	1905	2070			



SIZE	Tread pattern	SW mm	OD mm	SLR mm	RC mm	SRI	Rim	Permitted Rims	Type	Tube
<b>480/65R24</b> 133D	<b>TM800</b>	479	1234	563	3670	600	DW15L	W14L - W15L - W16L(°) DW14L - DW15L - DW16L(°)	TUBELESS	16.9-24 TR218

**PRESSURE**

**H**

psi	<b>9</b>	<b>12</b>	<b>14</b>	<b>17</b>	<b>20</b>	<b>23</b>	<b>26</b>	<b>28</b>	<b>30</b>
bar	<b>0,6</b>	<b>0,8</b>	<b>1,0</b>	<b>1,2</b>	<b>1,4</b>	<b>1,6</b>	<b>1,8</b>	<b>1,9</b>	<b>2,1</b>

**MAX. LOAD kg**

<b>65 S</b>	1195	1385	1570	1735	1900	<b>2060</b>			
50 S	1255	1450	1645	1820	1990	2165			
40 S	1310	1515	1715	1895	2080	2260			
30 S	1375	1590	1805	1990	2180	2370			
10 LT S	1625	1880	2130	2355	2580	2805	2995	3090	3505
10 HT S	1375	1590	1805	1990	2180	2370			

SIZE	Tread pattern	SW mm	OD mm	SLR mm	RC mm	SRI	Rim	Permitted Rims	Type	Tube
<b>540/65R24</b> 140D	<b>TM800</b>	530	1312	595	3940	625	DW16L	W16L - W15L(°) - W18L DW15L(°)	TUBELESS	16.9-24 TR218

**PRESSURE**

**H**

psi	<b>9</b>	<b>12</b>	<b>14</b>	<b>17</b>	<b>20</b>	<b>23</b>	<b>26</b>	<b>28</b>	<b>30</b>
bar	<b>0,6</b>	<b>0,8</b>	<b>1,0</b>	<b>1,2</b>	<b>1,4</b>	<b>1,6</b>	<b>1,8</b>	<b>1,9</b>	<b>2,1</b>

**MAX. LOAD kg**

<b>65 S</b>	1450	1675	1900	2100	2300	<b>2500</b>			
50 S	1525	1760	1995	2205	2415	2625			
40 S	1590	1835	2085	2300	2520	2740			
30 S	1670	1930	2185	2415	2645	2875			
10 LT S	1975	2280	2585	2860	3130	3400	3635	3750	4250
10 HT S	1670	1930	2185	2415	2645	2875			

SIZE	Tread pattern	SW mm	OD mm	SLR mm	RC mm	SRI	Rim	Permitted Rims	Type	Tube
<b>540/65R24</b> 146A8	<b>TM800</b>	535	1312	595	3940	625	DW16L	W16L - W15L(°) W18L - DW15L(°)	TUBELESS	16.9-24 TR218

**PRESSURE**

**H**

psi	<b>12</b>	<b>14</b>	<b>17</b>	<b>20</b>	<b>23</b>	<b>29</b>	<b>35</b>	<b>38</b>	<b>41</b>
bar	<b>0,8</b>	<b>1,0</b>	<b>1,2</b>	<b>1,4</b>	<b>1,6</b>	<b>2,0</b>	<b>2,4</b>	<b>2,6</b>	<b>2,8</b>

**MAX. LOAD kg**

<b>40 S</b>	1650	1890	2100	2310	2490	2760	<b>3000</b>		
30 S	1770	2025	2250	2475	2665	2955	3210		
10 LT S	2245	2575	2860	3145	3390	3755	4080	4285	4500
10 HT S	1770	2025	2250	2475	2665	2955	3210		
10 Cyc S	2495	2855	3175	3490	3760	4170	4530	4825	5100

For harvesting applications

**TM800**

Radial tire for tractors and harvesters



SIZE	Tread pattern	SW mm	OD mm	SLR mm	RC mm	SRI	Rim	Permitted Rims	Type	Tube	
540/65R26 141D	TM800	540	1365	615	4060	650	DW16L	W15L(°) - W16L W18L - DW18L DW15L(°)	TUBELESS	16.9-26 TR218	
<b>PRESSURE</b>										<b>H</b>	
psi			<b>9</b>	<b>12</b>	<b>14</b>	<b>17</b>	<b>20</b>	<b>23</b>	<b>26</b>	<b>28</b>	<b>30</b>
bar			<b>0,6</b>	<b>0,8</b>	<b>1,0</b>	<b>1,2</b>	<b>1,4</b>	<b>1,6</b>	<b>1,8</b>	<b>1,9</b>	<b>2,1</b>
<b>MAX. LOAD kg</b>											
<b>65 S</b>			1495	1730	1960	2165	2370	<b>2575</b>			
50 S			1570	1815	2055	2275	2490	2705			
40 S			1640	1890	2145	2370	2595	2820			
30 S			1720	1985	2255	2490	2725	2965			
10 LT S			2035	2350	2665	2945	3225	3505	3745	3865	4380
10 HT S			1720	1985	2255	2490	2725	2965			

SIZE	Tread pattern	SW mm	OD mm	SLR mm	RC mm	SRI	Rim	Permitted Rims	Type	Tube	
440/65R28 131D	TM800	441	1283	583	3905	625	W14L	W13L	TUBELESS	16.9-28 TR218	
<b>PRESSURE</b>										<b>H</b>	
psi			<b>9</b>	<b>12</b>	<b>14</b>	<b>17</b>	<b>20</b>	<b>23</b>	<b>26</b>	<b>28</b>	<b>30</b>
bar			<b>0,6</b>	<b>0,8</b>	<b>1,0</b>	<b>1,2</b>	<b>1,4</b>	<b>1,6</b>	<b>1,8</b>	<b>1,9</b>	<b>2,1</b>
<b>MAX. LOAD kg</b>											
<b>65 S</b>			1135	1310	1485	1640	1795	<b>1950</b>			
50 S			1190	1375	1560	1720	1885	2050			
40 S			1240	1435	1625	1795	1965	2140			
30 S			1305	1505	1705	1885	2065	2245			
10 LT S			1540	1780	2020	2230	2440	2655	2835	2925	3315
10 HT S			1305	1505	1705	1885	2065	2245			

SIZE	Tread pattern	SW mm	OD mm	SLR mm	RC mm	SRI	Rim	Permitted Rims	Type	Tube	
480/65R28 136D	TM800	479	1335	605	4025	650	DW15L	W14L - W15L - W16L(°) DW14L - DW16L(°)	TUBELESS	16.9-28 TR218	
<b>PRESSURE</b>										<b>H</b>	
psi			<b>9</b>	<b>12</b>	<b>14</b>	<b>17</b>	<b>20</b>	<b>23</b>	<b>26</b>	<b>28</b>	<b>30</b>
bar			<b>0,6</b>	<b>0,8</b>	<b>1,0</b>	<b>1,2</b>	<b>1,4</b>	<b>1,6</b>	<b>1,8</b>	<b>1,9</b>	<b>2,1</b>
<b>MAX. LOAD kg</b>											
<b>65 S</b>			1300	1505	1705	1885	2065	<b>2240</b>			
50 S			1365	1580	1790	1980	2165	2355			
40 S			1425	1645	1865	2065	2260	2455			
30 S			1495	1730	1960	2165	2370	2580			
10 LT S			1770	2045	2320	2560	2805	3050	3260	3360	3810
10 HT S			1495	1730	1960	2165	2370	2580			

SIZE	Tread pattern	SW mm	OD mm	SLR mm	RC mm	SRI	Rim	Permitted Rims	Type	Tube
540/65R28 142D	TM800	530	1413	637	4240	675	DW16L	W15L(°) - W16L - W18L DW15L(°) - DW18L	TUBELESS	16.9-28 TR218

**PRESSURE**

**H**

psi	<b>9</b>	<b>12</b>	<b>14</b>	<b>17</b>	<b>20</b>	<b>23</b>	<b>26</b>	<b>28</b>	<b>30</b>
bar	<b>0,6</b>	<b>0,8</b>	<b>1,0</b>	<b>1,2</b>	<b>1,4</b>	<b>1,6</b>	<b>1,8</b>	<b>1,9</b>	<b>2,1</b>

**MAX. LOAD kg**

<b>65 S</b>	1540	1780	2015	2230	2440	<b>2650</b>			
50 S	1615	1865	2115	2340	2560	2785			
40 S	1685	1945	2210	2440	2670	2905			
30 S	1770	2045	2320	2560	2805	3050			
10 LT S	2095	2415	2740	3030	3320	3605	3855	3975	4505
10 HT S	1770	2045	2320	2560	2805	3050			

SIZE	Tread pattern	SW mm	OD mm	SLR mm	RC mm	SRI	Rim	Permitted Rims	Type	Tube
540/65R28 142D	TM800 ProgressiveTraction®	525	1425	630	4240	675	DW16L	W15L(°) - W16L - W18L DW15L(°) - DW18L	TUBELESS	16.9-28 TR218

**PRESSURE**

**H**

psi	<b>9</b>	<b>12</b>	<b>14</b>	<b>17</b>	<b>20</b>	<b>23</b>	<b>26</b>	<b>28</b>	<b>30</b>
bar	<b>0,6</b>	<b>0,8</b>	<b>1,0</b>	<b>1,2</b>	<b>1,4</b>	<b>1,6</b>	<b>1,8</b>	<b>1,9</b>	<b>2,1</b>

**MAX. LOAD kg**

<b>65 S</b>	1540	1780	2015	2230	2440	<b>2650</b>			
50 S	1615	1865	2115	2340	2560	2785			
40 S	1685	1945	2210	2440	2670	2905			
30 S	1770	2045	2320	2560	2805	3050			
10 LT S	2095	2415	2740	3030	3320	3605	3855	3975	4505
10 HT S	1770	2045	2320	2560	2805	3050			

SIZE	Tread pattern	SW mm	OD mm	SLR mm	RC mm	SRI	Rim	Permitted Rims	Type	Tube
600/65R28 147D	TM800	590	1491	660	4447	700	DW18L	W18L - DW20B	TUBELESS	16.9-28 TR218

**PRESSURE**

**H**

psi	<b>9</b>	<b>12</b>	<b>14</b>	<b>17</b>	<b>20</b>	<b>23</b>	<b>26</b>	<b>28</b>	<b>30</b>
bar	<b>0,6</b>	<b>0,8</b>	<b>1,0</b>	<b>1,2</b>	<b>1,4</b>	<b>1,6</b>	<b>1,8</b>	<b>1,9</b>	<b>2,1</b>

**MAX. LOAD kg**

<b>65 S</b>	1790	2065	2345	2590	2835	<b>3075</b>			
50 S	1880	2170	2460	2720	2980	3235			
40 S	1960	2260	2565	2835	3105	3375			
30 S	2055	2375	2695	2980	3260	3545			
10 LT S	2430	2810	3185	3520	3855	4190	4480	4620	5240
10 HT S	2055	2375	2695	2980	3260	3545			

**TM800**

Radial tire for tractors and harvesters



SIZE	Tread pattern	SW mm	OD mm	SLR mm	RC mm	SRI	Rim	Permitted Rims	Type	Tube
<b>540/65R30</b> 143D	<b>TM800</b>	530	1464	665	4400	700	DW16L	W15L(°) - W16L - W18L DW15L(°) - DW18L	TUBELESS	18.4-30 TR218

**PRESSURE**

**H**

<b>psi</b>	<b>9</b>	<b>12</b>	<b>14</b>	<b>17</b>	<b>20</b>	<b>23</b>	<b>26</b>	<b>28</b>	<b>30</b>
<b>bar</b>	<b>0,6</b>	<b>0,8</b>	<b>1,0</b>	<b>1,2</b>	<b>1,4</b>	<b>1,6</b>	<b>1,8</b>	<b>1,9</b>	<b>2,1</b>

**MAX. LOAD kg**

<b>65 S</b>	1585	1830	2075	2290	2510	<b>2725</b>				
50 S	1660	1920	2175	2405	2635	2865				
40 S	1735	2000	2270	2510	2750	2985				
30 S	1820	2100	2385	2635	2885	3135				
10 LT S	2150	2485	2820	3115	3410	3710	3965	4090	4635	
10 HT S	1820	2100	2385	2635	2885	3135				

SIZE	Tread pattern	SW mm	OD mm	SLR mm	RC mm	SRI	Rim	Permitted Rims	Type	Tube
<b>540/65R34</b> 145D	<b>TM800</b>	530	1566	710	4710	750	DW16L	W15L(°) - W16L - W18L DW15L(°) - DW18L	TUBELESS	16.9-34 TR218

**PRESSURE**

**H**

<b>psi</b>	<b>9</b>	<b>12</b>	<b>14</b>	<b>17</b>	<b>20</b>	<b>23</b>	<b>26</b>	<b>28</b>	<b>30</b>
<b>bar</b>	<b>0,6</b>	<b>0,8</b>	<b>1,0</b>	<b>1,2</b>	<b>1,4</b>	<b>1,6</b>	<b>1,8</b>	<b>1,9</b>	<b>2,1</b>

**MAX. LOAD kg**

<b>65 S</b>	1685	1945	2205	2440	2670	<b>2900</b>				
50 S	1770	2045	2315	2560	2805	3045				
40 S	1845	2130	2415	2670	2925	3180				
30 S	1935	2235	2535	2805	3070	3335				
10 LT S	2290	2645	3000	3315	3630	3945	4220	4350	4930	
10 HT S	1935	2235	2535	2805	3070	3335				

SIZE	Tread pattern	SW mm	OD mm	SLR mm	RC mm	SRI	Rim	Permitted Rims	Type	Tube
<b>600/65R34</b> 151D	<b>TM800</b>	600	1644	740	4920	775	DW20B	DW18L - W18L	TUBELESS	

**PRESSURE**

**H**

<b>psi</b>	<b>9</b>	<b>12</b>	<b>14</b>	<b>17</b>	<b>20</b>	<b>23</b>	<b>26</b>	<b>28</b>	<b>30</b>
<b>bar</b>	<b>0,6</b>	<b>0,8</b>	<b>1,0</b>	<b>1,2</b>	<b>1,4</b>	<b>1,6</b>	<b>1,8</b>	<b>1,9</b>	<b>2,1</b>

**MAX. LOAD kg**

<b>65 S</b>	2005	2315	2625	2900	3175	<b>3450</b>				
50 S	2105	2430	2755	3045	3335	3625				
40 S	2195	2535	2875	3175	3480	3780				
30 S	2305	2660	3020	3335	3655	3970				
10 LT S	2725	3145	3570	3945	4320	4695	5020	5175	5865	
10 HT S	2305	2660	3020	3335	3655	3970				

SIZE	Tread pattern	SW mm	OD mm	SLR mm	RC mm	SRI	Rim	Permitted Rims	Type	Tube
<b>540/65R38</b> 147D	<b>TM800</b>	530	1667	760	5010	800	DW16L	W15L(°) - W16L - W18L DW15L(°) - DW18L	TUBELESS	18.4-38 TR218

**PRESSURE**

**H**

<b>psi</b>	<b>9</b>	<b>12</b>	<b>14</b>	<b>17</b>	<b>20</b>	<b>23</b>	<b>26</b>	<b>28</b>	<b>30</b>
<b>bar</b>	<b>0,6</b>	<b>0,8</b>	<b>1,0</b>	<b>1,2</b>	<b>1,4</b>	<b>1,6</b>	<b>1,8</b>	<b>1,9</b>	<b>2,1</b>

**MAX. LOAD kg**

<b>65 S</b>	1790	2065	2345	2590	2835	<b>3080</b>			
50 S	1880	2170	2460	2720	2980	3235			
40 S	1960	2260	2565	2835	3105	3375			
30 S	2055	2375	2695	2980	3260	3545			
10 LT S	2430	2810	3185	3520	3855	4190	4480	4620	5240
10 HT S	2055	2375	2695	2980	3260	3545			

SIZE	Tread pattern	SW mm	OD mm	SLR mm	RC mm	SRI	Rim	Permitted Rims	Type	Tube
<b>600/65R38</b> 153D	<b>TM800</b>	590	1745	785	5210	825	DW18L	W18L - DW20B	TUBELESS	20.8-38 TR218

**PRESSURE**

**H**

<b>psi</b>	<b>9</b>	<b>12</b>	<b>14</b>	<b>17</b>	<b>20</b>	<b>23</b>	<b>26</b>	<b>28</b>	<b>30</b>
<b>bar</b>	<b>0,6</b>	<b>0,8</b>	<b>1,0</b>	<b>1,2</b>	<b>1,4</b>	<b>1,6</b>	<b>1,8</b>	<b>1,9</b>	<b>2,1</b>

**MAX. LOAD kg**

<b>65 S</b>	2125	2455	2785	3075	3370	<b>3660</b>			
50 S	2230	2575	2925	3230	3540	3845			
40 S	2325	2690	3050	3370	3690	4010			
30 S	2445	2825	3200	3540	3875	4210			
10 LT S	2890	3335	3785	4185	4580	4980	5325	5490	6225
10 HT S	2445	2825	3200	3540	3875	4210			

SIZE	Tread pattern	SW mm	OD mm	SLR mm	RC mm	SRI	Rim	Permitted Rims	Type	Tube
<b>650/65R38</b> 157D	<b>TM800</b>	645	1811	815	5395	875	DW20B	W18L(°) - DW18L(°)	TUBELESS	20.8-38 TR218

**PRESSURE**

**H**

<b>psi</b>	<b>9</b>	<b>12</b>	<b>14</b>	<b>17</b>	<b>20</b>	<b>23</b>	<b>26</b>	<b>28</b>	<b>30</b>
<b>bar</b>	<b>0,6</b>	<b>0,8</b>	<b>1,0</b>	<b>1,2</b>	<b>1,4</b>	<b>1,6</b>	<b>1,8</b>	<b>1,9</b>	<b>2,1</b>

**MAX. LOAD kg**

<b>65 S</b>	2395	2765	3135	3465	3795	<b>4125</b>			
50 S	2515	2905	3295	3640	3985	4335			
40 S	2620	3030	3435	3795	4160	4520			
30 S	2755	3180	3610	3985	4365	4745			
10 LT S	3255	3760	4265	4715	5165	5610	6000	6190	7015
10 HT S	2755	3180	3610	3985	4365	4745			

**TM800**

Radial tire for tractors and harvesters



SIZE	Tread pattern	SW mm	OD mm	SLR mm	RC mm	SRI	Rim	Permitted Rims	Type	Tube
650/65R38 157D	TM800 ProgressiveTraction®	650	1820	810	5395	875	DW20B	W18L(°) - DW18L(°)	TUBELESS	20.8-38 TR218
<b>PRESSURE</b>										<b>H</b>
psi		<b>9</b>	<b>12</b>	<b>14</b>	<b>17</b>	<b>20</b>	<b>23</b>	<b>26</b>	<b>28</b>	<b>30</b>
bar		<b>0,6</b>	<b>0,8</b>	<b>1,0</b>	<b>1,2</b>	<b>1,4</b>	<b>1,6</b>	<b>1,8</b>	<b>1,9</b>	<b>2,1</b>
<b>MAX. LOAD kg</b>										
<b>65 S</b>		2395	2765	3135	3465	3795	<b>4125</b>			
50 S		2515	2905	3295	3640	3985	4335			
40 S		2620	3030	3435	3795	4160	4520			
30 S		2755	3180	3610	3985	4365	4745			
10 LT S		3255	3760	4265	4715	5165	5610	6000	6190	7015
10 HT S		2755	3180	3610	3985	4365	4745			

SIZE	Tread pattern	SW mm	OD mm	SLR mm	RC mm	SRI	Rim	Permitted Rims	Type	Tube
710/70R38 166D	TM800	716	1959	884	5765	925	DW23B		TUBELESS	
<b>PRESSURE</b>										<b>H</b>
psi		<b>9</b>	<b>12</b>	<b>14</b>	<b>17</b>	<b>20</b>	<b>23</b>	<b>26</b>	<b>28</b>	<b>30</b>
bar		<b>0,6</b>	<b>0,8</b>	<b>1,0</b>	<b>1,2</b>	<b>1,4</b>	<b>1,6</b>	<b>1,8</b>	<b>1,9</b>	<b>2,1</b>
<b>MAX. LOAD kg</b>										
<b>65 S</b>		3075	3555	4030	4455	4880	<b>5300</b>			
50 S		3230	3730	4230	4675	5120	5565			
40 S		3370	3890	4415	4875	5340	5805			
30 S		3540	4085	4635	5120	5610	6095			
10 LT S		4185	4830	5480	6055	6635	7210	7710	7950	9010
10 HT S		3540	4085	4635	5120	5610	6095			

SIZE	Tread pattern	SW mm	OD mm	SLR mm	RC mm	SRI	Rim	Permitted Rims	Type	Tube
710/70R38 166D	TM800 Sugar Cane	716	1959	884	5765	925	DW23B		TUBELESS	

**PRESSURE**

**H**

psi	<b>9</b>	<b>12</b>	<b>14</b>	<b>17</b>	<b>20</b>	<b>23</b>	<b>26</b>	<b>28</b>	<b>30</b>
bar	<b>0,6</b>	<b>0,8</b>	<b>1,0</b>	<b>1,2</b>	<b>1,4</b>	<b>1,6</b>	<b>1,8</b>	<b>1,9</b>	<b>2,1</b>

**MAX. LOAD kg**

<b>65 S</b>	3075	3555	4030	4455	4880	<b>5300</b>			
50 S	3230	3730	4230	4675	5120	5565			
40 S	3370	3890	4415	4875	5340	5805			
30 S	3540	4085	4635	5120	5610	6095			
10 LT S	4185	4830	5480	6055	6635	7210	7710	7950	9010
10 HT S	3540	4085	4635	5120	5610	6095			

SIZE	Tread pattern	SW mm	OD mm	SLR mm	RC mm	SRI	Rim	Permitted Rims	Type	Tube
710/70R38 171D	TM800 Sugar Cane	716	1935	884	5805	925	DW23B		TUBELESS	

**PRESSURE**

**H**

psi	<b>9</b>	<b>12</b>	<b>15</b>	<b>17</b>	<b>20</b>	<b>23</b>	<b>29</b>	<b>35</b>
bar	<b>0,6</b>	<b>0,8</b>	<b>1,0</b>	<b>1,2</b>	<b>1,4</b>	<b>1,6</b>	<b>2,0</b>	<b>2,4</b>

**MAX. LOAD kg**

<b>65 S</b>							5300	5780	<b>6150</b>
50 S	3035	3485	4005	4520	5035	5600	6070	6500	
40 S	3165	3635	4175	4715	5255	5800	6330	6700	
30 S	3325	3820	4385	4950	5515	6150	6650	7100	
10 LT S	4335	4980	5720	6460	7195	8000	8670	9225	
10 HT S	3325	3820	4385	4950	5515	6150	6650	7100	

**TM800**

Radial tire for tractors and harvesters



SIZE	Tread pattern	SW mm	OD mm	SLR mm	RC mm	SRI	Rim	Permitted Rims	Type	Tube
710/70R38 175D	TM800 Forage	715	1960	884	5885	925	DW23B		TUBELESS	

**PRESSURE**

psi	<b>12</b>	<b>14</b>	<b>17</b>	<b>20</b>	<b>23</b>	<b>29</b>	<b>35</b>	<b>41</b>	<b>46</b>	<b>49</b>
bar	<b>0,8</b>	<b>1,0</b>	<b>1,2</b>	<b>1,4</b>	<b>1,6</b>	<b>2,0</b>	<b>2,4</b>	<b>2,8</b>	<b>3,2</b>	<b>3,4</b>

**MAX. LOAD kg**

<b>65 S</b>	3450	3935	4420	4900	5385	5935	6280	<b>6900</b>		
50 S	3625	4135	4645	5145	5655	6235	6595	7245		
40 S	3780	4310	4840	5370	5900	6500	6880	7560		
30 S	3970	4530	5085	5635	6195	6830	7225	7935		
10 LT S	4275	4875	5640	6395	7125	8310	8830	9705	9940	10350
10 HT S	3970	4530	5085	5635	6195	6830	7225	7935		
10 Cyc S		5710	6545	7350	8510	9465	10015	11040	11300	11730

SIZE	Tread pattern	SW mm	OD mm	SLR mm	RC mm	SRI	Rim	Permitted Rims	Type	Tube
600/65R42 154D	TM800	590	1847	830	5580	875	DW18L	W18L - DW20B	TUBELESS	20.8-42 TR218

**PRESSURE**

**H**

psi	<b>9</b>	<b>12</b>	<b>14</b>	<b>17</b>	<b>20</b>	<b>23</b>	<b>26</b>	<b>28</b>	<b>30</b>
bar	<b>0,6</b>	<b>0,8</b>	<b>1,0</b>	<b>1,2</b>	<b>1,4</b>	<b>1,6</b>	<b>1,8</b>	<b>1,9</b>	<b>2,1</b>

**MAX. LOAD kg**

<b>65 S</b>	2175	2515	2850	3150	3450	<b>3750</b>				
50 S	2285	2640	2995	3310	3625	3940				
40 S	2385	2755	3125	3450	3780	4110				
30 S	2505	2890	3280	3625	3970	4315				
10 LT S	2960	3420	3880	4285	4695	5100	5455	5625	6375	
10 HT S	2505	2890	3280	3625	3970	4315				



SIZE	Tread pattern	SW mm	OD mm	SLR mm	RC mm	SRI	Rim	Permitted Rims	Type	Tube	
<b>650/65R42</b> 158D	<b>TM800</b>	645	1913	860	5780	925	DW20B	W18L(°) - DW18L(°)	TUBELESS	20.8-42 TR218	
<b>PRESSURE</b>										<b>H</b>	
psi			<b>9</b>	<b>12</b>	<b>14</b>	<b>17</b>	<b>20</b>	<b>23</b>	<b>26</b>	<b>28</b>	<b>30</b>
bar			<b>0,6</b>	<b>0,8</b>	<b>1,0</b>	<b>1,2</b>	<b>1,4</b>	<b>1,6</b>	<b>1,8</b>	<b>1,9</b>	<b>2,1</b>
<b>MAX. LOAD kg</b>											
<b>65 S</b>			2465	2850	3230	3570	3910	<b>4250</b>			
50 S			2590	2990	3395	3750	4110	4465			
40 S			2700	3120	3540	3910	4285	4655			
30 S			2835	3275	3715	4110	4500	4890			
10 LT S			3355	3875	4395	4860	5320	5780	6180	6375	7225
10 HT S			2835	3275	3715	4110	4500	4890			

SIZE	Tread pattern	SW mm	OD mm	SLR mm	RC mm	SRI	Rim	Permitted Rims	Type	Tube
<b>650/65R42</b> 165D (168A8)	<b>TM800</b>	645	1927	875	5815	925	DW20B	DW18L	TUBELESS	20.8-42 TR218
<b>PRESSURE</b>										
psi			<b>9</b>	<b>12</b>	<b>14</b>	<b>17</b>	<b>20</b>	<b>23</b>	<b>29</b>	<b>35</b>
bar			<b>0,6</b>	<b>0,8</b>	<b>1,0</b>	<b>1,2</b>	<b>1,4</b>	<b>1,6</b>	<b>2,0</b>	<b>2,4</b>
<b>MAX. LOAD kg</b>										
<b>65 S</b>								4275	4790	<b>5150</b>
50 S			2580	3015	3450	3830	4220	4545	5090	5470
40 S			2660	3110	3560	3955	4355	4690	5250	5645
30 S			2825	3300	3780	4200	4625	4980	5580	5995
10 LT S			3275	3830	4385	4870	5360	5775	6470	6955
10 HT S			2825	3300	3780	4200	4625	4980	5580	5995

For technical notes about pressure tables please refer to page 260.

## TM800

Radial tire for tractors and harvesters



# TM800 HIGH SPEED



The TM800 High Speed has been developed to extend the well-known road performance of TM800, utilising the High Speed technology to generate the most advanced radial tire for agricultural applications.

TM800 High Speed handling, grip, comfort and safety reach excellent levels and match perfectly with the

technological evolution of modern agricultural tractors.

SIZE		
540/65R28	149D	(146E)
600/65R28	154D	(151E)
540/65R30	150D	(147E)
540/65R34	152D	(149E)
600/65R34	157D	(154E)

SIZE		
540/65R38	153D	(150E)
650/65R38	163D	(159E)
650/65R38	166D	(169A8)
710/70R38	171D	(168E)

SIZE	Tread pattern	SW mm	OD mm	SLR mm	RC mm	SRI	Rim	Permitted Rims	Type	Tube
540/65R28 149D (146E)	TM800 HS	530	1413	637	4220	675	DW16L	W15L(°) - W16L - W18L DW15L(°) - DW18L	TUBELESS	16.9-28 TR218

## PRESSURE

psi	6	9	12	17	23	26	29	32	35
bar	0,4	0,6	0,8	1,2	1,6	1,8	2,0	2,2	2,4

## MAX. LOAD kg

70 S						2415	2560	2710	2855	3000
<b>65 S</b>						2650	2800	2950	3100	<b>3250</b>
50 S			1710	1890	2355	2785	2940	3100	3255	3415
40 S			1785	1975	2455	2905	3070	3235	3395	3560
30 S			1875	2070	2580	3050	3220	3395	3565	3740
10 LT S	2190	2445	2700	3360	3975	4200	4425	4650	4875	
10 HT S			1875	2070	2580	3050	3220	3395	3565	3740

SIZE	Tread pattern	SW mm	OD mm	SLR mm	RC mm	SRI	Rim	Permitted Rims	Type	Tube	
<b>600/65R28</b> 154D (151E)	<b>TM800 HS</b>	590	1491	660	4490	700	DW18L	W18L - DW20B	TUBELESS	16.9-28 TR218	
<b>PRESSURE</b>											
psi			<b>6</b>	<b>9</b>	<b>12</b>	<b>17</b>	<b>23</b>	<b>26</b>	<b>29</b>	<b>32</b>	<b>35</b>
bar			<b>0,4</b>	<b>0,6</b>	<b>0,8</b>	<b>1,2</b>	<b>1,6</b>	<b>1,8</b>	<b>2,0</b>	<b>2,2</b>	<b>2,4</b>
<b>MAX. LOAD kg</b>											
70 S							2870	3015	3160	3305	3450
<b>65 S</b>							3150	3300	3450	3600	<b>3750</b>
50 S				2015	2230	2785	3310	3465	3625	3780	3940
40 S				2105	2325	2905	3450	3615	3780	3945	4110
30 S				2210	2440	3050	3625	3795	3970	4140	4315
10 LT S			2575	2880	3180	3975	4725	4950	5175	5400	5625
10 HT S			2210	2440	3050	3625	3795	3970	4140	4315	

SIZE	Tread pattern	SW mm	OD mm	SLR mm	RC mm	SRI	Rim	Permitted Rims	Type	Tube	
<b>540/65R30</b> 150D (147E)	<b>TM800 HS</b>	530	1464	665	4445	700	DW16L	W15L(°) - W16L - W18L DW15L(°) - DW18L	TUBELESS	18.4-30 TR218	
<b>PRESSURE</b>											
psi			<b>6</b>	<b>9</b>	<b>12</b>	<b>17</b>	<b>23</b>	<b>26</b>	<b>29</b>	<b>32</b>	<b>35</b>
bar			<b>0,4</b>	<b>0,6</b>	<b>0,8</b>	<b>1,2</b>	<b>1,6</b>	<b>1,8</b>	<b>2,0</b>	<b>2,2</b>	<b>2,4</b>
<b>MAX. LOAD kg</b>											
70 S							2480	2630	2780	2930	3075
<b>65 S</b>							2725	2885	3040	3195	<b>3350</b>
50 S				1760	1945	2480	2865	3030	3190	3355	3520
40 S				1835	2030	2585	2985	3155	3330	3500	3670
30 S				1925	2130	2715	3135	3315	3495	3675	3855
10 LT S			2250	2515	2775	3540	4090	4325	4560	4795	5025
10 HT S			1925	2130	2715	3135	3315	3495	3675	3855	

SIZE	Tread pattern	SW mm	OD mm	SLR mm	RC mm	SRI	Rim	Permitted Rims	Type	Tube	
<b>540/65R34</b> 152D (149E)	<b>TM800 HS</b>	530	1566	710	4710	750	DW16L	W15L(°) - W16L - W18L DW15L(°) - DW18L	TUBELESS	16.9-34 TR218	
<b>PRESSURE</b>											
psi			<b>6</b>	<b>9</b>	<b>12</b>	<b>17</b>	<b>23</b>	<b>26</b>	<b>29</b>	<b>32</b>	<b>35</b>
bar			<b>0,4</b>	<b>0,6</b>	<b>0,8</b>	<b>1,2</b>	<b>1,6</b>	<b>1,8</b>	<b>2,0</b>	<b>2,2</b>	<b>2,4</b>
<b>MAX. LOAD kg</b>											
70 S							2640	2795	2945	3100	3250
<b>65 S</b>							2900	3065	3225	3390	<b>3550</b>
50 S				1900	2100	2625	3045	3220	3390	3560	3730
40 S				1985	2190	2740	3180	3355	3535	3710	3890
30 S				2085	2300	2875	3335	3525	3710	3900	4085
10 LT S			2430	2715	3000	3750	4350	4595	4840	5085	5325
10 HT S			2085	2300	2875	3335	3525	3710	3900	4085	

### TM800 HIGH SPEED

Radial tire for tractors and harvesters



SIZE	Tread pattern	SW mm	OD mm	SLR mm	RC mm	SRI	Rim	Permitted Rims	Type	Tube
<b>600/65R34</b> 157D (154E)	<b>TM800 HS</b>	600	1660	745	4965	775	DW20B	DW18L - W18L	TUBELESS	
<b>PRESSURE</b>										
<b>psi</b>			<b>9</b>	<b>12</b>	<b>14</b>	<b>17</b>	<b>20</b>	<b>23</b>	<b>29</b>	<b>35</b>
<b>bar</b>			<b>0,6</b>	<b>0,8</b>	<b>1,0</b>	<b>1,2</b>	<b>1,4</b>	<b>1,6</b>	<b>2,0</b>	<b>2,4</b>
<b>MAX. LOAD kg</b>										
70S								3115	3450	3750
<b>65S</b>								3425	3795	<b>4125</b>
50 S			2080	2430	2730	3035	3340	3595	3985	4335
40 S			2170	2530	2850	3165	3480	3750	4160	4520
30 S			2280	2660	2990	3325	3655	3940	4365	4745
10 LT S			2970	3465	3900	4335	4765	5140	5695	6190
10 HT S			2280	2660	2990	3325	3655	3940	4365	4745

SIZE	Tread pattern	SW mm	OD mm	SLR mm	RC mm	SRI	Rim	Permitted Rims	Type	Tube
<b>540/65R38</b> 153D (150E)	<b>TM800 HS</b>	516	1709	760	5181	800	DW16L	W15L(°) - W16L - W18L DW15L(°) - DW18L	TUBELESS	18.4-38 TR218
<b>PRESSURE</b>										
<b>psi</b>			<b>9</b>	<b>12</b>	<b>14</b>	<b>17</b>	<b>20</b>	<b>23</b>	<b>29</b>	<b>35</b>
<b>bar</b>			<b>0,6</b>	<b>0,8</b>	<b>1,0</b>	<b>1,2</b>	<b>1,4</b>	<b>1,6</b>	<b>2,0</b>	<b>2,4</b>
<b>MAX. LOAD kg</b>										
70 S								2725	3090	3350
<b>65 S</b>								3000	3395	<b>3650</b>
50 S			1800	2110	2415	2685	2950	3150	3565	3875
40 S			1880	2200	2520	2800	3075	3315	3715	4000
30 S			1975	2310	2645	2940	3230	3450	3905	4250
10 LT S			2575	3010	3450	3835	4215	4500	5090	5450
10 HT S			1975	2310	2645	2940	3230	3450	3905	4250

SIZE	Tread pattern	SW mm	OD mm	SLR mm	RC mm	SRI	Rim	Permitted Rims	Type	Tube
<b>650/65R38</b> 163D (159E)	<b>TM800 HS</b>	645	1811	815	5450	875	DW20B	W18L(°) - DW18L(°)	TUBELESS	20.8-38 TR218
<b>PRESSURE</b>										
<b>psi</b>			<b>6</b>	<b>9</b>	<b>12</b>	<b>17</b>	<b>23</b>	<b>26</b>	<b>29</b>	<b>32</b>
<b>bar</b>			<b>0,4</b>	<b>0,6</b>	<b>0,8</b>	<b>1,2</b>	<b>1,6</b>	<b>1,8</b>	<b>2,0</b>	<b>2,2</b>
<b>MAX. LOAD kg</b>										
70 S							3755	3910	4065	4220
<b>65 S</b>							4125	4315	4500	<b>4620</b>
50 S				2660	2940	3625	4335	4530	4725	4925
40 S				2775	3070	3780	4520	4725	4930	5135
30 S				2915	3220	3970	4745	4960	5175	5395
10 LT S			3400	3800	4200	5175	6190	6470	6750	7035
10 HT S				2915	3220	3970	4745	4960	5175	5395

SIZE	Tread pattern	SW mm	OD mm	SLR mm	RC mm	SRI	Rim	Permitted Rims	Type	Tube	
<b>650/65R38</b> 166D (169A8)	<b>TM800 HS</b>	657	1818	823	5480	875	DW20B		TUBELESS	20.8-38 TR218	
<b>PRESSURE</b>											
psi			<b>12</b>	<b>14</b>	<b>17</b>	<b>20</b>	<b>23</b>	<b>29</b>	<b>35</b>	<b>41</b>	
bar			<b>0,8</b>	<b>1,0</b>	<b>1,2</b>	<b>1,4</b>	<b>1,6</b>	<b>2,0</b>	<b>2,4</b>	<b>2,8</b>	
<b>MAX. LOAD kg</b>											
<b>65 S</b>								3975	4400	4930	<b>5300</b>
50 S			2650	3100	3550	3945	4225	4675	5240	5630	
40 S			2735	3195	3665	4070	4360	4825	5405	5840	
30 S			2905	3395	3890	4320	4630	5125	5740	6170	
10 LT S			3370	3940	4510	5010	5370	5940	6660	7155	
10 HT S			2905	3395	3890	4320	4630	5125	5740	6170	

SIZE	Tread pattern	SW mm	OD mm	SLR mm	RC mm	SRI	Rim	Permitted Rims	Type	Tube	
<b>710/70R38</b> 171D (168E)	<b>TM800 HS</b>	711	1973	884	5928	925	DW23B		TUBELESS		
<b>PRESSURE</b>											
psi			<b>9</b>	<b>12</b>	<b>14</b>	<b>17</b>	<b>20</b>	<b>23</b>	<b>29</b>	<b>35</b>	
bar			<b>0,6</b>	<b>0,8</b>	<b>1,0</b>	<b>1,2</b>	<b>1,4</b>	<b>1,6</b>	<b>2,0</b>	<b>2,4</b>	
<b>MAX. LOAD kg</b>											
70 S								4875	5260	5600	
<b>65 S</b>								5300	5780	<b>6150</b>	
50 S			3035	3485	4005	4520	5035	5600	6070	6500	
40 S			3165	3635	4175	4715	5255	5800	6330	6700	
30 S			3325	3820	4385	4950	5515	6150	6650	7100	
10 LT S			4335	4980	5720	6460	7195	8000	8670	9225	
10 HT S			3325	3820	4385	4950	5515	6150	6650	7100	

For technical notes about pressure tables please refer to page 260.

## TM800 HIGH SPEED

Radial tire for tractors and harvesters



# TM700 ProgressiveTraction®



The TM700 ProgressiveTraction® is characterised by a special double lug operating on the soil, which releases higher traction when and where it is needed.

Designed according to **BLUE TIRE** technology, the TM700 ProgressiveTraction® increases tire efficiency whilst assuring high productivity.

SIZE	
380/70R28	127D
420/70R28	133D
480/70R28	140D
480/70R30	141D
480/70R34	143A8 (143B)
480/70R34	155A8 (155B)

SIZE	
480/70R38	145D
520/70R38	150D
580/70R38	155D
580/70R42	158D
620/70R42	166D

SIZE	Tread pattern	SW mm	OD mm	SLR mm	RC mm	SRI	Rim	Permitted Rims	Type	Tube
380/70R28 127D	TM700 ProgressiveTraction®	370	1300	585	3880	625	W12	W11 - W13 - DW11 DW12 - DW13	TUBELESS	12.4-28 TR218
<b>PRESSURE</b>										<b>H</b>
<b>psi</b>		<b>9</b>	<b>12</b>	<b>14</b>	<b>17</b>	<b>20</b>	<b>23</b>	<b>26</b>	<b>28</b>	<b>30</b>
<b>bar</b>		<b>0,6</b>	<b>0,8</b>	<b>1,0</b>	<b>1,2</b>	<b>1,4</b>	<b>1,6</b>	<b>1,8</b>	<b>1,9</b>	<b>2,1</b>
<b>MAX. LOAD kg</b>										
<b>65 S</b>		965	1120	1280	1435	1595	<b>1750</b>			
50 S		1015	1180	1345	1510	1675	1840			
40 S		1055	1230	1400	1575	1745	1920			
30 S		1110	1290	1470	1655	1835	2015			
10 LT S		1310	1525	1740	1955	2170	2380	2545	2625	2975
10 HT S		1110	1290	1470	1655	1835	2015			

SIZE	Tread pattern	SW mm	OD mm	SLR mm	RC mm	SRI	Rim	Permitted Rims	Type	Tube	
<b>420/70R28</b> 133D	<b>TM700</b> ProgressiveTraction®	415	1355	610	4070	650	W13	W12-W14L-DW12 DW13-DW14L	TUBELESS	16.9-28 TR218	
<b>PRESSURE</b>										<b>H</b>	
psi			<b>9</b>	<b>12</b>	<b>14</b>	<b>17</b>	<b>20</b>	<b>23</b>	<b>26</b>	<b>28</b>	<b>30</b>
bar			<b>0,6</b>	<b>0,8</b>	<b>1,0</b>	<b>1,2</b>	<b>1,4</b>	<b>1,6</b>	<b>1,8</b>	<b>1,9</b>	<b>2,1</b>
<b>MAX. LOAD kg</b>											
<b>65 S</b>			1135	1320	1505	1690	1875	<b>2060</b>			
50 S			1190	1385	1580	1775	1970	2165			
40 S			1245	1445	1650	1850	2055	2260			
30 S			1305	1520	1730	1945	2160	2370			
10 LT S			1545	1795	2050	2300	2550	2805	2995	3090	3505
10 HT S			1305	1520	1730	1945	2160	2370			

SIZE	Tread pattern	SW mm	OD mm	SLR mm	RC mm	SRI	Rim	Permitted Rims	Type	Tube	
<b>480/70R28</b> 140D	<b>TM700</b> ProgressiveTraction®	480	1430	640	4255	675	W15L	W14L-W16L-DW14L DW15L-DW16L	TUBELESS	16.9-28 TR218	
<b>PRESSURE</b>										<b>H</b>	
psi			<b>9</b>	<b>12</b>	<b>14</b>	<b>17</b>	<b>20</b>	<b>23</b>	<b>26</b>	<b>28</b>	<b>30</b>
bar			<b>0,6</b>	<b>0,8</b>	<b>1,0</b>	<b>1,2</b>	<b>1,4</b>	<b>1,6</b>	<b>1,8</b>	<b>1,9</b>	<b>2,1</b>
<b>MAX. LOAD kg</b>											
<b>65 S</b>			1375	1600	1825	2050	2275	<b>2500</b>			
50 S			1445	1680	1920	2155	2390	2625			
40 S			1510	1755	2000	2245	2495	2740			
30 S			1585	1840	2100	2360	2620	2875			
10 LT S			1870	2180	2485	2790	3095	3400	3635	3750	4250
10 HT S			1585	1840	2100	2360	2620	2875			

SIZE	Tread pattern	SW mm	OD mm	SLR mm	RC mm	SRI	Rim	Permitted Rims	Type	Tube	
<b>480/70R30</b> 141D	<b>TM700</b> ProgressiveTraction®	475	1485	655	4450	700	W15L	W14L - W16L - DW14L DW15L - DW16L	TUBELESS	18.4-30 TR218	
<b>PRESSURE</b>										<b>H</b>	
psi			<b>9</b>	<b>12</b>	<b>14</b>	<b>17</b>	<b>20</b>	<b>23</b>	<b>26</b>	<b>28</b>	<b>30</b>
bar			<b>0,6</b>	<b>0,8</b>	<b>1,0</b>	<b>1,2</b>	<b>1,4</b>	<b>1,6</b>	<b>1,8</b>	<b>1,9</b>	<b>2,1</b>
<b>MAX. LOAD kg</b>											
<b>65 S</b>			1420	1650	1880	2115	2345	<b>2575</b>			
50 S			1490	1735	1975	2220	2465	2705			
40 S			1555	1805	2060	2315	2570	2820			
30 S			1630	1900	2165	2430	2695	2965			
10 LT S			1930	2245	2560	2875	3190	3505	3745	3865	4380
10 HT S			1630	1900	2165	2430	2695	2965			

### TM700 ProgressiveTraction®

Radial tire for tractors



SIZE	Tread pattern	SW mm	OD mm	SLR mm	RC mm	SRI	Rim	Permitted Rims	Type	Tube		
<b>480/70R34</b> 143A8 (143B)	<b>TM700</b> ProgressiveTraction®	475	1585	716	4760	750	W15L	W14L - W16L - DW14L DW15L - DW16L	TUBELESS	16.9-34 TR218		
<b>PRESSURE</b>										<b>H</b>		
psi			<b>6</b>	<b>9</b>	<b>12</b>	<b>14</b>	<b>17</b>	<b>20</b>	<b>23</b>	<b>26</b>	<b>28</b>	<b>30</b>
bar			<b>0,4</b>	<b>0,6</b>	<b>0,8</b>	<b>1,0</b>	<b>1,2</b>	<b>1,4</b>	<b>1,6</b>	<b>1,8</b>	<b>1,9</b>	<b>2,1</b>
<b>MAX. LOAD kg</b>												
50 S				1790	1980	2170	2360	2540	2725			
<b>40 S</b>				1790	1980	2170	2360	2540	<b>2725</b>			
30 S				1920	2120	2320	2520	2720	2920			
10 LT S			2180	2440	2690	2950	3200	3460	3720	3980	4100	4640
10 HT S				1920	2120	2320	2520	2720	2920			

SIZE	Tread pattern	SW mm	OD mm	SLR mm	RC mm	SRI	Rim	Permitted Rims	Type	Tube			
<b>480/70R34</b> 155A8 (155B)	<b>TM700</b> ProgressiveTraction®	475	1580	727	4775	750	W15L	W14L - W16L - DW14L DW15L - DW16L	TUBELESS	16.9-34 TR218			
<b>PRESSURE</b>										<b>H</b>			
psi			<b>12</b>	<b>14</b>	<b>17</b>	<b>20</b>	<b>23</b>	<b>29</b>	<b>35</b>	<b>41</b>	<b>46</b>	<b>49</b>	<b>55</b>
bar			<b>0,8</b>	<b>1,0</b>	<b>1,2</b>	<b>1,4</b>	<b>1,6</b>	<b>2,0</b>	<b>2,4</b>	<b>2,8</b>	<b>3,2</b>	<b>3,4</b>	<b>3,8</b>
<b>MAX. LOAD kg</b>													
50 S			1785	2055	2290	2560	2790	3065	3295	3605	3875		
<b>40 S</b>			1785	2055	2290	2560	2790	3065	3295	3605	<b>3875</b>		
30 S			1910	2200	2455	2740	2990	3280	3530	3860	4150		
10 LT S			2210	2545	2920	3345	3695	4295	4635	5070	5350	5600	5815
10 HT S			1910	2200	2455	2740	2990	3280	3530	3860	4150		

SIZE	Tread pattern	SW mm	OD mm	SLR mm	RC mm	SRI	Rim	Permitted Rims	Type	Tube		
<b>480/70R38</b> 145D	<b>TM700</b> ProgressiveTraction®	490	1690	755	5050	800	W15L	W14L - W16L - DW14L DW15L - DW16L	TUBELESS	18.4-38 TR218		
<b>PRESSURE</b>										<b>H</b>		
psi			<b>9</b>	<b>12</b>	<b>14</b>	<b>17</b>	<b>20</b>	<b>23</b>	<b>26</b>	<b>28</b>	<b>30</b>	
bar			<b>0,6</b>	<b>0,8</b>	<b>1,0</b>	<b>1,2</b>	<b>1,4</b>	<b>1,6</b>	<b>1,8</b>	<b>1,9</b>	<b>2,1</b>	
<b>MAX. LOAD kg</b>												
<b>65 S</b>			1595	1860	2120	2380	2640	<b>2900</b>				
50 S			1675	1950	2225	2500	2775	3045				
40 S			1750	2035	2320	2605	2890	3180				
30 S			1835	2135	2435	2735	3035	3335				
10 LT S			2170	2525	2880	3235	3590	3945	4220	4350	4930	
10 HT S			1835	2135	2435	2735	3035	3335				



SIZE	Tread pattern	SW mm	OD mm	SLR mm	RC mm	SRI	Rim	Permitted Rims	Type	Tube	
<b>520/70R38</b> 150D	<b>TM700</b> ProgressiveTraction®	525	1755	790	5255	825	W16L	W15L-W18L-DW15L DW16L-DW18L	TUBELESS	18.4-38 TR218	
<b>PRESSURE</b>										<b>H</b>	
psi			<b>9</b>	<b>12</b>	<b>14</b>	<b>17</b>	<b>20</b>	<b>23</b>	<b>26</b>	<b>28</b>	<b>30</b>
bar			<b>0,6</b>	<b>0,8</b>	<b>1,0</b>	<b>1,2</b>	<b>1,4</b>	<b>1,6</b>	<b>1,8</b>	<b>1,9</b>	<b>2,1</b>
<b>MAX. LOAD kg</b>											
<b>65 S</b>			1845	2145	2450	2750	3050	<b>3350</b>			
50 S			1935	2255	2570	2885	3205	3520			
40 S			2020	2350	2680	3010	3340	3670			
30 S			2120	2470	2815	3160	3510	3855			
10 LT S			2510	2920	3330	3740	4150	4560	4875	5025	5695
10 HT S			2120	2470	2815	3160	3510	3855			

SIZE	Tread pattern	SW mm	OD mm	SLR mm	RC mm	SRI	Rim	Permitted Rims	Type	Tube	
<b>580/70R38</b> 155D	<b>TM700</b> ProgressiveTraction®	590	1835	820	5455	875	W18L	DW18L	TUBELESS	20.8-38 TR218	
<b>PRESSURE</b>										<b>H</b>	
psi			<b>9</b>	<b>12</b>	<b>14</b>	<b>17</b>	<b>20</b>	<b>23</b>	<b>26</b>	<b>28</b>	<b>30</b>
bar			<b>0,6</b>	<b>0,8</b>	<b>1,0</b>	<b>1,2</b>	<b>1,4</b>	<b>1,6</b>	<b>1,8</b>	<b>1,9</b>	<b>2,1</b>
<b>MAX. LOAD kg</b>											
<b>65 S</b>			2135	2480	2830	3180	3530	<b>3875</b>			
50 S			2240	2605	2975	3340	3705	4070			
40 S			2335	2720	3100	3480	3865	4245			
30 S			2455	2855	3255	3655	4060	4460			
10 LT S			2900	3375	3850	4325	4800	5270	5635	5815	6590
10 HT S			2455	2855	3255	3655	4060	4460			

SIZE	Tread pattern	SW mm	OD mm	SLR mm	RC mm	SRI	Rim	Permitted Rims	Type	Tube	
<b>580/70R42</b> 158D	<b>TM700</b> ProgressiveTraction®	585	1905	850	5695	900	W18L	DW18L	TUBELESS	20.8-42 TR218	
<b>PRESSURE</b>										<b>H</b>	
psi			<b>9</b>	<b>12</b>	<b>14</b>	<b>17</b>	<b>20</b>	<b>23</b>	<b>26</b>	<b>28</b>	<b>30</b>
bar			<b>0,6</b>	<b>0,8</b>	<b>1,0</b>	<b>1,2</b>	<b>1,4</b>	<b>1,6</b>	<b>1,8</b>	<b>1,9</b>	<b>2,1</b>
<b>MAX. LOAD kg</b>											
<b>65 S</b>			2340	2720	3105	3485	3870	<b>4250</b>			
50 S			2455	2860	3260	3660	4065	4465			
40 S			2560	2980	3400	3820	4235	4655			
30 S			2690	3130	3570	4010	4450	4890			
10 LT S			3180	3700	4220	4740	5260	5780	6180	6375	7225
10 HT S			2690	3130	3570	4010	4450	4890			

### TM700 ProgressiveTraction®

Radial tire for tractors



SIZE	Tread pattern	SW mm	OD mm	SLR mm	RC mm	SRI	Rim	Permitted Rims	Type	Tube			
620/70R42 166D	TM700 ProgressiveTraction®	630	1930	870	5820	925	DW20B	DW18L - W18L	TUBELESS				
<b>PRESSURE</b>										<b>H</b>			
<b>psi</b>			<b>9</b>	<b>12</b>	<b>14</b>	<b>17</b>	<b>20</b>	<b>23</b>	<b>29</b>	<b>35</b>	<b>41</b>	<b>42</b>	<b>44</b>
<b>bar</b>			<b>0,6</b>	<b>0,8</b>	<b>1,0</b>	<b>1,2</b>	<b>1,4</b>	<b>1,6</b>	<b>2,0</b>	<b>2,4</b>	<b>2,8</b>	<b>2,9</b>	<b>3,0</b>
<b>MAX. LOAD kg</b>													
<b>65 S</b>			2495	2865	3290	3710	4135	4560	4985	<b>5300</b>			
50 S			2620	3010	3455	3900	4345	4790	5235	5565			
40 S			2730	3135	3600	4065	4530	4995	5460	5805			
30 S			2865	3295	3780	4270	4755	5245	5730	6095			
10 LT S			3390	3895	4470	5050	5625	6200	6780	7210	7715	7950	9010
10 HT S			2865	3295	3780	4270	4755	5245	5730	6095			

For technical notes about pressure tables please refer to page 260.



# TM700

Line in /70 series, very well known for its performance and versatility, capable of optimising the tractors efficiency during its whole life cycle.

Product plus:

- maximum self-cleaning
- excellent traction
- high level of handling and comfort on the road



SIZE	
300/70R20	110A8 (110B)
320/70R20	113A8 (113B)
360/70R20	120A8 (120B)
380/70R20	122A8 (122B)
320/70R24	116A8 (116B)
360/70R24	122A8 (122B)
380/70R24	125A8 (125B)
420/70R24	130A8 (130B)
480/70R24	138A8 (138B)
480/70R26	139A8 (139B)
320/70R28	119A8 (119B)
360/70R28	125A8 (125B)
380/70R28	127A8 (127B)
420/70R28	133D

SIZE	
480/70R28	140D
480/70R28	145D (148A8)
420/70R30	134A8 (134B)
480/70R30	141D
520/70R30	145A8 (145B)
480/70R34	143A8 (143B)
480/70R34	155A8 (155B)
520/70R34	148A8 (148B)
480/70R38	145A8 (145B)
520/70R38	150D
580/70R38	155D
580/70R42	158D
620/70R42	166D

SIZE	Tread pattern	SW mm	OD mm	SLR mm	RC mm	SRI	Rim	Permitted Rims	Type	Tube
300/70R20 110A8 (110B)	TM700	286	945	429	2805	450	W9	W10 - DW10	TUBELESS	9.5-20 TR218

## PRESSURE

	psi	6	9	12	14	17	20	23	26	28	30
bar		0,4	0,6	0,8	1,0	1,2	1,4	1,6	1,8	1,9	2,1

## MAX. LOAD kg

	50 S	40 S	30 S	10 LT S	10 HT S
	695	695	750	845	750
	770	770	825	945	825
	840	840	905	1050	905
	915	915	985	1150	985
	990	990	1060	1250	1060
	1060	<b>1060</b>	1140	1340	1140
				1440	
				1540	
				1590	
				1800	

## TM700

Radial tire for tractors



SIZE	Tread pattern	SW mm	OD mm	SLR mm	RC mm	SRI	Rim	Permitted Rims	Type	Tube		
<b>320/70R20</b> 113A8 (113B)	<b>TM700</b>	318	975	439	2905	475	W10	W9 - W11 - DW10 DW11	TUBELESS	11.2-20 TR218		
<b>PRESSURE</b>										<b>H</b>		
psi			<b>6</b>	<b>9</b>	<b>12</b>	<b>14</b>	<b>17</b>	<b>20</b>	<b>23</b>	<b>26</b>	<b>28</b>	<b>30</b>
bar			<b>0,4</b>	<b>0,6</b>	<b>0,8</b>	<b>1,0</b>	<b>1,2</b>	<b>1,4</b>	<b>1,6</b>	<b>1,8</b>	<b>1,9</b>	<b>2,1</b>
<b>MAX. LOAD kg</b>												
50 S				755	835	915	995	1070	1150			
<b>40 S</b>				755	835	915	995	1070	<b>1150</b>			
30 S				805	890	975	1060	1150	1230			
10 LT S			920	1030	1140	1250	1350	1460	1570	1680	1730	1960
10 HT S				805	890	975	1060	1150	1230			

SIZE	Tread pattern	SW mm	OD mm	SLR mm	RC mm	SRI	Rim	Permitted Rims	Type	Tube		
<b>360/70R20</b> 120A8 (120B)	<b>TM700</b>	352	1038	464	3100	500	W11	W10 - W12 - DW10 DW11 - DW12	TUBELESS	11.2-20 TR218		
<b>PRESSURE</b>										<b>H</b>		
psi			<b>6</b>	<b>9</b>	<b>12</b>	<b>14</b>	<b>17</b>	<b>20</b>	<b>23</b>	<b>26</b>	<b>28</b>	<b>30</b>
bar			<b>0,4</b>	<b>0,6</b>	<b>0,8</b>	<b>1,0</b>	<b>1,2</b>	<b>1,4</b>	<b>1,6</b>	<b>1,8</b>	<b>1,9</b>	<b>2,1</b>
<b>MAX. LOAD kg</b>												
50 S				920	1020	1110	1210	1310	1400			
<b>40 S</b>				920	1020	1110	1210	1310	<b>1400</b>			
30 S				985	1090	1190	1300	1400	1500			
10 LT S			1120	1250	1380	1510	1640	1770	1910	2040	2100	2380
10 HT S				985	1090	1190	1300	1400	1500			

SIZE	Tread pattern	SW mm	OD mm	SLR mm	RC mm	SRI	Rim	Permitted Rims	Type	Tube		
<b>380/70R20</b> 122A8 (122B)	<b>TM700</b>	370	1088	485	3240	525	W12	W11 - W13 - DW11 DW12 - DW13	TUBELESS	14.5/80-20 TR15		
<b>PRESSURE</b>										<b>H</b>		
psi			<b>6</b>	<b>9</b>	<b>12</b>	<b>14</b>	<b>17</b>	<b>20</b>	<b>23</b>	<b>26</b>	<b>28</b>	<b>30</b>
bar			<b>0,4</b>	<b>0,6</b>	<b>0,8</b>	<b>1,0</b>	<b>1,2</b>	<b>1,4</b>	<b>1,6</b>	<b>1,8</b>	<b>1,9</b>	<b>2,1</b>
<b>MAX. LOAD kg</b>												
50 S				985	1090	1190	1300	1400	1500			
<b>40 S</b>				985	1090	1190	1300	1400	<b>1500</b>			
30 S				1060	1170	1280	1390	1500	1610			
10 LT S			1200	1340	1480	1620	1760	1900	2040	2180	2250	2550
10 HT S				1060	1170	1280	1390	1500	1610			

SIZE	Tread pattern	SW mm	OD mm	SLR mm	RC mm	SRI	Rim	Permitted Rims	Type	Tube		
<b>320/70R24</b> 116A8 (116B)	<b>TM700</b>	316	1099	508	3300	525	W10	W9 - W11 DW10 - DW11	TUBELESS	11.2-24 TR218		
<b>PRESSURE</b>										<b>H</b>		
psi			<b>6</b>	<b>9</b>	<b>12</b>	<b>14</b>	<b>17</b>	<b>20</b>	<b>23</b>	<b>26</b>	<b>28</b>	<b>30</b>
bar			<b>0,4</b>	<b>0,6</b>	<b>0,8</b>	<b>1,0</b>	<b>1,2</b>	<b>1,4</b>	<b>1,6</b>	<b>1,8</b>	<b>1,9</b>	<b>2,1</b>
<b>MAX. LOAD kg</b>												
50 S				820	905	995	1080	1170	1250			
<b>40 S</b>				820	905	995	1080	1170	<b>1250</b>			
30 S				880	970	1070	1160	1250	1340			
10 LT S			1000	1120	1240	1350	1470	1590	1710	1820	1880	2130
10 HT S				880	970	1070	1160	1250	1340			

SIZE	Tread pattern	SW mm	OD mm	SLR mm	RC mm	SRI	Rim	Permitted Rims	Type	Tube		
<b>360/70R24</b> 112A8 (125B)	<b>TM700</b>	352	1147	518	3425	550	W11	W10 - W12 - DW10 DW11 - DW12	TUBELESS	13.6-24 TR218		
<b>PRESSURE</b>										<b>H</b>		
psi			<b>6</b>	<b>9</b>	<b>12</b>	<b>14</b>	<b>17</b>	<b>20</b>	<b>23</b>	<b>26</b>	<b>28</b>	<b>30</b>
bar			<b>0,4</b>	<b>0,6</b>	<b>0,8</b>	<b>1,0</b>	<b>1,2</b>	<b>1,4</b>	<b>1,6</b>	<b>1,8</b>	<b>1,9</b>	<b>2,1</b>
<b>MAX. LOAD kg</b>												
50 S				985	1090	1190	1300	1400	1500			
<b>40 S</b>				985	1090	1190	1300	1400	<b>1500</b>			
30 S				1060	1170	1280	1390	1500	1610			
10 LT S			1200	1340	1480	1620	1760	1900	2040	2180	2250	2550
10 HT S				1060	1170	1280	1390	1500	1610			

SIZE	Tread pattern	SW mm	OD mm	SLR mm	RC mm	SRI	Rim	Permitted Rims	Type	Tube		
<b>380/70R24</b> 125A8 (125B)	<b>TM700</b>	370	1193	538	3560	575	W12	W11 - W13 - DW11 DW12 - DW13	TUBELESS	14.9-24 TR218		
<b>PRESSURE</b>										<b>H</b>		
psi			<b>6</b>	<b>9</b>	<b>12</b>	<b>14</b>	<b>17</b>	<b>20</b>	<b>23</b>	<b>26</b>	<b>28</b>	<b>30</b>
bar			<b>0,4</b>	<b>0,6</b>	<b>0,8</b>	<b>1,0</b>	<b>1,2</b>	<b>1,4</b>	<b>1,6</b>	<b>1,8</b>	<b>1,9</b>	<b>2,1</b>
<b>MAX. LOAD kg</b>												
50 S				1080	1200	1310	1430	1540	1650			
<b>40 S</b>				1080	1200	1310	1430	1540	<b>1650</b>			
30 S				1160	1280	1410	1530	1650	1770			
10 LT S			1320	1480	1630	1790	1940	2100	2250	2410	2480	2810
10 HT S				1160	1280	1410	1530	1650	1770			

## TM700

Radial tire for tractors



SIZE	Tread pattern	SW mm	OD mm	SLR mm	RC mm	SRI	Rim	Permitted Rims	Type	Tube		
<b>420/70R24</b> 130A8 (130B)	<b>TM700</b>	415	1253	562	3705	600	W13	W12 - W14L - DW12 DW13 - DW14L	TUBELESS	16.9-24 TR218		
<b>PRESSURE</b>										<b>H</b>		
psi			<b>6</b>	<b>9</b>	<b>12</b>	<b>14</b>	<b>17</b>	<b>20</b>	<b>23</b>	<b>26</b>	<b>28</b>	<b>30</b>
bar			<b>0,4</b>	<b>0,6</b>	<b>0,8</b>	<b>1,0</b>	<b>1,2</b>	<b>1,4</b>	<b>1,6</b>	<b>1,8</b>	<b>1,9</b>	<b>2,1</b>
<b>MAX. LOAD kg</b>												
50 S				1250	1380	1510	1640	1770	1900			
<b>40 S</b>				1250	1380	1510	1640	1770	<b>1900</b>			
30 S				1340	1480	1620	1760	1900	2040			
10 LT S			1520	1700	1870	2050	2230	2410	2590	2760	2850	3240
10 HT S				1340	1480	1620	1760	1900	2040			

SIZE	Tread pattern	SW mm	OD mm	SLR mm	RC mm	SRI	Rim	Permitted Rims	Type	Tube		
<b>480/70R24</b> 138A8 (138B)	<b>TM700</b>	468	1300	580	3875	625	W15L	W14L - W16L - DW14L DW15L - DW16L	TUBELESS	16.9-24 TR218		
<b>PRESSURE</b>										<b>H</b>		
psi			<b>6</b>	<b>9</b>	<b>12</b>	<b>14</b>	<b>17</b>	<b>20</b>	<b>23</b>	<b>26</b>	<b>28</b>	<b>30</b>
bar			<b>0,4</b>	<b>0,6</b>	<b>0,8</b>	<b>1,0</b>	<b>1,2</b>	<b>1,4</b>	<b>1,6</b>	<b>1,8</b>	<b>1,9</b>	<b>2,1</b>
<b>MAX. LOAD kg</b>												
50 S				1550	1710	1870	2040	2200	2360			
<b>40 S</b>				1550	1710	1870	2040	2200	<b>2360</b>			
30 S				1660	1840	2010	2180	2360	2530			
10 LT S			1880	2100	2330	2550	2770	2990	3220	3440	3540	4020
10 HT S				1660	1840	2010	2180	2360	2530			

SIZE	Tread pattern	SW mm	OD mm	SLR mm	RC mm	SRI	Rim	Permitted Rims	Type	Tube		
<b>480/70R26</b> 139A8 (139B)	<b>TM700</b>	468	1358	608	4060	650	W15L	W14L - W16L - DW14L DW15L - DW16L	TUBELESS	16.9-26 TR218		
<b>PRESSURE</b>										<b>H</b>		
psi			<b>6</b>	<b>9</b>	<b>12</b>	<b>14</b>	<b>17</b>	<b>20</b>	<b>23</b>	<b>26</b>	<b>28</b>	<b>30</b>
bar			<b>0,4</b>	<b>0,6</b>	<b>0,8</b>	<b>1,0</b>	<b>1,2</b>	<b>1,4</b>	<b>1,6</b>	<b>1,8</b>	<b>1,9</b>	<b>2,1</b>
<b>MAX. LOAD kg</b>												
50 S				1600	1760	1930	2100	2270	2430			
<b>40 S</b>				1600	1760	1930	2100	2270	<b>2430</b>			
30 S				1710	1890	2070	2240	2420	2600			
10 LT S			1950	2180	2400	2630	2860	3100	3320	3560	3660	4140
10 HT S				1710	1890	2070	2240	2420	2600			

SIZE	Tread pattern	SW mm	OD mm	SLR mm	RC mm	SRI	Rim	Permitted Rims	Type	Tube		
<b>320/70R28</b> 119A8 (119B)	<b>TM700</b>	316	1198	552	3605	575	W10	W9 - W11 - DW10 DW11	TUBELESS	12.4-28 TR218		
<b>PRESSURE</b>										<b>H</b>		
psi			<b>6</b>	<b>9</b>	<b>12</b>	<b>14</b>	<b>17</b>	<b>20</b>	<b>23</b>	<b>26</b>	<b>28</b>	<b>30</b>
bar			<b>0,4</b>	<b>0,6</b>	<b>0,8</b>	<b>1,0</b>	<b>1,2</b>	<b>1,4</b>	<b>1,6</b>	<b>1,8</b>	<b>1,9</b>	<b>2,1</b>
<b>MAX. LOAD kg</b>												
50 S				895	985	1080	1180	1270	1360			
<b>40 S</b>				895	985	1080	1180	1270	<b>1360</b>			
30 S				960	1060	1160	1260	1360	1460			
10 LT S			1090	1210	1340	1470	1600	1720	1850	1980	2040	2310
10 HT S				960	1060	1160	1260	1360	1460			

According to availability

SIZE	Tread pattern	SW mm	OD mm	SLR mm	RC mm	SRI	Rim	Permitted Rims	Type	Tube		
<b>360/70R28</b> 125A8 (125B)	<b>TM700</b>	352	1246	568	3745	600	W11	W10 - W12 - DW10 DW11 - DW12	TUBELESS	12.4-28 TR218		
<b>PRESSURE</b>										<b>H</b>		
psi			<b>6</b>	<b>9</b>	<b>12</b>	<b>14</b>	<b>17</b>	<b>20</b>	<b>23</b>	<b>26</b>	<b>28</b>	<b>30</b>
bar			<b>0,4</b>	<b>0,6</b>	<b>0,8</b>	<b>1,0</b>	<b>1,2</b>	<b>1,4</b>	<b>1,6</b>	<b>1,8</b>	<b>1,9</b>	<b>2,1</b>
<b>MAX. LOAD kg</b>												
50 S				1080	1200	1310	1430	1540	1650			
<b>40 S</b>				1080	1200	1310	1430	1540	<b>1650</b>			
30 S				1160	1280	1410	1530	1650	1770			
10 LT S			1320	1480	1630	1790	1940	2100	2250	2410	2480	2810
10 HT S				1160	1280	1410	1530	1650	1770			

SIZE	Tread pattern	SW mm	OD mm	SLR mm	RC mm	SRI	Rim	Permitted Rims	Type	Tube		
<b>380/70R28</b> 127A8 (127B)	<b>TM700</b>	370	1292	590	3895	625	W12	W11 - W13 - DW11 DW12 - DW13	TUBELESS	12.4-28 TR218		
<b>PRESSURE</b>										<b>H</b>		
psi			<b>6</b>	<b>9</b>	<b>12</b>	<b>14</b>	<b>17</b>	<b>20</b>	<b>23</b>	<b>26</b>	<b>28</b>	<b>30</b>
bar			<b>0,4</b>	<b>0,6</b>	<b>0,8</b>	<b>1,0</b>	<b>1,2</b>	<b>1,4</b>	<b>1,6</b>	<b>1,8</b>	<b>1,9</b>	<b>2,1</b>
<b>MAX. LOAD kg</b>												
50 S				1150	1270	1390	1510	1630	1750			
<b>40 S</b>				1150	1270	1390	1510	1630	<b>1750</b>			
30 S				1230	1360	1490	1620	1750	1880			
10 LT S			1400	1560	1730	1890	2060	2220	2390	2550	2630	2980
10 HT S				1230	1360	1490	1620	1750	1880			

## TM700

Radial tire for tractors



SIZE	Tread pattern	SW mm	OD mm	SLR mm	RC mm	SRI	Rim	Permitted Rims	Type	Tube		
420/70R28 133D	TM700	415	1354	608	4025	650	W13	W12 - W14L - DW12 DW13 - DW14L	TUBELESS	16.9-28 TR218		
<b>PRESSURE</b>										<b>H</b>		
		<b>psi</b>		<b>9</b>	<b>12</b>	<b>14</b>	<b>17</b>	<b>20</b>	<b>23</b>	<b>26</b>	<b>28</b>	<b>30</b>
		<b>bar</b>		<b>0,6</b>	<b>0,8</b>	<b>1,0</b>	<b>1,2</b>	<b>1,4</b>	<b>1,6</b>	<b>1,8</b>	<b>1,9</b>	<b>2,1</b>
<b>MAX. LOAD kg</b>												
<b>65 S</b>			1135	1320	1505	1690	1875	<b>2060</b>				
50 S			1190	1385	1580	1775	1970	2165				
40 S			1245	1445	1650	1850	2055	2260				
30 S			1305	1520	1730	1945	2160	2370				
10 LT S			1545	1795	2050	2300	2550	2805	2995	3090	3505	
10 HT S			1305	1520	1730	1945	2160	2370				

SIZE	Tread pattern	SW mm	OD mm	SLR mm	RC mm	SRI	Rim	Permitted Rims	Type	Tube		
480/70R28 140D	TM700	468	1415	636	4190	675	W15L	W14L - W16L - DW14L DW15L - DW16L	TUBELESS	16.9-28 TR218		
<b>PRESSURE</b>										<b>H</b>		
		<b>psi</b>		<b>9</b>	<b>12</b>	<b>14</b>	<b>17</b>	<b>20</b>	<b>23</b>	<b>26</b>	<b>28</b>	<b>30</b>
		<b>bar</b>		<b>0,6</b>	<b>0,8</b>	<b>1,0</b>	<b>1,2</b>	<b>1,4</b>	<b>1,6</b>	<b>1,8</b>	<b>1,9</b>	<b>2,1</b>
<b>MAX. LOAD kg</b>												
<b>65 S</b>			1375	1600	1825	2050	2275	<b>2500</b>				
50 S			1445	1680	1920	2155	2390	2625				
40 S			1510	1755	2000	2245	2495	2740				
30 S			1585	1840	2100	2360	2620	2875				
10 LT S			1870	2180	2485	2790	3095	3400	3635	3750	4250	
10 HT S			1585	1840	2100	2360	2620	2875				

SIZE	Tread pattern	SW mm	OD mm	SLR mm	RC mm	SRI	Rim	Permitted Rims	Type	Tube	
480/70R28 145D (148A8)	TM700	468	1415	636	4240	675	W15L	W14L - W16L	TUBELESS	16.9-28 TR218	
<b>PRESSURE</b>										<b>H</b>	
		<b>psi</b>		<b>9</b>	<b>12</b>	<b>17</b>	<b>23</b>	<b>29</b>	<b>35</b>	<b>41</b>	<b>46</b>
		<b>bar</b>		<b>0,6</b>	<b>0,8</b>	<b>1,2</b>	<b>1,6</b>	<b>2,0</b>	<b>2,4</b>	<b>2,8</b>	<b>3,2</b>
<b>MAX. LOAD kg</b>											
<b>65 S</b>			1625	1830	2170	2450	2685	<b>2900</b>			
50 S			1705	1925	2280	2570	2820	3045			
40 S			1780	2005	2375	2680	2940	3175			
30 S			1870	2105	2495	2815	3090	3335			
10 LT S			2285	2575	3055	3445	3780	4080	4350	5400	
10 HT S			1870	2105	2495	2815	3090	3335			



SIZE	Tread pattern	SW mm	OD mm	SLR mm	RC mm	SRI	Rim	Permitted Rims	Type	Tube		
<b>420/70R30</b> 134A8 (134B)	<b>TM700</b>	415	1400	636	4204	675	W13	W12 - W14L - DW12L DW13L - DW14L	TUBELESS	14.9-30 TR218		
<b>PRESSURE</b>										<b>H</b>		
psi			<b>6</b>	<b>9</b>	<b>12</b>	<b>14</b>	<b>17</b>	<b>20</b>	<b>23</b>	<b>26</b>	<b>28</b>	<b>30</b>
bar			<b>0,4</b>	<b>0,6</b>	<b>0,8</b>	<b>1,0</b>	<b>1,2</b>	<b>1,4</b>	<b>1,6</b>	<b>1,8</b>	<b>1,9</b>	<b>2,1</b>
<b>MAX. LOAD kg</b>												
50 S				1390	1540	1680	1830	1980	2120			
<b>40 S</b>				1390	1540	1680	1830	1980	<b>2120</b>			
30 S				1490	1650	1800	1960	2120	2270			
10 LT S			1690	1890	2090	2290	2490	2690	2880	3080	3180	3600
10 HT S				1490	1650	1800	1960	2120	2270			

SIZE	Tread pattern	SW mm	OD mm	SLR mm	RC mm	SRI	Rim	Permitted Rims	Type	Tube	
<b>480/70R30</b> 141D	<b>TM700</b>	468	1474	667	4425	700	W15L	W14L - W16L - DW14L DW15L - DW16L	TUBELESS	18.4-30 TR218	
<b>PRESSURE</b>										<b>H</b>	
psi			<b>9</b>	<b>12</b>	<b>14</b>	<b>17</b>	<b>20</b>	<b>23</b>	<b>26</b>	<b>28</b>	<b>30</b>
bar			<b>0,6</b>	<b>0,8</b>	<b>1,0</b>	<b>1,2</b>	<b>1,4</b>	<b>1,6</b>	<b>1,8</b>	<b>1,9</b>	<b>2,1</b>
<b>MAX. LOAD kg</b>											
<b>65 S</b>			1420	1650	1880	2115	2345	<b>2575</b>			
50 S			1490	1735	1975	2220	2465	2705			
40 S			1555	1805	2060	2315	2570	2820			
30 S			1630	1900	2165	2430	2695	2965			
10 LT S			1930	2245	2560	2875	3190	3505	3745	3865	4380
10 HT S			1630	1900	2165	2430	2695	2965			

SIZE	Tread pattern	SW mm	OD mm	SLR mm	RC mm	SRI	Rim	Permitted Rims	Type	Tube		
<b>520/70R30</b> 145A8 (145B)	<b>TM700</b>	520	1535	680	4590	725	W16L	W15L - W18L - DW15L DW16L - DW18L	TUBELESS	18.4-30 TR218		
<b>PRESSURE</b>										<b>H</b>		
psi			<b>6</b>	<b>9</b>	<b>12</b>	<b>14</b>	<b>17</b>	<b>20</b>	<b>23</b>	<b>26</b>	<b>28</b>	<b>30</b>
bar			<b>0,4</b>	<b>0,6</b>	<b>0,8</b>	<b>1,0</b>	<b>1,2</b>	<b>1,4</b>	<b>1,6</b>	<b>1,8</b>	<b>1,9</b>	<b>2,1</b>
<b>MAX. LOAD kg</b>												
50 S				1900	2100	2300	2500	2700	2900			
<b>40 S</b>				1900	2100	2300	2500	2700	<b>2900</b>			
30 S				2030	2250	2460	2680	2890	3100			
10 LT S			2320	2590	2860	3140	3420	3680	3960	4220	4360	4940
10 HT S				2030	2250	2460	2680	2890	3100			

## TM700

Radial tire for tractors



SIZE	Tread pattern	SW mm	OD mm	SLR mm	RC mm	SRI	Rim	Permitted Rims	Type	Tube		
<b>480/70R34</b> 143A8 (143B)	<b>TM700</b>	468	1580	716	4720	750	W15L	W14L - W16L - DW14L DW15L - DW16L	TUBELESS	16.9-34 TR218		
<b>PRESSURE</b>										<b>H</b>		
<b>psi</b>			<b>6</b>	<b>9</b>	<b>12</b>	<b>14</b>	<b>17</b>	<b>20</b>	<b>23</b>	<b>26</b>	<b>28</b>	<b>30</b>
<b>bar</b>			<b>0,4</b>	<b>0,6</b>	<b>0,8</b>	<b>1,0</b>	<b>1,2</b>	<b>1,4</b>	<b>1,6</b>	<b>1,8</b>	<b>1,9</b>	<b>2,1</b>
<b>MAX. LOAD kg</b>												
50 S				1790	1980	2170	2360	2540	2725			
<b>40 S</b>				1790	1980	2170	2360	2540	<b>2725</b>			
30 S				1920	2120	2320	2520	2720	2920			
10 LT S			2180	2440	2690	2950	3200	3460	3720	3980	4100	4640
10 HT S				1920	2120	2320	2520	2720	2920			

SIZE	Tread pattern	SW mm	OD mm	SLR mm	RC mm	SRI	Rim	Permitted Rims	Type	Tube			
<b>480/70R34</b> 155A8 (155B)	<b>TM700</b>	465	1580	727	4720	750	W15L	W14L - DW14L - DW15L W16L - DW16L	TUBELESS	16.9-34 TR218			
<b>PRESSURE</b>										<b>H</b>			
<b>psi</b>			<b>12</b>	<b>14</b>	<b>17</b>	<b>20</b>	<b>23</b>	<b>29</b>	<b>35</b>	<b>41</b>	<b>46</b>	<b>49</b>	<b>55</b>
<b>bar</b>			<b>0,8</b>	<b>1,0</b>	<b>1,2</b>	<b>1,4</b>	<b>1,6</b>	<b>2,0</b>	<b>2,4</b>	<b>2,8</b>	<b>3,2</b>	<b>3,4</b>	<b>3,8</b>
<b>MAX. LOAD kg</b>													
50 S			1785	2055	2290	2560	2790	3065	3295	3605	3875		
<b>40 S</b>			1785	2055	2290	2560	2790	3065	3295	3605	<b>3875</b>		
30 S			1910	2200	2455	2740	2990	3280	3530	3860	4150		
10 LT S			2210	2545	2920	3345	3695	4295	4635	5070	5350	5600	5815
10 HT S			1910	2200	2455	2740	2990	3280	3530	3860	4150		

SIZE	Tread pattern	SW mm	OD mm	SLR mm	RC mm	SRI	Rim	Permitted Rims	Type	Tube		
<b>520/70R34</b> 148A8 (148B)	<b>TM700</b>	520	1638	728	4875	775	W16L	W15L - W18L DW15L - DW16L	TUBELESS	16.9-34 TR218		
<b>PRESSURE</b>										<b>H</b>		
<b>psi</b>			<b>6</b>	<b>9</b>	<b>12</b>	<b>14</b>	<b>17</b>	<b>20</b>	<b>23</b>	<b>26</b>	<b>28</b>	<b>30</b>
<b>bar</b>			<b>0,4</b>	<b>0,6</b>	<b>0,8</b>	<b>1,0</b>	<b>1,2</b>	<b>1,4</b>	<b>1,6</b>	<b>1,8</b>	<b>1,9</b>	<b>2,1</b>
<b>MAX. LOAD kg</b>												
50 S				2070	2290	2510	2730	2950	3150			
<b>40 S</b>				2070	2290	2510	2730	2950	<b>3150</b>			
30 S				2220	2450	2680	2920	3160	3380			
10 LT S			2520	2820	3120	3420	3700	4000	4300	4600	4740	5360
10 HT S				2220	2450	2680	2920	3160	3380			

SIZE	Tread pattern	SW mm	OD mm	SLR mm	RC mm	SRI	Rim	Permitted Rims	Type	Tube		
<b>480/70R38</b> 145A8 (145B)	<b>TM700</b>	468	1684	760	5055	800	W15L	W14L - W16L - DW14L DW15L - DW16L	TUBELESS	18.4-38 TR218		
<b>PRESSURE</b>										<b>H</b>		
psi			<b>6</b>	<b>9</b>	<b>12</b>	<b>14</b>	<b>17</b>	<b>20</b>	<b>23</b>	<b>26</b>	<b>28</b>	<b>30</b>
bar			<b>0,4</b>	<b>0,6</b>	<b>0,8</b>	<b>1,0</b>	<b>1,2</b>	<b>1,4</b>	<b>1,6</b>	<b>1,8</b>	<b>1,9</b>	<b>2,1</b>
<b>MAX. LOAD kg</b>												
50 S				1900	2100	2300	2500	2700	2900			
<b>40 S</b>				1900	2100	2300	2500	2700	<b>2900</b>			
30 S				2030	2250	2460	2680	2890	3100			
10 LT S			2320	2590	2860	3140	3420	3680	3960	4220	4360	4940
10 HT S				2030	2250	2460	2680	2890	3100			

SIZE	Tread pattern	SW mm	OD mm	SLR mm	RC mm	SRI	Rim	Permitted Rims	Type	Tube	
<b>520/70R38</b> 150D	<b>TM700</b>	520	1740	774	5150	825	W16L	W15L - W18L - DW15L DW16L - DW18L	TUBELESS	18.4-38 TR218	
<b>PRESSURE</b>										<b>H</b>	
psi			<b>9</b>	<b>12</b>	<b>14</b>	<b>17</b>	<b>20</b>	<b>23</b>	<b>26</b>	<b>28</b>	<b>30</b>
bar			<b>0,6</b>	<b>0,8</b>	<b>1,0</b>	<b>1,2</b>	<b>1,4</b>	<b>1,6</b>	<b>1,8</b>	<b>1,9</b>	<b>2,1</b>
<b>MAX. LOAD kg</b>											
<b>65 S</b>			1845	2145	2450	2750	3050	<b>3350</b>			
50 S			1935	2255	2570	2885	3205	3520			
40 S			2020	2350	2680	3010	3340	3670			
30 S			2120	2470	2815	3160	3510	3855			
10 LT S			2510	2920	3330	3740	4150	4560	4875	5025	5695
10 HT S			2120	2470	2815	3160	3510	3855			

SIZE	Tread pattern	SW mm	OD mm	SLR mm	RC mm	SRI	Rim	Permitted Rims	Type	Tube	
<b>580/70R38</b> 155D	<b>TM700</b>	584	1825	822	5380	875	W18L	DW18L	TUBELESS	20.8-38 TR218	
<b>PRESSURE</b>										<b>H</b>	
psi			<b>9</b>	<b>12</b>	<b>14</b>	<b>17</b>	<b>20</b>	<b>23</b>	<b>26</b>	<b>28</b>	<b>30</b>
bar			<b>0,6</b>	<b>0,8</b>	<b>1,0</b>	<b>1,2</b>	<b>1,4</b>	<b>1,6</b>	<b>1,8</b>	<b>1,9</b>	<b>2,1</b>
<b>MAX. LOAD kg</b>											
<b>65 S</b>			2135	2480	2830	3180	3530	<b>3875</b>			
50 S			2240	2605	2975	3340	3705	4070			
40 S			2335	2720	3100	3480	3865	4245			
30 S			2455	2855	3255	3655	4060	4460			
10 LT S			2900	3375	3850	4325	4800	5270	5635	5815	6590
10 HT S			2455	2855	3255	3655	4060	4460			

## TM700

Radial tire for tractors



SIZE	Tread pattern	SW mm	OD mm	SLR mm	RC mm	SRI	Rim	Permitted Rims	Type	Tube	
580/70R42 158D	TM700	584	1908	864	5690	900	W18L	DW18L	TUBELESS	20.8-42 TR218	
<b>PRESSURE</b>										<b>H</b>	
psi			<b>9</b>	<b>12</b>	<b>14</b>	<b>17</b>	<b>20</b>	<b>23</b>	<b>26</b>	<b>28</b>	<b>30</b>
bar			<b>0,6</b>	<b>0,8</b>	<b>1,0</b>	<b>1,2</b>	<b>1,4</b>	<b>1,6</b>	<b>1,8</b>	<b>1,9</b>	<b>2,1</b>
<b>MAX. LOAD kg</b>											
<b>65 S</b>			2340	2720	3105	3485	3870	<b>4250</b>			
50 S			2455	2860	3260	3660	4065	4465			
40 S			2560	2980	3400	3820	4235	4655			
30 S			2690	3130	3570	4010	4450	4890			
10 LT S			3180	3700	4220	4740	5260	5780	6180	6375	7225
10 HT S			2690	3130	3570	4010	4450	4890			

SIZE	Tread pattern	SW mm	OD mm	SLR mm	RC mm	SRI	Rim	Permitted Rims	Type	Tube			
620/70R42 166D	TM700	625	1935	871	5855	925	DW20B	DW18L - W18L	TUBELESS				
<b>PRESSURE</b>										<b>H</b>			
psi			<b>9</b>	<b>12</b>	<b>14</b>	<b>17</b>	<b>20</b>	<b>23</b>	<b>29</b>	<b>35</b>	<b>41</b>	<b>42</b>	<b>43</b>
bar			<b>0,6</b>	<b>0,8</b>	<b>1,0</b>	<b>1,2</b>	<b>1,4</b>	<b>1,6</b>	<b>2,0</b>	<b>2,4</b>	<b>2,8</b>	<b>2,9</b>	<b>3,0</b>
<b>MAX. LOAD kg</b>													
<b>65 S</b>			2495	2865	3290	3710	4135	4560	4985	<b>5300</b>			
50 S			2620	3010	3455	3900	4345	4790	5235	5565			
40 S			2730	3135	3600	4065	4530	4995	5460	5805			
30 S			2865	3295	3780	4270	4755	5245	5730	6095			
10 LT S			3390	3895	4470	5050	5625	6200	6780	7210	7715	7950	9010
10 HT S			2865	3295	3780	4270	4755	5245	5730	6095			

For technical notes about pressure tables please refer to page 260.

## TM700



Radial tire designed for orchards and vineyard work. It equips medium-to-low horsepower tractors with both front and rear drive wheels. Thanks to its tested radial structure, it solves the yield problems resulting from the traditional use of the cross-ply sizes on these tractors.



## SIZE

**240/70R16 104A8 (104B)**

**260/70R16 109A8 (109B)**

**280/70R16 112A8 (112B)**

## SIZE

**280/70R18 114A8 (114B)**

**280/70R20 116A8 (116B)**

SIZE	Tread pattern	SW mm	OD mm	SLR mm	RC mm	SRI	Rim	Permitted Rims	Type	Tube		
<b>240/70R16</b> 104A8 (104B)	<b>TM700</b>	244	742	340	2195	350	W8	W8L - W9	TUBELESS	7.50-16 TR15		
<b>PRESSURE</b>										<b>H</b>		
psi			<b>6</b>	<b>9</b>	<b>12</b>	<b>17</b>	<b>23</b>	<b>29</b>	<b>35</b>	<b>41</b>	<b>42</b>	<b>43</b>
bar			<b>0,4</b>	<b>0,6</b>	<b>0,8</b>	<b>1,2</b>	<b>1,6</b>	<b>2,0</b>	<b>2,4</b>	<b>2,8</b>	<b>2,9</b>	<b>3,0</b>
<b>MAX. LOAD kg</b>												
50 S					425	490	630	775	850	900		
<b>40 S</b>					425	490	630	775	850	<b>900</b>		
30 S					455	525	675	830	910	965		
10 LT S			555	620	685	815	945	1070	1195	1320	1350	1530
10 HT S				455	525	675	830	910	965			

SIZE	Tread pattern	SW mm	OD mm	SLR mm	RC mm	SRI	Rim	Permitted Rims	Type	Tube		
<b>260/70R16</b> 109A8 (109B)	<b>TM700</b>	258	770	340	2310	360	W8	W8L - W9	TUBELESS	9.00-16 TR15		
<b>PRESSURE</b>										<b>H</b>		
psi			<b>6</b>	<b>9</b>	<b>12</b>	<b>17</b>	<b>23</b>	<b>29</b>	<b>35</b>	<b>41</b>	<b>42</b>	<b>43</b>
bar			<b>0,4</b>	<b>0,6</b>	<b>0,8</b>	<b>1,2</b>	<b>1,6</b>	<b>2,0</b>	<b>2,4</b>	<b>2,8</b>	<b>2,9</b>	<b>3,0</b>
<b>MAX. LOAD kg</b>												
50 S					530	590	700	810	920	1030		
<b>40 S</b>					530	590	700	810	920	<b>1030</b>		
30 S					570	630	750	870	980	1100		
10 LT S			620	690	760	910	1060	1210	1360	1510	1550	1750
10 HT S				570	630	750	870	980	1100			

SIZE	Tread pattern	SW mm	OD mm	SLR mm	RC mm	SRI	Rim	Permitted Rims	Type	Tube		
<b>280/70R16</b> 112A8 (112B)	<b>TM700</b>	282	798	355	2385	380	W9	W8 - W8L - W10	TUBELESS	10.00-16 TR15		
<b>PRESSURE</b>										<b>H</b>		
<b>psi</b>		<b>6</b>	<b>9</b>	<b>12</b>	<b>17</b>	<b>23</b>	<b>29</b>	<b>35</b>	<b>41</b>	<b>42</b>	<b>43</b>	
<b>bar</b>		<b>0,4</b>	<b>0,6</b>	<b>0,8</b>	<b>1,2</b>	<b>1,6</b>	<b>2,0</b>	<b>2,4</b>	<b>2,8</b>	<b>2,9</b>	<b>3,0</b>	
<b>MAX. LOAD kg</b>												
50 S				580	640	760	880	1000	1120			
<b>40 S</b>				580	640	760	880	1000	<b>1120</b>			
30 S				620	680	810	940	1070	1200			
10 LT S			680	760	840	1000	1160	1320	1480	1640	1680	1900
10 HT S				620	680	810	940	1070	1200			

SIZE	Tread pattern	SW mm	OD mm	SLR mm	RC mm	SRI	Rim	Permitted Rims	Type	Tube		
<b>280/70R18</b> 114A8 (114B)	<b>TM700</b>	282	849	380	2560	410	W9	W8 - W8L - W10	TUBELESS	10.5/80-18 TR218		
<b>PRESSURE</b>										<b>H</b>		
<b>psi</b>		<b>6</b>	<b>9</b>	<b>12</b>	<b>17</b>	<b>23</b>	<b>29</b>	<b>35</b>	<b>41</b>	<b>42</b>	<b>43</b>	
<b>bar</b>		<b>0,4</b>	<b>0,6</b>	<b>0,8</b>	<b>1,2</b>	<b>1,6</b>	<b>2,0</b>	<b>2,4</b>	<b>2,8</b>	<b>2,9</b>	<b>3,0</b>	
<b>MAX. LOAD kg</b>												
50 S				600	660	790	920	1050	1180			
<b>40 S</b>				600	660	790	920	1050	<b>1180</b>			
30 S				640	710	850	980	1120	1260			
10 LT S			720	800	880	1050	1220	1390	1560	1730	1770	2010
10 HT S				640	710	850	980	1120	1260			

SIZE	Tread pattern	SW mm	OD mm	SLR mm	RC mm	SRI	Rim	Permitted Rims	Type	Tube		
<b>280/70R20</b> 116A8 (116B)	<b>TM700</b>	279	910	410	2745	450	W9	W10	TUBELESS	9.5-20 TR218		
<b>PRESSURE</b>										<b>H</b>		
<b>psi</b>		<b>6</b>	<b>9</b>	<b>12</b>	<b>17</b>	<b>23</b>	<b>29</b>	<b>35</b>	<b>41</b>	<b>42</b>	<b>43</b>	
<b>bar</b>		<b>0,4</b>	<b>0,6</b>	<b>0,8</b>	<b>1,2</b>	<b>1,6</b>	<b>2,0</b>	<b>2,4</b>	<b>2,8</b>	<b>2,9</b>	<b>3,0</b>	
<b>MAX. LOAD kg</b>												
50 S				590	675	875	1075	1175	1250			
<b>40 S</b>				590	675	875	1075	1175	<b>1250</b>			
30 S				630	725	940	1155	1260	1340			
10 LT S			765	855	945	1125	1305	1485	1660	1835	1875	2125
10 HT S				630	725	940	1155	1260	1340			

For technical notes about pressure tables please refer to page 260.



# TM700 HIGH SPEED

The TM700 High Speed is the agriculture radial tire with high lugs yet suitable for speed up to 65 Km/hour. Intended for tractors equipped with integral or partial suspensions, it's a tire that stands out due to its excellent performance both on the road and in the field. In fact, though it reveals an emphasised road look, the TM700 High Speed delivers unmatched performance in terms of traction and low compaction in the field.



## SIZE

**480/70R30      147D (144E)**

**520/70R30      151D (148E)**

SIZE	Tread pattern	SW mm	OD mm	SLR mm	RC mm	SRI	Rim	Permitted Rims	Type	Tube
<b>480/70R30</b> 147D (144E)	<b>TM700 HS</b>	468	1474	667	4430	700	W15L	W14L - W16L - DW14L DW15L - DW16L	TUBELESS	18.4-30 TR218

### PRESSURE

<b>psi</b>	<b>6</b>	<b>9</b>	<b>12</b>	<b>17</b>	<b>23</b>	<b>26</b>	<b>29</b>	<b>32</b>	<b>35</b>
<b>bar</b>	<b>0,4</b>	<b>0,6</b>	<b>0,8</b>	<b>1,2</b>	<b>1,6</b>	<b>1,8</b>	<b>2,0</b>	<b>2,2</b>	<b>2,4</b>

### MAX. LOAD kg

70 S							2055	2240	2425	2615	2800
<b>65 S</b>							2255	2460	2665	2870	<b>3075</b>
50 S			1540	1700	2030	2360	2585	2800	3015	3230	
40 S			1595	1765	2105	2435	2680	2900	3125	3350	
30 S			1810	2000	2380	2760					
10 LT S		2050	2290	2540	3020	3500	3740				
10 HT S			1810	2000	2380	2760					

SIZE	Tread pattern	SW mm	OD mm	SLR mm	RC mm	SRI	Rim	Permitted Rims	Type	Tube
<b>520/70R30</b> 151D (148E)	<b>TM700 HS</b>	520	1535	680	4615	725	W16L	W15L - W18L - DW15L DW16L - DW18L	TUBELESS	18.4-30 TR218

### PRESSURE

<b>psi</b>	<b>9</b>	<b>12</b>	<b>14</b>	<b>17</b>	<b>20</b>	<b>23</b>	<b>29</b>	<b>35</b>
<b>bar</b>	<b>0,6</b>	<b>0,8</b>	<b>1,0</b>	<b>1,2</b>	<b>1,4</b>	<b>1,6</b>	<b>2,0</b>	<b>2,4</b>

### MAX. LOAD kg

70 S		1475	1695	1945	2200	2450	2725	2950	3150
<b>65 S</b>		1620	1865	2140	2415	2690	2900	3245	<b>3450</b>
50 S		1705	1955	2245	2535	2825	3150	3405	3650
40 S		1775	2040	2340	2645	2945	3250	3550	3750
30 S		1865	2140	2460	2775	3095	3450	3730	4000
10 LT S			2430	2795	3210	3625	4035	4500	
10 HT S		1865	2140	2460	2775	3095	3450		

For technical notes about pressure tables please refer to page 260.

## TM700 HIGH SPEED

Radial tire for tractors





The new PneuTrac® contains the best-in-class features of Trelleborg agricultural tires along with a new sidewall: the CupWheel Technology\*. The innovative “Omega” design of the sidewall helps the tire carcass to sustain load, simultaneously providing flexibility and an extra-wide footprint at very low pressure, resulting in very low soil compaction.

\* CupWheel technology by Galileo Wheel Ltd.

## SIZE

NEW	<b>VF 260/70R16*</b>	<b>110A8 (110B)</b>
	<b>VF 280/70R18</b>	<b>116A8 (116B)</b>
NEW	<b>VF 280/70R20</b>	<b>118A8 (118B)</b>
NEW	<b>VF 380/70R24*</b>	<b>137A8 (137B)</b>
NEW	<b>VF 420/70R28</b>	<b>145A8 (145B)</b>
	<b>VF 480/65R28</b>	<b>148A8 (148B)</b>

\* = in preparation

SIZE	Tread pattern	SW mm	OD mm	SLR mm	RC mm	SRI	Rim	Permitted Rims	Type	Tube
<b>VF 280/70R18</b> 116A8 (116B)	<b>PneuTrac®</b>	290	848	386	2510	400	9		TUBELESS	
<b>PRESSURE</b>										
<b>psi</b>		<b>9</b>		<b>12</b>		<b>14</b>		<b>17</b>		<b>23</b>
<b>bar</b>		<b>0,6</b>		<b>0,8</b>		<b>1,0</b>		<b>1,2</b>		<b>1,6</b>
<b>MAX. LOAD kg</b>										
<b>50</b>						915		1025		1140
40						915		1025		<b>1250</b>
30						935		1050		1165
20						955		1070		1190
10		760		880		1010		1130		1255

SIZE	Tread pattern	SW mm	OD mm	SLR mm	RC mm	SRI	Rim	Permitted Rims	Type	Tube
<b>VF 280/70R20</b> 118A8 (118B)	<b>PneuTrac®</b>	286	900	406	2690	450	9		TUBELESS	
<b>PRESSURE</b>										
<b>psi</b>		<b>9</b>		<b>12</b>		<b>14</b>		<b>17</b>		<b>23</b>
<b>bar</b>		<b>0,6</b>		<b>0,8</b>		<b>1,0</b>		<b>1,2</b>		<b>1,6</b>
<b>MAX. LOAD kg</b>										
<b>50</b>						965		1085		1205
40						965		1085		<b>1320</b>
30						985		1110		1230
20						1005		1130		1255
10		805		930		1065		1195		1330



SIZE	Tread pattern	SW mm	OD mm	SLR mm	RC mm	SRI	Rim	Permitted Rims	Type	Tube
<b>VF 420/70R28</b> 145A8 (145B)	<b>PneuTrac®</b>	419	1352	596	3970	650	W14		TUBELESS	
<b>PRESSURE</b>										
<b>psi</b>		<b>6</b>	<b>9</b>	<b>12</b>	<b>14</b>	<b>17</b>	<b>20</b>	<b>23</b>		
<b>bar</b>		<b>0,4</b>	<b>0,6</b>	<b>0,8</b>	<b>1,0</b>	<b>1,2</b>	<b>1,4</b>	<b>1,6</b>		
<b>MAX. LOAD kg</b>										
<b>50</b>					1855	2120	2380	2640	2900	
40					1855	2120	2380	2640	<b>2900</b>	
30					1895	2165	2430	2695	2960	
20					1930	2205	2480	2750	3020	
10		1470		1755	2045	2335	2620	2905	3190	

SIZE	Tread pattern	SW mm	OD mm	SLR mm	RC mm	SRI	Rim	Permitted Rims	Type	Tube
<b>VF 480/65R28</b> 148A8 (148B)	<b>PneuTrac®</b>	480	1340	595	3930	650	W16		TUBELESS	
<b>PRESSURE</b>										
<b>psi</b>		<b>6</b>	<b>9</b>	<b>12</b>	<b>14</b>	<b>17</b>	<b>20</b>	<b>23</b>		
<b>bar</b>		<b>0,4</b>	<b>0,6</b>	<b>0,8</b>	<b>1,0</b>	<b>1,2</b>	<b>1,4</b>	<b>1,6</b>		
<b>MAX. LOAD kg</b>										
<b>50</b>					2080	2365	2645	2900	3150	
40					2080	2365	2645	2900	<b>3150</b>	
30					2125	2415	2700	2960	3215	
20					2165	2460	2755	3020	3280	
10		1595		1945	2290	2605	2910	3190	3465	

For technical notes about pressure tables please refer to page 260.



# TM600



Range of standard-series tubeless tires with metric marking. The main feature of the TM600 range is the innovative tread design. The number and shape of the lugs, together with the rounded shoulder, guarantee the maximum grassy and crop respect.

## SIZE

<b>210/95R16</b>	<b>106A8 (106B)</b>	<b>(7.50R16)</b>
<b>210/95R18</b>	<b>108A8 (108B)</b>	<b>(7.50R18)</b>
<b>280/85R20</b>	<b>112A8 (109B)</b>	<b>(11.2R20)</b>
<b>320/85R20</b>	<b>119A8 (116B)</b>	<b>(12.4R20)</b>
<b>250/85R24</b>	<b>112A8 (109B)</b>	
<b>280/85R24</b>	<b>115A8 (112B)</b>	<b>(11.2R24)</b>
<b>320/85R24</b>	<b>122A8 (119B)</b>	<b>(12.4R24)</b>
<b>340/85R24</b>	• <b>125A8 (122B)</b>	<b>(13.6R24)</b>
<b>380/85R24</b>	<b>131A8 (128B)</b>	<b>(14.9R24)</b>
<b>420/85R24</b>	<b>137A8 (134B)</b>	<b>(16.9R24)</b>
<b>280/85R28</b>	<b>118A8 (115B)</b>	<b>(11.2R28)</b>
<b>320/85R28</b>	<b>124A8 (121B)</b>	<b>(12.4R28)</b>
<b>340/85R28</b>	• <b>127A8 (124B)</b>	<b>(13.6R28)</b>
<b>380/85R28</b>	<b>133A8 (130B)</b>	<b>(14.9R28)</b>
<b>420/85R28</b>	• <b>139A8 (136B)</b>	<b>(16.9R28)</b>
<b>380/85R30</b>	* <b>135A8 (135B)</b>	<b>(14.9R30)</b>
<b>420/85R30</b>	• <b>140A8 (137B)</b>	<b>(16.9R30)</b>
<b>420/90R30</b>	<b>147A8 (147B)</b>	
<b>460/85R30</b>	<b>145A8 (142B)</b>	<b>(18.4R30)</b>
<b>380/85R34</b>	<b>137A8 (137B)</b>	<b>(14.9R34)</b>
<b>380/85R34</b>	<b>142A8 (142B)</b>	<b>(14.9R34)</b>
<b>420/85R34</b>	<b>142A8 (139B)</b>	<b>(16.9R34)</b>
<b>420/85R34</b>	<b>147A8 (147B)</b>	

<b>460/85R34</b>	• <b>147A8 (144B)</b>	<b>(18.4R34)</b>
<b>320/85R38</b>	<b>129A8 (126B)</b>	<b>(12.4R38)</b>
<b>340/85R38</b>	<b>133A8 (130B)</b>	<b>(13.6R38)</b>
<b>380/80R38</b>	<b>142A8 (142B)</b>	
<b>380/85R38</b>	<b>144A8 (144B)</b>	<b>(14.9R38)</b>
<b>380/95R38</b>	* <b>147A8 (147B)</b>	
<b>400/75R38</b>	<b>138A8 (135B)</b>	<b>(15.5R38)</b>
<b>420/85R38</b>	<b>144A8 (141B)</b>	<b>(16.9R38)</b>
<b>420/85R38</b>	* <b>149A8 (149B)</b>	<b>(16.9R38)</b>
<b>460/85R38</b>	• <b>149A8 (146B)</b>	<b>(18.4R38)</b>
<b>480/80R38</b>	* <b>149A8 (149B)</b>	
<b>520/85R38</b>	• <b>155A8 (152B)</b>	<b>(20.8R38)</b>
<b>520/85R38</b>	* <b>155A8 (152B)</b>	<b>(20.8R38)</b>
<b>480/80R42</b>	• <b>151A8 (151B)</b>	<b>(18.4R42)</b>
<b>520/85R42</b>	• <b>157A8 (157B)</b>	<b>(20.8R42)</b>
<b>520/85R42</b>	<b>162A8 (162B)</b>	<b>(20.8R42)</b>
<b>480/80R46</b>	<b>158A8 (158B)</b>	<b>(18.4R46)</b>
<b>520/85R46</b>	<b>158A8 (158B)</b>	<b>(20.8R46)</b>
<b>480/80R50</b>	<b>159D</b>	
<b>480/95R50</b>	* <b>164A8 (164B)</b>	

- \* = ProgressiveTraction® version
- = available also in Heavy Duty version

# TM600 Rice



The 480/80R50 TM600 Rice is the ideal solution for application in paddy and muddy soils. The increased height of the tread compared to the R-1W version of the same size makes this tire extremely versatile in both very wet soil conditions and in light road applications.

## SIZE

<b>480/80R50</b>	* <b>159A8 (159B)</b>	<b>Rice</b>
------------------	-----------------------	-------------

- \* = ProgressiveTraction® version

SIZE	Tread pattern	SW mm	OD mm	SLR mm	RC mm	SRI	Rim	Permitted Rims	Type	Tube
<b>210/95R16</b> 106A8 (106B) (7.50R16)	<b>TM600</b>	210	800	363	2415	390	W7	W6 - 5.50F	TUBELESS	

**PRESSURE**

**H**

<b>psi</b>	<b>14</b>	<b>17</b>	<b>20</b>	<b>23</b>	<b>29</b>	<b>35</b>	<b>41</b>	<b>42</b>	<b>43</b>
<b>bar</b>	<b>1,0</b>	<b>1,2</b>	<b>1,4</b>	<b>1,6</b>	<b>2,0</b>	<b>2,4</b>	<b>2,8</b>	<b>2,9</b>	<b>3,0</b>

**MAX. LOAD kg**

50 S	590	665	745	820	895	950			
<b>40 S</b>	590	665	745	820	895	<b>950</b>			
30 S	635	715	800	880	960	1020			
10 LT S	805	905	1015	1120	1220	1295	1400	1425	1450
10 HT S	635	715	800	880	960	1020			

SIZE	Tread pattern	SW mm	OD mm	SLR mm	RC mm	SRI	Rim	Permitted Rims	Type	Tube
<b>210/95R18</b> 108A8 (108B) (7.50R18)	<b>TM600</b>	210	855	391	2555	410	W7	W6 - 5.50F	TUBELESS	

**PRESSURE**

**H**

<b>psi</b>	<b>14</b>	<b>17</b>	<b>20</b>	<b>23</b>	<b>29</b>	<b>35</b>	<b>41</b>	<b>42</b>	<b>43</b>
<b>bar</b>	<b>1,0</b>	<b>1,2</b>	<b>1,4</b>	<b>1,6</b>	<b>2,0</b>	<b>2,4</b>	<b>2,8</b>	<b>2,9</b>	<b>3,0</b>

**MAX. LOAD kg**

50 S	620	700	780	860	940	1000			
<b>40 S</b>	620	700	780	860	940	<b>1000</b>			
30 S	665	750	835	925	1010	1070			
10 LT S	845	955	1065	1170	1280	1360	1470	1500	1525
10 HT S	665	750	835	925	1010	1070			

SIZE	Tread pattern	SW mm	OD mm	SLR mm	RC mm	SRI	Rim	Permitted Rims	Type	Tube
<b>280/85R20</b> 112A8 (109B) (11.2R20)	<b>TM600</b>	295	985	450	2955	475	W10	W9 - W8 - DW10	TUBELESS	11.2-20 TR218

**PRESSURE**

**H**

<b>psi</b>	<b>6</b>	<b>9</b>	<b>12</b>	<b>14</b>	<b>17</b>	<b>20</b>	<b>23</b>	<b>26</b>	<b>28</b>	<b>30</b>
<b>bar</b>	<b>0,4</b>	<b>0,6</b>	<b>0,8</b>	<b>1,0</b>	<b>1,2</b>	<b>1,4</b>	<b>1,6</b>	<b>1,8</b>	<b>1,9</b>	<b>2,1</b>

**MAX. LOAD kg**

50 S	680	750	815	885	955	1030				
<b>40 S</b>	745	820	895	970	1045	<b>1120</b>				
30 S	800	880	960	1040	1120	1200				
10 LT S	895	1000	1105	1210	1315	1420	1525	1630	1680	1905
10 HT S	800	880	960	1040	1120	1200				

**TM600 - TM600 Rice**

Radial tire for tractors, sprayers and spreaders



SIZE	Tread pattern	SW mm	OD mm	SLR mm	RC mm	SRI	Rim	Permitted Rims	Type	Tube
<b>320/85R20</b> 119A8 (116B) (12.4R20)	<b>TM600</b>	329	1052	470	3160	500	W11	W10 - W9 - DW11	TUBELESS	11.2-20 TR218

**PRESSURE**

**H**

<b>psi</b>	<b>6</b>	<b>9</b>	<b>12</b>	<b>14</b>	<b>17</b>	<b>20</b>	<b>23</b>	<b>26</b>	<b>28</b>	<b>30</b>
<b>bar</b>	<b>0,4</b>	<b>0,6</b>	<b>0,8</b>	<b>1,0</b>	<b>1,2</b>	<b>1,4</b>	<b>1,6</b>	<b>1,8</b>	<b>1,9</b>	<b>2,1</b>

**MAX. LOAD kg**

50 S			825	910	995	1075	1160	1250			
<b>40 S</b>			905	1000	1090	1180	1270	<b>1360</b>			
30 S			970	1070	1170	1265	1360	1460			
10 LT S		1105	1230	1355	1480	1605	1730	1855	1980	2040	2315
10 HT S			970	1070	1170	1265	1360	1460			

SIZE	Tread pattern	SW mm	OD mm	SLR mm	RC mm	SRI	Rim	Permitted Rims	Type	Tube
<b>250/85R24</b> 112A8 (109B)	<b>TM600</b>	245	1035	465	3115	500	W8	W7 - W9	Tubeless	9.5R24 TR218

**PRESSURE**

**H**

<b>psi</b>	<b>9</b>	<b>12</b>	<b>14</b>	<b>17</b>	<b>20</b>	<b>23</b>	<b>29</b>	<b>32</b>	<b>35</b>	<b>38</b>
<b>bar</b>	<b>0,6</b>	<b>0,8</b>	<b>1,0</b>	<b>1,2</b>	<b>1,4</b>	<b>1,6</b>	<b>2,0</b>	<b>2,2</b>	<b>2,4</b>	<b>2,6</b>

**MAX. LOAD kg**

50 S		510	585	675	760	845	935	1030			
<b>40 S</b>		560	645	740	835	930	1025	<b>1120</b>			
30 S		600	690	790	895	995	1100	1200			
10 LT S		760	870	1000	1125	1255	1385	1515	1605	1680	1905
10 HT S		600	690	790	895	995	1100	1200			

SIZE	Tread pattern	SW mm	OD mm	SLR mm	RC mm	SRI	Rim	Permitted Rims	Type	Tube
<b>280/85R24</b> 115A8 (112B) (11.2R24)	<b>TM600</b>	292	1086	494	3276	525	W10	W9 - W8 - DW10	TUBELESS	11.2-24 TR218

**PRESSURE**

**H**

<b>psi</b>	<b>6</b>	<b>9</b>	<b>12</b>	<b>14</b>	<b>17</b>	<b>20</b>	<b>23</b>	<b>26</b>	<b>28</b>	<b>30</b>
<b>bar</b>	<b>0,4</b>	<b>0,6</b>	<b>0,8</b>	<b>1,0</b>	<b>1,2</b>	<b>1,4</b>	<b>1,6</b>	<b>1,8</b>	<b>1,9</b>	<b>2,1</b>

**MAX. LOAD kg**

50 S			740	815	890	965	1035	1120			
<b>40 S</b>			810	895	975	1055	1135	<b>1215</b>			
30 S			870	960	1045	1130	1215	1305			
10 LT S		980	1095	1210	1325	1440	1550	1660	1770	1825	2070
10 HT S			870	960	1045	1130	1215	1305			

SIZE	Tread pattern	SW mm	OD mm	SLR mm	RC mm	SRI	Rim	Permitted Rims	Type	Tube
<b>320/85R24</b> 122A8 (119B) (12.4R24)	<b>TM600</b>	329	1154	515	3465	550	W11	W10 - W9 - DW10 DW11	TUBELESS	12.4-24 13.6-24 TR218

#### PRESSURE

**H**

psi	<b>6</b>	<b>9</b>	<b>12</b>	<b>14</b>	<b>17</b>	<b>20</b>	<b>23</b>	<b>26</b>	<b>28</b>	<b>30</b>
bar	<b>0,4</b>	<b>0,6</b>	<b>0,8</b>	<b>1,0</b>	<b>1,2</b>	<b>1,4</b>	<b>1,6</b>	<b>1,8</b>	<b>1,9</b>	<b>2,1</b>

#### MAX. LOAD kg

50 S			910	1005	1095	1185	1275	1360			
<b>40 S</b>			1000	1100	1200	1300	1400	<b>1500</b>			
30 S			1070	1180	1285	1395	1500	1605			
10 LT S		1200	1340	1480	1620	1760	1900	2040	2180	2250	2550
10 HT S			1070	1180	1285	1395	1500	1605			

SIZE	Tread pattern	SW mm	OD mm	SLR mm	RC mm	SRI	Rim	Permitted Rims	Type	Tube
<b>340/85R24</b> 125A8 (122B) (13.6R24)	<b>TM600</b>	353	1188	540	3547	575	W12	W11 - DW11 - DW12	TUBELESS	13.6-24 14.9-24 TR218

#### PRESSURE

**H**

psi	<b>6</b>	<b>9</b>	<b>12</b>	<b>14</b>	<b>17</b>	<b>20</b>	<b>23</b>	<b>26</b>	<b>28</b>	<b>30</b>
bar	<b>0,4</b>	<b>0,6</b>	<b>0,8</b>	<b>1,0</b>	<b>1,2</b>	<b>1,4</b>	<b>1,6</b>	<b>1,8</b>	<b>1,9</b>	<b>2,1</b>

#### MAX. LOAD kg

50 S			1000	1105	1205	1305	1405	1500			
<b>40 S</b>			1095	1210	1320	1430	1540	<b>1650</b>			
30 S			1175	1295	1415	1535	1650	1770			
10 LT S		1320	1475	1630	1785	1940	2095	2250	2400	2475	2805
10 HT S			1175	1295	1415	1535	1650	1770			

\* Available also in Heavy Duty version

SIZE	Tread pattern	SW mm	OD mm	SLR mm	RC mm	SRI	Rim	Permitted Rims	Type	Tube
<b>380/85R24</b> 131A8 (128B) (14.9R24)	<b>TM600</b>	390	1256	560	3750	600	W13	W12 - W11 - DW11 DW12 - DW13	TUBELESS	14.9-24 16.9-24 TR218

#### PRESSURE

**H**

psi	<b>6</b>	<b>9</b>	<b>12</b>	<b>14</b>	<b>17</b>	<b>20</b>	<b>23</b>	<b>26</b>	<b>28</b>	<b>30</b>
bar	<b>0,4</b>	<b>0,6</b>	<b>0,8</b>	<b>1,0</b>	<b>1,2</b>	<b>1,4</b>	<b>1,6</b>	<b>1,8</b>	<b>1,9</b>	<b>2,1</b>

#### MAX. LOAD kg

50 S			1170	1295	1420	1540	1660	1800			
<b>40 S</b>			1285	1420	1555	1690	1820	<b>1950</b>			
30 S			1375	1520	1665	1810	1950	2090			
10 LT S		1575	1755	1935	2115	2295	2475	2655	2835	2925	3315
10 HT S			1375	1520	1665	1810	1950	2090			

### TM600 - TM600 Rice

Radial tire for tractors, sprayers and spreaders



SIZE	Tread pattern	SW mm	OD mm	SLR mm	RC mm	SRI	Rim	Permitted Rims	Type	Tube
<b>420/85R24</b> 137A8 (134B) (16.9R24)	<b>TM600</b>	438	1324	590	3970	625	W15L	W14L - DW14L DW15L	TUBELESS	16.9-24 TR218

**PRESSURE**

**H**

<b>psi</b>	<b>6</b>	<b>9</b>	<b>12</b>	<b>14</b>	<b>17</b>	<b>20</b>	<b>23</b>	<b>26</b>	<b>28</b>	<b>30</b>
<b>bar</b>	<b>0,4</b>	<b>0,6</b>	<b>0,8</b>	<b>1,0</b>	<b>1,2</b>	<b>1,4</b>	<b>1,6</b>	<b>1,8</b>	<b>1,9</b>	<b>2,1</b>

**MAX. LOAD kg**

50 S				1385	1530	1670	1815	1955	2120			
<b>40 S</b>				1520	1680	1835	1990	2145	<b>2300</b>			
30 S				1630	1800	1965	2130	2300	2465			
10 LT S		1840		2055	2270	2485	2700	2915	3130	3345	3450	3910
10 HT S				1630	1800	1965	2130	2300	2465			

SIZE	Tread pattern	SW mm	OD mm	SLR mm	RC mm	SRI	Rim	Permitted Rims	Type	Tube
<b>280/85R28</b> 118A8 (115B) (11.2R28)	<b>TM600</b>	292	1187	542	3580	575	W10	W9 - DW10	TUBELESS	11.2-28 12.4-28 TR218

**PRESSURE**

**H**

<b>psi</b>	<b>6</b>	<b>9</b>	<b>12</b>	<b>14</b>	<b>17</b>	<b>20</b>	<b>23</b>	<b>26</b>	<b>28</b>	<b>30</b>
<b>bar</b>	<b>0,4</b>	<b>0,6</b>	<b>0,8</b>	<b>1,0</b>	<b>1,2</b>	<b>1,4</b>	<b>1,6</b>	<b>1,8</b>	<b>1,9</b>	<b>2,1</b>

**MAX. LOAD kg**

50 S				795	875	960	1040	1120	1215			
<b>40 S</b>				870	960	1050	1140	1230	<b>1320</b>			
30 S				935	1030	1125	1220	1320	1415			
10 LT S		1065		1190	1315	1440	1560	1680	1800	1920	1980	2245
10 HT S				935	1030	1125	1220	1320	1415			

SIZE	Tread pattern	SW mm	OD mm	SLR mm	RC mm	SRI	Rim	Permitted Rims	Type	Tube
<b>320/85R28</b> 124A8 (121B) (12.4R28)	<b>TM600</b>	329	1255	566	3796	600	W11	W10 - W9 - DW10 DW11	TUBELESS	12.4-28 TR218

**PRESSURE**

**H**

<b>psi</b>	<b>6</b>	<b>9</b>	<b>12</b>	<b>14</b>	<b>17</b>	<b>20</b>	<b>23</b>	<b>26</b>	<b>28</b>	<b>30</b>
<b>bar</b>	<b>0,4</b>	<b>0,6</b>	<b>0,8</b>	<b>1,0</b>	<b>1,2</b>	<b>1,4</b>	<b>1,6</b>	<b>1,8</b>	<b>1,9</b>	<b>2,1</b>

**MAX. LOAD kg**

50 S				960	1060	1160	1260	1360	1450			
<b>40 S</b>				1050	1160	1270	1380	1490	<b>1600</b>			
30 S				1125	1245	1360	1480	1595	1715			
10 LT S		1275		1425	1575	1725	1875	2025	2175	2325	2400	2720
10 HT S				1125	1245	1360	1480	1595	1715			

SIZE	Tread pattern	SW mm	OD mm	SLR mm	RC mm	SRI	Rim	Permitted Rims	Type	Tube
<b>340/85R28</b> 127A8 (124B) (13.6R28)	<b>TM600</b>	353	1289	595	3885	625	W12	W11 - DW11 - DW12	TUBELESS	13.6-28 12.4-28 TR218

**PRESSURE**

	psi	6	9	12	14	17	20	23	26	28	30
	bar	0,4	0,6	0,8	1,0	1,2	1,4	1,6	1,8	1,9	2,1

**MAX. LOAD kg**

50 S				1050	1160	1265	1375	1485	1600			
<b>40 S</b>				1150	1270	1390	1510	1630	<b>1750</b>			
30 S				1235	1360	1490	1620	1745	1875			
10 LT S			1405	1570	1735	1900	2065	2225	2385	2545	2625	2975
10 HT S				1235	1360	1490	1620	1745	1875			

\* Available also in Heavy Duty version

SIZE	Tread pattern	SW mm	OD mm	SLR mm	RC mm	SRI	Rim	Permitted Rims	Type	Tube
<b>380/85R28</b> 133A8 (130B) (14.9R28)	<b>TM600</b>	390	1357	615	4085	650	W13	W12 - W11 - DW11 DW12 - DW13	TUBELESS	14.9-28 16.9-28 TR218

**PRESSURE**

	psi	6	9	12	14	17	20	23	26	28	30
	bar	0,4	0,6	0,8	1,0	1,2	1,4	1,6	1,8	1,9	2,1

**MAX. LOAD kg**

50 S				1240	1365	1495	1620	1750	1900			
<b>40 S</b>				1360	1500	1640	1780	1920	<b>2060</b>			
30 S				1460	1605	1755	1905	2055	2205			
10 LT S			1660	1855	2045	2235	2425	2615	2805	2995	3090	3505
10 HT S				1460	1605	1755	1905	2055	2205			

SIZE	Tread pattern	SW mm	OD mm	SLR mm	RC mm	SRI	Rim	Permitted Rims	Type	Tube
<b>420/85R28</b> 139A8 (136B) (16.9R28)	<b>TM600</b>	438	1425	635	4290	675	W15L	W14L - DW14L DW15L	TUBELESS	16.9-28 TR218

**PRESSURE**

	psi	6	9	12	14	17	20	23	26	28	30
	bar	0,4	0,6	0,8	1,0	1,2	1,4	1,6	1,8	1,9	2,1

**MAX. LOAD kg**

50 S				1465	1615	1765	1915	2065	2240			
<b>40 S</b>				1605	1770	1935	2100	2265	<b>2430</b>			
30 S				1720	1895	2075	2250	2425	2605			
10 LT S			1955	2185	2410	2635	2860	3085	3310	3535	3645	4135
10 HT S				1720	1895	2075	2250	2425	2605			

\* Available also in Heavy Duty version

**TM600 - TM600 Rice**

Radial tire for tractors, sprayers and spreaders



SIZE	Tread pattern	SW mm	OD mm	SLR mm	RC mm	SRI	Rim	Permitted Rims	Type	Tube	
<b>380/85R30</b> 135A8 (135B) (14.9R30)	<b>TM600</b>	390	1408	635	4238	675	W13	W12- W11 - DW11 DW12 - DW13	TUBELESS	14.9-30 TR218	
With ProgressiveTraction® profile											
<b>PRESSURE</b>										<b>H</b>	
<b>psi</b>		<b>6</b>	<b>9</b>	<b>12</b>	<b>14</b>	<b>17</b>	<b>20</b>	<b>23</b>	<b>26</b>	<b>28</b>	<b>30</b>
<b>bar</b>		<b>0,4</b>	<b>0,6</b>	<b>0,8</b>	<b>1,0</b>	<b>1,2</b>	<b>1,4</b>	<b>1,6</b>	<b>1,8</b>	<b>1,9</b>	<b>2,1</b>
<b>MAX. LOAD kg</b>											
50 S				1430	1580	1730	1880	2030	2180		
<b>40 S</b>				1430	1580	1730	1880	2030	<b>2180</b>		
30 S				1535	1695	1855	2015	2175	2335		
10 LT S			1745	1950	2155	2360	2565	2770	2970	3170	3270
10 HT S				1535	1695	1855	2015	2175	2335		

SIZE	Tread pattern	SW mm	OD mm	SLR mm	RC mm	SRI	Rim	Permitted Rims	Type	Tube	
<b>420/85R30</b> 140A8 (137B) (16.9R30)	<b>TM600</b>	438	1475	660	4455	700	W15L	W14L - DW14L DW15L	TUBELESS	16.9-30 18.4-30 TR218	
<b>PRESSURE</b>										<b>H</b>	
<b>psi</b>		<b>6</b>	<b>9</b>	<b>12</b>	<b>14</b>	<b>17</b>	<b>20</b>	<b>23</b>	<b>26</b>	<b>28</b>	<b>30</b>
<b>bar</b>		<b>0,4</b>	<b>0,6</b>	<b>0,8</b>	<b>1,0</b>	<b>1,2</b>	<b>1,4</b>	<b>1,6</b>	<b>1,8</b>	<b>1,9</b>	<b>2,1</b>
<b>MAX. LOAD kg</b>											
50 S				1505	1660	1815	1970	2125	2300		
<b>40 S</b>				1650	1820	1990	2160	2330	<b>2500</b>		
30 S				1770	1950	2130	2315	2495	2675		
10 LT S			2000	2235	2470	2705	2940	3175	3405	3635	3750
10 HT S				1770	1950	2130	2315	2495	2675		

\* Available also in Heavy Duty version

SIZE	Tread pattern	SW mm	OD mm	SLR mm	RC mm	SRI	Rim	Permitted Rims	Type	Tube		
<b>420/90R30</b> 147A8 (147B)	<b>TM600</b>	435	1518	691	4580	700	DW13	W13 - W14L DW14L	TUBELESS	18.4-30 TR218		
<b>PRESSURE</b>										<b>H</b>		
<b>psi</b>		<b>9</b>	<b>12</b>	<b>14</b>	<b>17</b>	<b>20</b>	<b>23</b>	<b>29</b>	<b>35</b>	<b>41</b>	<b>42</b>	<b>43</b>
<b>bar</b>		<b>0,6</b>	<b>0,8</b>	<b>1,0</b>	<b>1,2</b>	<b>1,4</b>	<b>1,6</b>	<b>2,0</b>	<b>2,4</b>	<b>2,8</b>	<b>2,9</b>	<b>3,0</b>
<b>MAX. LOAD kg</b>												
50 S			1450	1665	1910	2155	2400	2645	2860	3075		
<b>40 S</b>			1450	1665	1910	2155	2400	2645	2860	<b>3075</b>		
30 S			1550	1780	2040	2305	2570	2830	3060	3295		
10 LT S			1950	2240	2570	2900	3235	3565	3855	4145	4520	4615
10 HT S			1550	1780	2040	2305	2570	2830	3060	3295		



SIZE	Tread pattern	SW mm	OD mm	SLR mm	RC mm	SRI	Rim	Permitted Rims	Type	Tube			
<b>460/85R30</b> 145A8 (142B) (18.4R30)	<b>TM600</b>	475	1544	691	4678	725	W16L	W15L - DW15L DW16L	TUBELESS	18.4-30 TR218			
<b>PRESSURE</b>										<b>H</b>			
		<b>psi</b>		<b>6</b>	<b>9</b>	<b>12</b>	<b>14</b>	<b>17</b>	<b>20</b>	<b>23</b>	<b>26</b>	<b>28</b>	<b>30</b>
		<b>bar</b>		<b>0,4</b>	<b>0,6</b>	<b>0,8</b>	<b>1,0</b>	<b>1,2</b>	<b>1,4</b>	<b>1,6</b>	<b>1,8</b>	<b>1,9</b>	<b>2,1</b>
<b>MAX. LOAD kg</b>													
		50 S			1730	1915	2095	2275	2460	2650			
		<b>40 S</b>			1900	2100	2300	2500	2700	<b>2900</b>			
		30 S			2035	2250	2465	2675	2890	3105			
		10 LT S		2325	2595	2865	3135	3405	3675	3945	4215	4350	4930
		10 HT S			2035	2250	2465	2675	2890	3105			

SIZE	Tread pattern	SW mm	OD mm	SLR mm	RC mm	SRI	Rim	Permitted Rims	Type	Tube			
<b>380/85R34</b> 137A8 (137B) (14.9R34)	<b>TM600</b>	390	1513	683	4574	725	W12	W13	TUBELESS	16.9-34 TR218			
<b>PRESSURE</b>										<b>H</b>			
		<b>psi</b>		<b>6</b>	<b>9</b>	<b>12</b>	<b>14</b>	<b>17</b>	<b>20</b>	<b>23</b>	<b>26</b>	<b>28</b>	<b>30</b>
		<b>bar</b>		<b>0,4</b>	<b>0,6</b>	<b>0,8</b>	<b>1,0</b>	<b>1,2</b>	<b>1,4</b>	<b>1,6</b>	<b>1,8</b>	<b>1,9</b>	<b>2,1</b>
<b>MAX. LOAD kg</b>													
		50 S			1515	1670	1830	1990	2145	2300			
		<b>40 S</b>			1515	1670	1830	1990	2145	<b>2300</b>			
		30 S			1620	1790	1960	2130	2295	2465			
		10 LT S		1850	2060	2275	2490	2705	2920	3130	3345	3450	3910
		10 HT S			1620	1790	1960	2130	2295	2465			

SIZE	Tread pattern	SW mm	OD mm	SLR mm	RC mm	SRI	Rim	Permitted Rims	Type	Tube				
<b>380/85R34</b> 142A8 (142B) (14.9R34)	<b>TM600</b>	390	1515	693	4565	725	W12	W13	TUBELESS					
<b>PRESSURE</b>										<b>H</b>				
		<b>psi</b>		<b>9</b>	<b>12</b>	<b>14</b>	<b>17</b>	<b>20</b>	<b>23</b>	<b>29</b>	<b>35</b>	<b>41</b>	<b>42</b>	<b>43</b>
		<b>bar</b>		<b>0,6</b>	<b>0,8</b>	<b>1,0</b>	<b>1,2</b>	<b>1,4</b>	<b>1,6</b>	<b>2,0</b>	<b>2,4</b>	<b>2,8</b>	<b>2,9</b>	<b>3,0</b>
<b>MAX. LOAD kg</b>														
		50 S		1250	1435	1645	1855	2070	2280	2495	2650			
		<b>40 S</b>		1250	1435	1645	1855	2070	2280	2495	<b>2650</b>			
		30 S		1340	1540	1765	1985	2215	2440	2670	2840			
		10 LT S		1690	1940	2225	2505	2795	3080	3370	3580	3900	4025	4510
		10 HT S		1340	1540	1765	1985	2215	2440	2670	2840			

### TM600 - TM600 Rice

Radial tire for tractors, sprayers and spreaders



SIZE	Tread pattern	SW mm	OD mm	SLR mm	RC mm	SRI	Rim	Permitted Rims	Type	Tube		
<b>420/85R34</b> 142A8 (139B) (16.9R34)	<b>TM600</b>	438	1578	715	4745	750	W15L	W14L - DW14L DW15L	TUBELESS	16.9-34 TR218		
<b>PRESSURE</b>										<b>H</b>		
psi			<b>6</b>	<b>9</b>	<b>12</b>	<b>14</b>	<b>17</b>	<b>20</b>	<b>23</b>	<b>26</b>	<b>28</b>	<b>30</b>
bar			<b>0,4</b>	<b>0,6</b>	<b>0,8</b>	<b>1,0</b>	<b>1,2</b>	<b>1,4</b>	<b>1,6</b>	<b>1,8</b>	<b>1,9</b>	<b>2,1</b>
<b>MAX. LOAD kg</b>												
50 S				1595	1760	1925	2085	2250	2430			
<b>40 S</b>				1750	1930	2110	2290	2470	<b>2650</b>			
30 S				1875	2070	2260	2455	2645	2840			
10 LT S			2125	2375	2625	2875	3120	3365	3610	3855	3975	4505
10 HT S			1875	2070	2260	2455	2645	2840				

SIZE	Tread pattern	SW mm	OD mm	SLR mm	RC mm	SRI	Rim	Permitted Rims	Type	Tube			
<b>420/85R34</b> 147A8 (147B) 16.9R34	<b>TM600</b>	445	1575	725	4735	750	W15L	W14L - DW14L DW15L	TUBELESS	16.9-34 TR218			
<b>PRESSURE</b>										<b>H</b>			
psi			<b>9</b>	<b>12</b>	<b>14</b>	<b>17</b>	<b>20</b>	<b>23</b>	<b>29</b>	<b>35</b>	<b>41</b>	<b>42</b>	<b>43</b>
bar			<b>0,6</b>	<b>0,8</b>	<b>1,0</b>	<b>1,2</b>	<b>1,4</b>	<b>1,6</b>	<b>2,0</b>	<b>2,4</b>	<b>2,8</b>	<b>2,9</b>	<b>3,0</b>
<b>MAX. LOAD kg</b>													
50 S			1325	1665	1910	2155	2400	2645	2860	3075			
<b>40 S</b>			1325	1665	1910	2155	2400	2645	2860	<b>3075</b>			
30 S			1415	1780	2040	2305	2570	2830	3060	3295			
10 LT S			1800	2260	2595	2930	3265	3600	3890	4185	4525	4615	5230
10 HT S			1415	1780	2040	2305	2570	2830	3060	3295			

SIZE	Tread pattern	SW mm	OD mm	SLR mm	RC mm	SRI	Rim	Permitted Rims	Type	Tube		
<b>460/85R34</b> 147A8 (144B) 18.4R34	<b>TM600</b>	475	1646	745	4945	775	W16L	W15L - DW15L - DW16L	TUBELESS	18.4-34 16.9-34 TR218		
<b>PRESSURE</b>										<b>H</b>		
psi			<b>6</b>	<b>9</b>	<b>12</b>	<b>14</b>	<b>17</b>	<b>20</b>	<b>23</b>	<b>26</b>	<b>28</b>	<b>30</b>
bar			<b>0,4</b>	<b>0,6</b>	<b>0,8</b>	<b>1,0</b>	<b>1,2</b>	<b>1,4</b>	<b>1,6</b>	<b>1,8</b>	<b>1,9</b>	<b>2,1</b>
<b>MAX. LOAD kg</b>												
50 S				1845	2035	2225	2420	2610	2800			
<b>40 S</b>				2025	2235	2445	2655	2865	<b>3075</b>			
30 S				2170	2395	2620	2845	3070	3295			
10 LT S			2465	2755	3045	3335	3620	3905	4190	4475	4615	5230
10 HT S			2170	2395	2620	2845	3070	3295				

\* Available also in Heavy Duty version

SIZE	Tread pattern	SW mm	OD mm	SLR mm	RC mm	SRI	Rim	Permitted Rims	Type	Tube
<b>320/85R38</b> 129A8 (126B) (12.4R38)	<b>TM600</b>	325	1520	690	4605	725	W11	W10 - W9 - DW10 DW11	TUBELESS	12.4-38 16.9-38 TR218

**PRESSURE**

	psi	6	9	12	14	17	20	23	26	28	30
bar		0,4	0,6	0,8	1,0	1,2	1,4	1,6	1,8	1,9	2,1

**MAX. LOAD kg**

50 S				1105	1220	1340	1455	1570	1700			
<b>40 S</b>				1215	1340	1470	1595	1725	<b>1850</b>			
30 S				1300	1435	1570	1710	1845	1980			
10 LT S		1660	1650	1825	1995	2170	2345	2515	2690	2775	3145	
10 HT S			1300	1435	1570	1710	1845	1980				

SIZE	Tread pattern	SW mm	OD mm	SLR mm	RC mm	SRI	Rim	Permitted Rims	Type	Tube
<b>340/85R38</b> 133A8 (130B) (13.6R38)	<b>TM600</b>	353	1543	710	4665	750	W12	W11 - DW11 DW12	TUBELESS	13.6-38 16.9-38 TR218

**PRESSURE**

	psi	6	9	12	14	17	20	23	26	28	30
bar		0,4	0,6	0,8	1,0	1,2	1,4	1,6	1,8	1,9	2,1

**MAX. LOAD kg**

50 S				1240	1365	1495	1620	1750	1900			
<b>40 S</b>				1360	1500	1640	1780	1920	<b>2060</b>			
30 S				1460	1605	1755	1905	2055	2205			
10 LT S		1660	1855	2045	2235	2425	2615	2805	2995	3090	3505	
10 HT S			1460	1605	1755	1905	2055	2205				

SIZE	Tread pattern	SW mm	OD mm	SLR mm	RC mm	SRI	Rim	Permitted Rims	Type	Tube
<b>380/80R38</b> 142A8 (142B)	<b>TM600</b>	375	1575	724	4765	750	W12	W11 - W13 - DW11 DW12 - DW13	TUBELESS	14.9-38 16.9-38 TR218

**PRESSURE**

	psi	9	12	14	17	20	23	29	35	41	42	43
bar		0,6	0,8	1,0	1,2	1,4	1,6	2,0	2,4	2,8	2,9	3,0

**MAX. LOAD kg**

50 S			1250	1435	1645	1855	2070	2280	2465	2650		
<b>40 S</b>			1250	1435	1645	1855	2070	2280	2465	<b>2650</b>		
30 S			1335	1535	1760	1985	2215	2440	2640	2840		
10 LT S		1680	1930	2215	2500	2785	3070	3320	3570	3895	3975	4505
10 HT S			1335	1535	1760	1985	2215	2440	2640	2840		

**TM600 - TM600 Rice**

Radial tire for tractors, sprayers and spreaders



SIZE	Tread pattern	SW mm	OD mm	SLR mm	RC mm	SRI	Rim	Permitted Rims	Type	Tube			
<b>380/85R38</b> 144A8 (144B) (14.9R38)	<b>TM600</b>	400	1610	730	4900	775	W13	W11 - W12 DW11-DW12-DW13	TUBELESS	16.9-38 TR218			
<b>PRESSURE</b>										<b>H</b>			
<b>psi</b>			<b>9</b>	<b>12</b>	<b>14</b>	<b>17</b>	<b>20</b>	<b>23</b>	<b>29</b>	<b>35</b>	<b>41</b>	<b>42</b>	<b>43</b>
<b>bar</b>			<b>0,6</b>	<b>0,8</b>	<b>1,0</b>	<b>1,2</b>	<b>1,4</b>	<b>1,6</b>	<b>2,0</b>	<b>2,4</b>	<b>2,8</b>	<b>2,9</b>	<b>3,0</b>
<b>MAX. LOAD kg</b>													
50 S			1320	1515	1740	1960	2185	2410	2605	2800			
<b>40 S</b>			1320	1515	1740	1960	2185	2410	2605	<b>2800</b>			
30 S			1410	1620	1860	2100	2340	2580	2790	3000			
10 LT S			1775	2040	2340	2645	2945	3245	3510	3775	4115	4200	4760
10 HT S			1410	1620	1860	2100	2340	2580	2790	3000			

SIZE	Tread pattern	SW mm	OD mm	SLR mm	RC mm	SRI	Rim	Permitted Rims	Type	Tube			
<b>380/95R38</b> 147A8	<b>TM600</b>	390	1674	762	5020	800	W12	W13	TUBELESS				
<b>With ProgressiveTraction® profile</b>													
<b>PRESSURE</b>										<b>H</b>			
<b>psi</b>			<b>9</b>	<b>12</b>	<b>14</b>	<b>17</b>	<b>20</b>	<b>23</b>	<b>29</b>	<b>35</b>	<b>41</b>	<b>42</b>	<b>43</b>
<b>bar</b>			<b>0,6</b>	<b>0,8</b>	<b>1,0</b>	<b>1,2</b>	<b>1,4</b>	<b>1,6</b>	<b>2,0</b>	<b>2,4</b>	<b>2,8</b>	<b>2,9</b>	<b>3,0</b>
<b>MAX. LOAD kg</b>													
50 S			1450	1665	1910	2155	2400	2645	2895	3075			
<b>40 S</b>			1450	1665	1910	2155	2400	2645	2895	<b>3075</b>			
30 S			1555	1785	2045	2310	2570	2835	3100	3295			
10 LT S			1960	2250	2580	2910	3240	3575	3910	4155	4525	4675	5235
10 HT S			1555	1785	2045	2310	2570	2835	3100	3295			

SIZE	Tread pattern	SW mm	OD mm	SLR mm	RC mm	SRI	Rim	Permitted Rims	Type	Tube		
<b>400/75R38</b> 138A8 (135B) (15.5R38)	<b>TM600</b>	395	1565	707	4670	750	DW14L	W12 - W14L	TUBELESS			
<b>PRESSURE</b>										<b>H</b>		
<b>psi</b>			<b>6</b>	<b>9</b>	<b>12</b>	<b>14</b>	<b>17</b>	<b>20</b>	<b>23</b>	<b>26</b>	<b>28</b>	<b>30</b>
<b>bar</b>			<b>0,4</b>	<b>0,6</b>	<b>0,8</b>	<b>1,0</b>	<b>1,2</b>	<b>1,4</b>	<b>1,6</b>	<b>1,8</b>	<b>1,9</b>	<b>2,1</b>
<b>MAX. LOAD kg</b>												
50 S				1435	1585	1735	1885	2035	2180			
<b>40 S</b>				1555	1715	1880	2040	2200	<b>2360</b>			
30 S				1660	1835	2010	2185	2355	2530			
10 LT S			1895	2110	2335	2555	2775	2995	3210	3430	3540	4015
10 HT S				1660	1835	2010	2185	2355	2530			

SIZE	Tread pattern	SW mm	OD mm	SLR mm	RC mm	SRI	Rim	Permitted Rims	Type	Tube
<b>420/85R38</b> 144A8 (141B) (16.9R38)	<b>TM600</b>	438	1679	760	5060	800	W15L	W14L - DW14L DW15L	TUBELESS	16.9-38 TR218

**PRESSURE**

**H**

psi	<b>6</b>	<b>9</b>	<b>12</b>	<b>14</b>	<b>17</b>	<b>20</b>	<b>23</b>	<b>26</b>	<b>28</b>	<b>30</b>
bar	<b>0,4</b>	<b>0,6</b>	<b>0,8</b>	<b>1,0</b>	<b>1,2</b>	<b>1,4</b>	<b>1,6</b>	<b>1,8</b>	<b>1,9</b>	<b>2,1</b>

**MAX. LOAD kg**

50 S			1685	1860	2030	2205	2380	2575			
<b>40 S</b>			1850	2040	2230	2420	2610	<b>2800</b>			
30 S			1980	2185	2390	2590	2795	3000			
10 LT S		2250	2510	2770	3030	3290	3550	3810	4070	4200	4760
10 HT S			1980	2185	2390	2590	2795	3000			

SIZE	Tread pattern	SW mm	OD mm	SLR mm	RC mm	SRI	Rim	Permitted Rims	Type	Tube
<b>420/85R38</b> 149A8 (16.9R38)	<b>TM600</b>	440	1665	766	5000	800	W14L	DW14L - W15L DW15L	TUBELESS	

With ProgressiveTraction® profile

**PRESSURE**

**H**

psi	<b>9</b>	<b>12</b>	<b>14</b>	<b>17</b>	<b>20</b>	<b>23</b>	<b>29</b>	<b>35</b>	<b>41</b>	<b>42</b>	<b>43</b>
bar	<b>0,6</b>	<b>0,8</b>	<b>1,0</b>	<b>1,2</b>	<b>1,4</b>	<b>1,6</b>	<b>2,0</b>	<b>2,4</b>	<b>2,8</b>	<b>2,9</b>	<b>3,0</b>

**MAX. LOAD kg**

50 S		1530	1755	2015	2275	2535	2795	3055	3250		
<b>40 S</b>		1530	1755	2015	2275	2535	2795	3055	<b>3250</b>		
30 S		1640	1880	2160	2435	2715	2995	3270	3480		
10 LT S		2070	2370	2725	3075	3425	3775	4125	4390	4785	4940
10 HT S		1640	1880	2160	2435	2715	2995	3270	3480		

SIZE	Tread pattern	SW mm	OD mm	SLR mm	RC mm	SRI	Rim	Permitted Rims	Type	Tube
<b>460/85R38</b> 149A8 (146B) (18.4R38)	<b>TM600</b>	475	1747	800	5260	825	W16L	W15L - DW15L DW16L	TUBELESS	18.4-38 TR218

**PRESSURE**

**H**

psi	<b>6</b>	<b>9</b>	<b>12</b>	<b>14</b>	<b>17</b>	<b>20</b>	<b>23</b>	<b>26</b>	<b>28</b>	<b>30</b>
bar	<b>0,4</b>	<b>0,6</b>	<b>0,8</b>	<b>1,0</b>	<b>1,2</b>	<b>1,4</b>	<b>1,6</b>	<b>1,8</b>	<b>1,9</b>	<b>2,1</b>

**MAX. LOAD kg**

50 S			1950	2155	2360	2560	2760	3000			
<b>40 S</b>			2140	2365	2590	2810	3030	<b>3250</b>			
30 S			2290	2535	2775	3010	3245	3480			
10 LT S		2595	2900	3205	3510	3815	4120	4425	4725	4875	5525
10 HT S			2290	2535	2775	3010	3245	3480			

\* Available also in Heavy Duty version

**TM600 - TM600 Rice**

Radial tire for tractors, sprayers and spreaders



SIZE	Tread pattern	SW mm	OD mm	SLR mm	RC mm	SRI	Rim	Permitted Rims	Type	Tube		
<b>480/80R38</b> 149A8 (149B)	<b>TM600</b>	495	1760	786	5235	825	W16A	W15 - DW15 DW16	TUBELESS			
With ProgressiveTraction® profile												
<b>PRESSURE</b>										<b>H</b>		
<b>psi</b>		<b>6</b>	<b>9</b>	<b>12</b>	<b>14</b>	<b>17</b>	<b>20</b>	<b>23</b>	<b>26</b>	<b>28</b>	<b>30</b>	
<b>bar</b>		<b>0,4</b>	<b>0,6</b>	<b>0,8</b>	<b>1</b>	<b>1,2</b>	<b>1,4</b>	<b>1,6</b>	<b>1,8</b>	<b>1,9</b>	<b>2,1</b>	
<b>MAX. LOAD kg</b>												
50 S				2140	2365	2590	2810	3030	3250			
<b>40 S</b>				2140	2365	2590	2810	3030	<b>3250</b>			
30 S				2290	2535	2775	3010	3245	3480			
10 LT S			2595	2900	3205	3510	3815	4120	4425	4725	4875	5525
10 HT S				2290	2535	2775	3010	3245	3480			

SIZE	Tread pattern	SW mm	OD mm	SLR mm	RC mm	SRI	Rim	Permitted Rims	Type	Tube		
<b>520/85R38</b> 155A8 (152B) (20.8R38)	<b>TM600</b>	536	1849	825	5510	875	DW18L	W16L - W18L DW16L	TUBELESS	20.8-38 TR218		
<b>PRESSURE</b>										<b>H</b>		
<b>psi</b>		<b>6</b>	<b>9</b>	<b>12</b>	<b>14</b>	<b>17</b>	<b>20</b>	<b>23</b>	<b>26</b>	<b>28</b>	<b>30</b>	
<b>bar</b>		<b>0,4</b>	<b>0,6</b>	<b>0,8</b>	<b>1,0</b>	<b>1,2</b>	<b>1,4</b>	<b>1,6</b>	<b>1,8</b>	<b>1,9</b>	<b>2,1</b>	
<b>MAX. LOAD kg</b>												
50 S				2325	2565	2805	3045	3290	3550			
<b>40 S</b>				2550	2815	3080	3345	3610	<b>3875</b>			
30 S				2730	3015	3300	3580	3865	4150			
10 LT S			3105	3470	3835	4195	4555	4915	5275	5635	5815	6590
10 HT S				2730	3015	3300	3580	3865	4150			

\* Available also in Heavy Duty version

SIZE	Tread pattern	SW mm	OD mm	SLR mm	RC mm	SRI	Rim	Permitted Rims	Type	Tube		
<b>520/85R38</b> 155A8 (152B)	<b>TM600</b>	562	1849	820	5550	875	DW18L	W16L - W18L - DW16L	TUBELESS	20.8-38 TR218		
With ProgressiveTraction® profile												
<b>PRESSURE</b>										<b>H</b>		
<b>psi</b>		<b>6</b>	<b>9</b>	<b>12</b>	<b>14</b>	<b>17</b>	<b>20</b>	<b>23</b>	<b>26</b>	<b>28</b>	<b>30</b>	
<b>bar</b>		<b>0,4</b>	<b>0,6</b>	<b>0,8</b>	<b>1,0</b>	<b>1,2</b>	<b>1,4</b>	<b>1,6</b>	<b>1,8</b>	<b>1,9</b>	<b>2,1</b>	
<b>MAX. LOAD kg</b>												
50 S				2325	2565	2805	3045	3290	3550			
<b>40 S</b>				2550	2815	3080	3345	3610	<b>3875</b>			
30 S				2730	3015	3300	3580	3865	4150			
10 LT S			3105	3470	3835	4195	4555	4915	5275	5635	5815	6590
10 HT S				2730	3015	3300	3580	3865	4150			

SIZE	Tread pattern	SW mm	OD mm	SLR mm	RC mm	SRI	Rim	Permitted Rims	Type	Tube
<b>480/80R42</b> 151A8 (151B) (18.4R42)	<b>TM600</b>	495	1850	833	5550	875	W16A	DD16 - DW16B DW16L	TUBELESS	18.4-42 20.8-42 TR218

**PRESSURE**

**H**

psi	<b>6</b>	<b>9</b>	<b>12</b>	<b>14</b>	<b>17</b>	<b>20</b>	<b>23</b>	<b>26</b>	<b>28</b>	<b>30</b>
bar	<b>0,4</b>	<b>0,6</b>	<b>0,8</b>	<b>1,0</b>	<b>1,2</b>	<b>1,4</b>	<b>1,6</b>	<b>1,8</b>	<b>1,9</b>	<b>2,1</b>

**MAX. LOAD kg**

50 S				2270	2505	2745	2985	3220	3450			
<b>40 S</b>				2270	2505	2745	2985	3220	<b>3450</b>			
30 S				2430	2685	2940	3195	3445	3695			
10 LT S			2770	3085	3410	3735	4060	4375	4695	5015	5175	5865
10 HT S				2430	2685	2940	3195	3445	3695			

\* Available also in Heavy Duty version

SIZE	Tread pattern	SW mm	OD mm	SLR mm	RC mm	SRI	Rim	Permitted Rims	Type	Tube
<b>520/85R42</b> 157A8 (157B) (20.8R42)	<b>TM600</b>	536	1952	881	5867	925	DW18L	W16L - W18L DW16L	TUBELESS	20.8-42 TR218

**PRESSURE**

**H**

psi	<b>6</b>	<b>9</b>	<b>12</b>	<b>14</b>	<b>17</b>	<b>20</b>	<b>23</b>	<b>26</b>	<b>28</b>	<b>30</b>
bar	<b>0,4</b>	<b>0,6</b>	<b>0,8</b>	<b>1,0</b>	<b>1,2</b>	<b>1,4</b>	<b>1,6</b>	<b>1,8</b>	<b>1,9</b>	<b>2,1</b>

**MAX. LOAD kg**

50 S				2710	2995	3280	3565	3845	4125			
<b>40 S</b>				2710	2995	3280	3565	3845	<b>4125</b>			
30 S				2900	3205	3510	3815	4115	4415			
10 LT S			3305	3690	4075	4460	4845	5230	5615	6000	6190	7015
10 HT S				2900	3205	3510	3815	4115	4415			

\* Available also in Heavy Duty version

SIZE	Tread pattern	SW mm	OD mm	SLR mm	RC mm	SRI	Rim	Permitted Rims	Type	Tube
<b>520/85R42</b> 162A8 (162B) (20.8R42)	<b>TM600</b>	560	1952	881	5867	925	DW18L	W16L - W18L DW16L	TUBELESS	20.8-42 TR218

**PRESSURE**

**H**

psi	<b>9</b>	<b>12</b>	<b>15</b>	<b>17</b>	<b>20</b>	<b>23</b>	<b>29</b>	<b>35</b>	<b>41</b>	<b>42</b>	<b>43</b>
bar	<b>0,6</b>	<b>0,8</b>	<b>1,0</b>	<b>1,2</b>	<b>1,4</b>	<b>1,6</b>	<b>2,0</b>	<b>2,4</b>	<b>2,8</b>	<b>2,9</b>	<b>3,0</b>

**MAX. LOAD kg**

50 S				2235	2565	2945	3325	3705	4085	4465	4750	
<b>40 S</b>				2235	2565	2945	3325	3705	4085	4465	<b>4750</b>	
30 S				2390	2745	3155	3560	3965	4375	4780	5085	
10 LT S				3010	3460	3970	4480	4995	5505	6015	6400	6995 7140 8090
10 HT S				2390	2745	3155	3560	3965	4375	4780	5085	

**TM600 - TM600 Rice**

Radial tire for tractors, sprayers and spreaders



SIZE	Tread pattern	SW mm	OD mm	SLR mm	RC mm	SRI	Rim	Permitted Rims	Type	Tube
<b>480/80R46</b> 158A8 (158B) (18.4R46)	<b>TM600</b>	495	1964	887	5950	925	W16A	DD16 - DW16B	TUBELESS	

**PRESSURE**

**H**

<b>psi</b>	<b>9</b>	<b>12</b>	<b>14</b>	<b>17</b>	<b>20</b>	<b>23</b>	<b>29</b>	<b>35</b>	<b>41</b>	<b>42</b>	<b>43</b>
<b>bar</b>	<b>0,6</b>	<b>0,8</b>	<b>1,0</b>	<b>1,2</b>	<b>1,4</b>	<b>1,6</b>	<b>2,0</b>	<b>2,4</b>	<b>2,8</b>	<b>2,9</b>	<b>3,0</b>

**MAX. LOAD kg**

50 S		2000	2295	2635	2975	3315	3655	3995	4250			
<b>40 S</b>		2000	2295	2635	2975	3315	3655	3995	<b>4250</b>			
30 S		2140	2460	2820	3185	3550	3915	4275	4550			
10 LT S		2720	3125	3585	4050	4510	4975	5435	5740	6260	6390	7240
10 HT S		2140	2460	2820	3185	3550	3915	4275	4550			

SIZE	Tread pattern	SW mm	OD mm	SLR mm	RC mm	SRI	Rim	Permitted Rims	Type	Tube
<b>520/85R46</b> 158A8 (158B) (20.8R46)	<b>TM600</b>	535	2045	905	6160	975	DW16L	W16L - W18L - DW16L DD16L - DD18L	TUBELESS	

**PRESSURE**

**H**

<b>psi</b>	<b>9</b>	<b>12</b>	<b>14</b>	<b>17</b>	<b>20</b>	<b>23</b>	<b>26</b>	<b>28</b>	<b>30</b>
<b>bar</b>	<b>0,6</b>	<b>0,8</b>	<b>1,0</b>	<b>1,2</b>	<b>1,4</b>	<b>1,6</b>	<b>1,8</b>	<b>1,9</b>	<b>2,1</b>

**MAX. LOAD kg**

50 S		2765	3055	3345	3630	3910	4250				
<b>40 S</b>		2765	3055	3345	3630	3910	<b>4250</b>				
30 S		2960	3270	3580	3885	4185	4550				
10 LT S		3760	4155	4550	4935	5320	5780	6180	6375	7225	
10 HT S		2960	3270	3580	3885	4185	4550				

SIZE	Tread pattern	SW mm	OD mm	SLR mm	RC mm	SRI	Rim	Permitted Rims	Type	Tube
<b>480/80R50</b> 159D	<b>TM600</b>	500	2045	935	6190	975	DW15B	DW16B	TUBELESS	

**PRESSURE**

**H**

<b>psi</b>	<b>9</b>	<b>12</b>	<b>14</b>	<b>17</b>	<b>20</b>	<b>23</b>	<b>29</b>	<b>35</b>	<b>41</b>	<b>42</b>	<b>43</b>
<b>bar</b>	<b>0,6</b>	<b>0,8</b>	<b>1,0</b>	<b>1,2</b>	<b>1,4</b>	<b>1,6</b>	<b>2,0</b>	<b>2,4</b>	<b>2,8</b>	<b>2,9</b>	<b>3,0</b>

**MAX. LOAD kg**

<b>65 S</b>				2715	3065	3415	3765	4115	<b>4375</b>			
50 S		2160	2485	2850	3220	3585	3955	4320	4595			
40 S		2255	2590	2975	3355	3740	4120	4505	4795			
30 S		2365	2720	3120	3525	3925	4330	4730	5035			
10 LT S		2800	3215	3690	4165	4645	5120	5595	5950	6370	6565	7440
10 HT S		2365	2720	3120	3525	3925	4330	4730	5035			



SIZE	Tread pattern	SW mm	OD mm	SLR mm	RC mm	SRI	Rim	Permitted Rims	Type	Tube			
<b>480/95R50</b> 164A8 (164B)	<b>TM600</b>	500	2148	982	6490	1050	DW16B	DW16A - DW15A DW15B	TUBELESS				
With ProgressiveTraction® profile													
<b>PRESSURE</b>										<b>H</b>			
psi			<b>9</b>	<b>12</b>	<b>14</b>	<b>17</b>	<b>20</b>	<b>23</b>	<b>29</b>	<b>35</b>	<b>41</b>	<b>42</b>	<b>43</b>
bar			<b>0,6</b>	<b>0,8</b>	<b>1,0</b>	<b>1,2</b>	<b>1,4</b>	<b>1,6</b>	<b>2,0</b>	<b>2,4</b>	<b>2,8</b>	<b>2,9</b>	<b>3,0</b>
<b>MAX. LOAD kg</b>													
50 S			2350	2700	3100	3500	3900	4300	4700	5000			
<b>40 S</b>			2350	2700	3100	3500	3900	4300	4700	<b>5000</b>			
30 S			2515	2890	3320	3745	4175	4605	5030	5350			
10 LT S			3175	3645	4185	4725	5265	5805	6345	6750	7360	7595	8505
10 HT S			2515	2890	3320	3745	4175	4605	5030	5350			

SIZE	Tread pattern	SW mm	OD mm	SLR mm	RC mm	SRI	Rim	Permitted Rims	Type	Tube			
<b>480/80R50</b> 159A8 (159B)	<b>TM600 Rice</b>	490	2045	942	6185	975	DW15B		TUBELESS				
With ProgressiveTraction® profile													
<b>PRESSURE</b>										<b>H</b>			
psi			<b>9</b>	<b>12</b>	<b>15</b>	<b>17</b>	<b>20</b>	<b>23</b>	<b>29</b>	<b>35</b>	<b>41</b>	<b>42</b>	<b>44</b>
bar			<b>0,6</b>	<b>0,8</b>	<b>1,0</b>	<b>1,2</b>	<b>1,4</b>	<b>1,6</b>	<b>2,0</b>	<b>2,4</b>	<b>2,8</b>	<b>2,9</b>	<b>3,0</b>
<b>MAX. LOAD kg</b>													
50 S			2060	2365	2715	3065	3415	3765	4070	4375			
40 S			2060	2365	2715	3065	3415	3765	4070	<b>4375</b>			
30 S			2205	2530	2905	3280	3655	4030	4355	4685			
10 LT S			2770	3185	3655	4130	4600	5070	5485	5895	6445	6575	7450
10 HT S			2205	2530	2905	3280	3655	4030	4355	4685			

For technical notes about pressure tables please refer to page 260.

## TM600 - TM600 Rice

Radial tire for tractors, sprayers and spreaders



# TM150



The TM150, designed according to **BLUE/TIRE** technology, is Trelleborg's answer to the new generation of fertilizers and self-propelled high powered sprayers. In line with the VF standards, the TM150 tires can carry high loads while assuring low soil compaction, minimizing ruts and boosting crop yields.



SIZE	
VF 380/90R46	173D
VF 380/105R46	178D
VF 480/80R46	177D
VF 520/85R46	173D

SIZE	
VF 380/105R50	179D
VF 480/80R50	179D
VF 520/85R50	177D
VF 380/105R54*	178D

\* = in preparation

SIZE	Tread pattern	SW mm	OD mm	SLR mm	RC mm	SRI	Rim	Permitted Rims	Type	Tube
VF 380/90R46 173D	TM150	390	1840	840	5550	900	DW13	W13 - DW12 - W12	TUBELESS	

### PRESSURE

psi	15	17	23	29	32	35	41	46	52	58	64
bar	1,0	1,2	1,6	2,0	2,2	2,4	2,8	3,2	3,6	4,0	4,4

### MAX. LOAD kg

40 to 65 km/h (S)	2840	3195	3905	4285	4375	4625	5000	5450	5800	6000	6500
30 (S)	2895	3260	3985	4370	4465	4720	5100	5560	5915	6120	6630
20 (S)	2955	3325	4060	4455	4550	4810	5200	5670	6030	6240	6760
10 LT (S)	3125	3515	4295	4715	4815	5090	5500	5995	6380	6600	7150

SIZE	Tread pattern	SW mm	OD mm	SLR mm	RC mm	SRI	Rim	Permitted Rims	Type	Tube		
<b>VF 380/105R46</b> 178D	<b>TM150</b>	400	1955	890	5950	950	DW13	W13 - DW12 - W12	TUBELESS			
<b>PRESSURE</b>												
<b>psi</b>		<b>15</b>	<b>17</b>	<b>23</b>	<b>29</b>	<b>32</b>	<b>35</b>	<b>41</b>	<b>46</b>	<b>52</b>	<b>58</b>	<b>64</b>
<b>bar</b>		<b>1,0</b>	<b>1,2</b>	<b>1,6</b>	<b>2,0</b>	<b>2,2</b>	<b>2,4</b>	<b>2,8</b>	<b>3,2</b>	<b>3,6</b>	<b>4,0</b>	<b>4,4</b>
<b>MAX. LOAD kg</b>												
<b>40 to 65 km/h (S)</b>		3225	3600	4425	4875	5025	5175	5700	6150	6525	6900	<b>7500</b>
30 (S)		3290	3670	4515	4975	5125	5280	5815	6275	6655	7040	7650
20 (S)		3355	3745	4600	5070	5225	5380	5930	6395	6785	7175	7800
10 LT (S)		3550	3960	4870	5365	5530	5695	6270	6765	7180	7590	8250

SIZE	Tread pattern	SW mm	OD mm	SLR mm	RC mm	SRI	Rim	Permitted Rims	Type	Tube	
<b>VF480/80R46</b> 177D	<b>TM150</b>	480	1950	880	5915	925	DW16	DW15	TUBELESS		
<b>PRESSURE</b>											
<b>psi</b>		<b>15</b>	<b>17</b>	<b>20</b>	<b>23</b>	<b>32</b>	<b>38</b>	<b>42</b>	<b>46</b>	<b>49</b>	<b>52</b>
<b>bar</b>		<b>1,0</b>	<b>1,2</b>	<b>1,4</b>	<b>1,6</b>	<b>2,2</b>	<b>2,6</b>	<b>2,9</b>	<b>3,2</b>	<b>3,4</b>	<b>3,6</b>
<b>MAX. LOAD kg</b>											
<b>40 to 65 km/h (S)</b>		3605	4055	4505	4955	5635	6075	6480	6850	7080	<b>7300</b>
30 (S)		3675	4135	4595	5055	5750	6195	6610	6985	7220	7445
20 (S)		3750	4215	4685	5155	5860	6320	6740	7125	7365	7590
10 LT (S)		3965	4460	4955	5450	6200	6685	7130	7535	7790	8030

SIZE	Tread pattern	SW mm	OD mm	SLR mm	RC mm	SRI	Rim	Permitted Rims	Type	Tube
<b>VF 520/85R46</b> 173D	<b>TM150</b>	540	2055	905	6155	975	DW18L		TUBELESS	
<b>PRESSURE</b>										
<b>psi</b>		<b>12</b>	<b>14</b>	<b>17</b>	<b>20</b>	<b>23</b>	<b>26</b>	<b>29</b>		
<b>bar</b>		<b>0,8</b>	<b>1,0</b>	<b>1,2</b>	<b>1,4</b>	<b>1,6</b>	<b>1,8</b>	<b>2,0</b>		
<b>MAX. LOAD kg</b>										
<b>40 to 65 km/h (S)</b>		3775	4335	4895	5455	6015	6225	<b>6500</b>		
30 (S)		3850	4420	4995	5565	6135	6350	6630		
20 (S)		3925	4510	5090	5675	6255	6475	6760		
10 LT (S)		4155	4770	5385	6000	6615	6850	7150		

## TM150

Radial tire for tractors, sprayers and spreaders



SIZE	Tread pattern	SW mm	OD mm	SLR mm	RC mm	SRI	Rim	Permitted Rims	Type	Tube		
VF 380/105R50 179D	TM150	410	2050	935	6215	1000	DW13	W13 - DW12 - W12	TUBELESS			
<b>PRESSURE</b>												
psi		<b>15</b>	<b>17</b>	<b>23</b>	<b>29</b>	<b>32</b>	<b>35</b>	<b>41</b>	<b>46</b>	<b>52</b>	<b>58</b>	<b>64</b>
bar		<b>1,0</b>	<b>1,2</b>	<b>1,6</b>	<b>2,0</b>	<b>2,2</b>	<b>2,4</b>	<b>2,8</b>	<b>3,2</b>	<b>3,6</b>	<b>4,0</b>	<b>4,4</b>
<b>MAX. LOAD kg</b>												
<b>40 to 65 km/h (S)</b>		3335	3720	4575	5040	5195	5350	5890	6355	6745	7130	<b>7750</b>
30 (S)		3400	3795	4665	5140	5300	5455	6010	6480	6880	7275	7905
20 (S)		3470	3870	4760	5240	5405	5565	6125	6610	7015	7415	8060
10 LT (S)		3670	4090	5035	5545	5715	5885	6480	6990	7420	7845	8525

SIZE	Tread pattern	SW mm	OD mm	SLR mm	RC mm	SRI	Rim	Permitted Rims	Type	Tube	
VF 480/80R50 179D	TM150	490	2050	930	6205	975	DW16	DW15	TUBELESS		
<b>PRESSURE</b>											
psi		<b>15</b>	<b>17</b>	<b>20</b>	<b>23</b>	<b>32</b>	<b>38</b>	<b>42</b>	<b>46</b>	<b>49</b>	<b>52</b>
bar		<b>1,0</b>	<b>1,2</b>	<b>1,4</b>	<b>1,6</b>	<b>2,2</b>	<b>2,6</b>	<b>2,9</b>	<b>3,2</b>	<b>3,4</b>	<b>3,6</b>
<b>MAX. LOAD kg</b>											
<b>40 to 65 km/h (S)</b>		3825	4305	4785	5260	5980	6450	6875	7270	7520	<b>7750</b>
30 (S)		3900	4390	4880	5365	6100	6580	7015	7415	7670	7905
20 (S)		3980	4475	4975	5470	6220	6710	7150	7560	7820	8060
10 LT (S)		4210	4735	5265	5785	6580	7095	7565	7995	8270	8525

SIZE	Tread pattern	SW mm	OD mm	SLR mm	RC mm	SRI	Rim	Permitted Rims	Type	Tube
VF 520/85R50 177D	TM150	545	2165	955	6490	1025	DW16L		TUBELESS	
<b>PRESSURE</b>										
psi		<b>12</b>	<b>14</b>	<b>17</b>	<b>20</b>	<b>23</b>	<b>26</b>	<b>29</b>	<b>32</b>	<b>35</b>
bar		<b>0,8</b>	<b>1,0</b>	<b>1,2</b>	<b>1,4</b>	<b>1,6</b>	<b>1,8</b>	<b>2,0</b>	<b>2,2</b>	<b>2,4</b>
<b>MAX. LOAD kg</b>										
<b>40 to 65 km/h (S)</b>		3950	4515	5080	5645	6210	6530	6815	7055	<b>7300</b>
30 (S)		4030	4605	5180	5755	6330	6660	6950	7195	7400
20 (S)		4110	4695	5285	5870	6455	6790	7085	7335	7545
10 LT (S)		4345	4965	5585	6210	6830	7185	7495	7760	7980

For technical notes about pressure tables please refer to page 260.

## TM150



# TM100



Narrow radial tire, particularly suitable for row crop working and highly regarded for the comfort it delivers.

## SIZE

**230/95R32 128A8 (128B)**

**270/95R32 136A8 (136B)**

**230/95R36 130A8 (130B)**

**270/95R38 140A8 (140B)**

**210/95R44 120A8 (120B)**

**230/95R44 134A8 (134B)**

**270/95R44 142A8 (142B)**

## SIZE

**300/95R46 148A8 (148B)**

**230/95R48 136A8 (136B)**

**270/95R48 144A8 (144B)**

**380/90R50 151A8 (151B)**

**300/95R52 151A8 (151B)**

**380/90R54 152A8 (152B)**

SIZE	Tread pattern	SW mm	OD mm	SLR mm	RC mm	SRI	Rim	Permitted Rims	Type	Tube
<b>230/95R32</b> 128A8 (128B)	<b>TM100</b>	235	1265	595	3900	600	W7	W6	TUBELESS	9.5-32 TR218

### PRESSURE

psi	<b>14</b>	<b>17</b>	<b>20</b>	<b>23</b>	<b>29</b>	<b>35</b>	<b>41</b>	<b>46</b>	<b>52</b>	<b>58</b>	<b>64</b>
bar	<b>1,0</b>	<b>1,2</b>	<b>1,4</b>	<b>1,6</b>	<b>2,0</b>	<b>2,4</b>	<b>2,8</b>	<b>3,2</b>	<b>3,6</b>	<b>4,0</b>	<b>4,4</b>

### MAX. LOAD kg

50 S							1300	1425	1550	1675	1800
<b>40 S</b>		810	920	1010	1120	1210	1300	1425	1550	1675	<b>1800</b>
30 S		870	985	1080	1195	1295	1390	1525	1660	1795	1930
10 Cyc S		1095	1240	1365	1510	1630	1750	1920	2090	2260	2700

SIZE	Tread pattern	SW mm	OD mm	SLR mm	RC mm	SRI	Rim	Permitted Rims	Type	Tube
<b>270/95R32</b> 136A8 (136B)	<b>TM100</b>	280	1345	635	4075	650	W9	W10 - W8	TUBELESS	12.4-32 TR218

### PRESSURE

psi	<b>14</b>	<b>17</b>	<b>20</b>	<b>23</b>	<b>29</b>	<b>35</b>	<b>41</b>	<b>46</b>	<b>52</b>	<b>58</b>	<b>64</b>
bar	<b>1,0</b>	<b>1,2</b>	<b>1,4</b>	<b>1,6</b>	<b>2,0</b>	<b>2,4</b>	<b>2,8</b>	<b>3,2</b>	<b>3,6</b>	<b>4,0</b>	<b>4,4</b>

### MAX. LOAD kg

50 S							1615	1770	1930	2085	2240
<b>40 S</b>		1010	1145	1255	1390	1505	1615	1770	1930	2085	<b>2240</b>
30 S		1080	1225	1345	1490	1610	1730	1895	2065	2230	2400
10 Cyc S		1365	1545	1695	1875	2030	2180	2390	2605	2815	3360

## TM100

Radial tire for tractors, sprayers and spreaders



SIZE	Tread pattern	SW mm	OD mm	SLR mm	RC mm	SRI	Rim	Permitted Rims	Type	Tube			
<b>230/95R36</b> 130A8 (130B)	<b>TM100</b>	235	1365	645	4210	650	W7	W6	TUBELESS	9,5-36 TR218			
<b>PRESSURE</b>													
<b>psi</b>			<b>14</b>	<b>17</b>	<b>20</b>	<b>23</b>	<b>29</b>	<b>35</b>	<b>41</b>	<b>46</b>	<b>52</b>	<b>58</b>	<b>64</b>
<b>bar</b>			<b>1,0</b>	<b>1,2</b>	<b>1,4</b>	<b>1,6</b>	<b>2,0</b>	<b>2,4</b>	<b>2,8</b>	<b>3,2</b>	<b>3,6</b>	<b>4,0</b>	<b>4,4</b>
<b>MAX. LOAD kg</b>													
50 S								1370	1505	1635	1770	1900	
<b>40 S</b>			855	970	1065	1180	1275	1370	1505	1635	1770	<b>1900</b>	
30 S			915	1040	1140	1265	1365	1465	1610	1750	1895	2035	
10 Cyc S			1155	1310	1440	1595	1720	1850	2030	2210	2390	2565	2850

SIZE	Tread pattern	SW mm	OD mm	SLR mm	RC mm	SRI	Rim	Permitted Rims	Type	Tube			
<b>270/95R38</b> 140A8 (140B)	<b>TM100</b>	285	1480	697	4505	725	W10	W8 - W9	TUBELESS				
<b>PRESSURE</b>													
<b>psi</b>			<b>14</b>	<b>17</b>	<b>20</b>	<b>23</b>	<b>29</b>	<b>35</b>	<b>41</b>	<b>46</b>	<b>52</b>	<b>58</b>	<b>64</b>
<b>bar</b>			<b>1,0</b>	<b>1,2</b>	<b>1,4</b>	<b>1,6</b>	<b>2,0</b>	<b>2,4</b>	<b>2,8</b>	<b>3,2</b>	<b>3,6</b>	<b>4,0</b>	<b>4,4</b>
<b>MAX. LOAD kg</b>													
50 S								1875	2050	2225	2375	2500	
<b>40 S</b>			1175	1325	1475	1600	1750	1875	2050	2225	2375	<b>2500</b>	
30 S			1260	1420	1580	1715	1875	2010	2195	2385	2545	2675	
10 Cyc S			1590	1790	1995	2160	2365	2535	2770	3005	3210	3375	3750

SIZE	Tread pattern	SW mm	OD mm	SLR mm	RC mm	SRI	Rim	Permitted Rims	Type	Tube			
<b>210/95R44</b> 120A8 (120B)	<b>TM100</b>	210	1530	725	4670	750	W7	W6	TUBELESS	8,3/9,5-44 TR218			
<b>PRESSURE</b>													
<b>psi</b>			<b>14</b>	<b>17</b>	<b>20</b>	<b>23</b>	<b>29</b>	<b>35</b>	<b>41</b>	<b>46</b>	<b>52</b>	<b>58</b>	<b>64</b>
<b>bar</b>			<b>1,0</b>	<b>1,2</b>	<b>1,4</b>	<b>1,6</b>	<b>2,0</b>	<b>2,4</b>	<b>2,8</b>	<b>3,2</b>	<b>3,6</b>	<b>4,0</b>	<b>4,4</b>
<b>MAX. LOAD kg</b>													
50 S								1400					
<b>40 S</b>			870	980	1095	1205	1320	<b>1400</b>					
30 S			930	1050	1170	1290	1410	1500					
10 Cyc S			1175	1325	1475	1630	1780	1890	2100				

According to availability

SIZE	Tread pattern	SW mm	OD mm	SLR mm	RC mm	SRI	Rim	Permitted Rims	Type	Tube			
<b>230/95R44</b> 134A8 (134B)	<b>TM100</b>	235	1570	735	4850	750	W7	W8	TUBELESS	8.3/9.5-44 TR218			
<b>PRESSURE</b>													
psi			<b>14</b>	<b>17</b>	<b>20</b>	<b>23</b>	<b>29</b>	<b>35</b>	<b>41</b>	<b>46</b>	<b>52</b>	<b>58</b>	<b>64</b>
bar			<b>1,0</b>	<b>1,2</b>	<b>1,4</b>	<b>1,6</b>	<b>2,0</b>	<b>2,4</b>	<b>2,8</b>	<b>3,2</b>	<b>3,6</b>	<b>4,0</b>	<b>4,4</b>
<b>MAX. LOAD kg</b>													
50 S								1530	1675	1825	1975	2120	
<b>40 S</b>			955	1085	1190	1315	1425	1530	1675	1825	1975	<b>2120</b>	
30 S			1025	1160	1275	1410	1520	1635	1795	1955	2110	2270	
10 Cyc S			1290	1460	1605	1775	1920	2065	2265	2465	2665	2865	3180

SIZE	Tread pattern	SW mm	OD mm	SLR mm	RC mm	SRI	Rim	Permitted Rims	Type	Tube			
<b>270/95R44</b> 142A8 (142B)	<b>TM100</b>	270	1645	770	5020	800	W8	W9 - W10	TUBELESS	9.5-44 TR218			
<b>PRESSURE</b>													
psi			<b>14</b>	<b>17</b>	<b>20</b>	<b>23</b>	<b>29</b>	<b>35</b>	<b>41</b>	<b>46</b>	<b>52</b>	<b>58</b>	<b>64</b>
bar			<b>1,0</b>	<b>1,2</b>	<b>1,4</b>	<b>1,6</b>	<b>2,0</b>	<b>2,4</b>	<b>2,8</b>	<b>3,2</b>	<b>3,6</b>	<b>4,0</b>	<b>4,4</b>
<b>MAX. LOAD kg</b>													
50 S								1910	2095	2280	2465	2650	
<b>40 S</b>			1195	1355	1485	1645	1780	1910	2095	2280	2465	<b>2650</b>	
30 S			1280	1450	1590	1760	1900	2045	2245	2440	2640	2840	
10 Cyc S			1610	1825	2005	2220	2400	2580	2830	3080	3330	3580	3975

SIZE	Tread pattern	SW mm	OD mm	SLR mm	RC mm	SRI	Rim	Permitted Rims	Type	Tube			
<b>300/95R46</b> 148A8 (148B)	<b>TM100</b>	310	1755	840	5400	850	W10	W9 - W11	TUBELESS	12.4-46			
<b>PRESSURE</b>													
psi			<b>14</b>	<b>17</b>	<b>20</b>	<b>23</b>	<b>29</b>	<b>35</b>	<b>41</b>	<b>46</b>	<b>52</b>	<b>58</b>	<b>64</b>
bar			<b>1,0</b>	<b>1,2</b>	<b>1,4</b>	<b>1,6</b>	<b>2,0</b>	<b>2,4</b>	<b>2,8</b>	<b>3,2</b>	<b>3,6</b>	<b>4,0</b>	<b>4,4</b>
<b>MAX. LOAD kg</b>													
50 S								2270	2490	2710	2930	3150	
<b>40 S</b>			1420	1610	1765	1955	2115	2270	2490	2710	2930	<b>3150</b>	
30 S			1520	1720	1890	2090	2260	2430	2665	2900	3135	3375	
10 Cyc S			1915	2170	2385	2640	2850	3065	3360	3660	3955	4255	4725

## TM100

Radial tire for tractors, sprayers and spreaders



SIZE	Tread pattern	SW mm	OD mm	SLR mm	RC mm	SRI	Rim	Permitted Rims	Type	Tube			
<b>230/95R48</b> 136A8 (136B)	<b>TM100</b>	238	1673	780	5170	800	W7	W8	TUBELESS	9,5-48			
<b>PRESSURE</b>													
<b>psi</b>			<b>14</b>	<b>17</b>	<b>20</b>	<b>23</b>	<b>29</b>	<b>35</b>	<b>41</b>	<b>46</b>	<b>52</b>	<b>58</b>	<b>64</b>
<b>bar</b>			<b>1,0</b>	<b>1,2</b>	<b>1,4</b>	<b>1,6</b>	<b>2,0</b>	<b>2,4</b>	<b>2,8</b>	<b>3,2</b>	<b>3,6</b>	<b>4,0</b>	<b>4,4</b>
<b>MAX. LOAD kg</b>													
50 S								1615	1770	1930	2085	2240	
<b>40 S</b>			1010	1145	1255	1390	1505	1615	1770	1930	2085	<b>2240</b>	
30 S			1080	1225	1345	1490	1610	1730	1895	2065	2230	2400	
10 Cyc S			1365	1545	1695	1875	2030	2180	2390	2605	2815	3025	3360

SIZE	Tread pattern	SW mm	OD mm	SLR mm	RC mm	SRI	Rim	Permitted Rims	Type	Tube			
<b>270/95R48</b> 144A8 (144B)	<b>TM100</b>	275	1750	830	5350	850	W8	W9 - W10	TUBELESS	11.2-48			
<b>PRESSURE</b>													
<b>psi</b>			<b>14</b>	<b>17</b>	<b>20</b>	<b>23</b>	<b>29</b>	<b>35</b>	<b>41</b>	<b>46</b>	<b>52</b>	<b>58</b>	<b>64</b>
<b>bar</b>			<b>1,0</b>	<b>1,2</b>	<b>1,4</b>	<b>1,6</b>	<b>2,0</b>	<b>2,4</b>	<b>2,8</b>	<b>3,2</b>	<b>3,6</b>	<b>4,0</b>	<b>4,4</b>
<b>MAX. LOAD kg</b>													
50 S								2020	2215	2410	2605	2800	
<b>40 S</b>			1260	1430	1570	1740	1880	2020	2215	2410	2605	<b>2800</b>	
30 S			1350	1530	1680	1860	2010	2160	2370	2580	2790	3000	
10 Cyc S			1705	1930	2120	2345	2535	2725	2990	3255	3520	3780	4200

SIZE	Tread pattern	SW mm	OD mm	SLR mm	RC mm	SRI	Rim	Permitted Rims	Type	Tube		
<b>380/90R50</b> 151A8 (151B)	<b>TM100</b>	390	1945	890	5885	950	W12	W11 - W13	TUBELESS			
<b>PRESSURE</b>												
<b>psi</b>			<b>14</b>	<b>17</b>	<b>20</b>	<b>23</b>	<b>29</b>	<b>35</b>	<b>41</b>	<b>42</b>	<b>43</b>	
<b>bar</b>			<b>1,0</b>	<b>1,2</b>	<b>1,4</b>	<b>1,6</b>	<b>2,0</b>	<b>2,4</b>	<b>2,8</b>	<b>2,9</b>	<b>3,0</b>	
<b>MAX. LOAD kg</b>												
50 S				2415	2695	2970	3245	3450				
<b>40 S</b>			2140	2415	2695	2970	3245	<b>3450</b>				
30 S			2290	2585	2880	3175	3475	3695				
10 LT S			2910	3285	3660	4040	4415	4695	5020	5175	5865	
10 HT S			2290	2585	2880	3175	3475	3695				



SIZE	Tread pattern	SW mm	OD mm	SLR mm	RC mm	SRI	Rim	Permitted Rims	Type	Tube			
<b>300/95R52</b> 151A8 (151B)	<b>TM100</b>	315	1905	890	5805	925	W10	W9 - W11 - DW10 DW11	TUBELESS				
<b>PRESSURE</b>													
<b>psi</b>			<b>14</b>	<b>17</b>	<b>20</b>	<b>23</b>	<b>29</b>	<b>35</b>	<b>41</b>	<b>46</b>	<b>52</b>	<b>58</b>	<b>64</b>
<b>bar</b>			<b>1,0</b>	<b>1,2</b>	<b>1,4</b>	<b>1,6</b>	<b>2,0</b>	<b>2,4</b>	<b>2,8</b>	<b>3,2</b>	<b>3,6</b>	<b>4,0</b>	<b>4,4</b>
<b>MAX. LOAD kg</b>													
50 S								2590	2830	3075	3280	3450	
<b>40 S</b>			1625	1830	2040	2210	2415	2590	2830	3075	3280	<b>3450</b>	
30 S			1740	1960	2180	2365	2585	2770	3030	3290	3510	3695	
10 Cyc S			2190	2470	2750	2985	3265	3495	3820	4150	4425	4660	5175

SIZE	Tread pattern	SW mm	OD mm	SLR mm	RC mm	SRI	Rim	Permitted Rims	Type	Tube		
<b>380/90R54</b> 152A8 (152B)	<b>TM100</b>	380	2040	940	6175	1025	W12	W11 - W13	TUBELESS			
<b>PRESSURE</b>												
<b>psi</b>			<b>14</b>	<b>17</b>	<b>20</b>	<b>23</b>	<b>29</b>	<b>35</b>	<b>41</b>	<b>42</b>	<b>43</b>	
<b>bar</b>			<b>1,0</b>	<b>1,2</b>	<b>1,4</b>	<b>1,6</b>	<b>2,0</b>	<b>2,4</b>	<b>2,8</b>	<b>2,9</b>	<b>3,0</b>	
<b>MAX. LOAD kg</b>												
50 S				2485	2770	3055	3340	3550				
<b>40 S</b>			2205	2485	2770	3055	3340	<b>3550</b>				
30 S			2360	2660	2965	3270	3575	3800				
10 LT S			2995	3380	3770	4155	4540	4830	5170	5325	6035	
10 HT S			2360	2660	2965	3270	3575	3800				

For technical notes about pressure tables please refer to page 260.

## TM100

Radial tire for tractors, sprayers and spreaders



# TM190

The special lug shape, which gradually widens toward the central tread zone, provides high resistance to gougings and lacerations and delivers even wear on both road and field. The TM190 is suitable for most operations and types of terrain, giving top performances in applications that involve a high level of road and field use, whether on normal cultivated terrain or hard, stony grounds.



The reduced height of its lugs makes it an especially good performer on grassland.

SIZE	
<b>7.50R20</b>	<b>6 PR</b>
<b>9.5R20</b>	<b>8 PR</b>
<b>8.3R24</b>	<b>8 PR</b>

SIZE	
<b>9.5R24</b>	<b>107A8</b>
<b>12.4R36</b>	<b>124A8 (121B)</b>

SIZE	Tread pattern	SW mm	OD mm	SLR mm	RC mm	SRI	Rim	Permitted Rims	Type	Tube
<b>7.50R20</b> 6 PR	<b>TM190</b>	200	910	422	2755	425	5.50F	6.00F	TUBE TYPE	7.5-20 TR15
<b>PRESSURE</b>										<b>H</b>
<b>psi</b>			<b>14</b>	<b>17</b>	<b>20</b>	<b>23</b>	<b>26</b>	<b>29</b>	<b>33</b>	
<b>bar</b>			<b>1,0</b>	<b>1,2</b>	<b>1,4</b>	<b>1,6</b>	<b>1,8</b>	<b>2,0</b>	<b>2,3</b>	
<b>MAX. LOAD kg</b>										
40 S			390	435	475	615	550			
<b>30 S</b>			485	540	590	640	<b>685</b>			
10 LT S			605	675	735	795	855	910	1170	
10 HT S			485	540	590	640	685			

According to availability

SIZE	Tread pattern	SW mm	OD mm	SLR mm	RC mm	SRI	Rim	Permitted Rims	Type	Tube
<b>9.5R20</b> 8 PR	<b>TM190</b>	245	937	436	2845	450	W8	W7 - W8H	TUBE TYPE	9.5-20 TR218
<b>PRESSURE</b>										<b>H</b>
<b>psi</b>			<b>20</b>	<b>23</b>	<b>26</b>	<b>29</b>	<b>35</b>	<b>41</b>	<b>49</b>	<b>52</b>
<b>bar</b>			<b>1,4</b>	<b>1,6</b>	<b>1,8</b>	<b>2,0</b>	<b>2,4</b>	<b>2,8</b>	<b>3,4</b>	<b>3,6</b>
<b>MAX. LOAD kg</b>										
40 S			520	560	600	640	715	780		
<b>30 S</b>			650	705	755	800	890	<b>975</b>		
10 LT S					940	1000	1115	1220	1365	1660
10 HT S			650	705	755	800	890	975		

According to availability

SIZE	Tread pattern	SW mm	OD mm	SLR mm	RC mm	SRI	Rim	Permitted Rims	Type	Tube	
<b>8.3R24</b> 8 PR	<b>TM190</b>	208	991	466	3010	475	W7	W6	TUBE TYPE	8.3-24 TR218	
<b>PRESSURE</b>										<b>H</b>	
				<b>psi</b>	<b>25</b>	<b>28</b>	<b>32</b>	<b>38</b>	<b>45</b>	<b>54</b>	<b>58</b>
				<b>bar</b>	<b>1,7</b>	<b>1,9</b>	<b>2,2</b>	<b>2,6</b>	<b>3,1</b>	<b>3,7</b>	<b>4,0</b>
<b>MAX. LOAD kg</b>											
40 S				530	565	615	675	750			
<b>30 S</b>				660	700	765	845	<b>935</b>			
10 LT S					885	965	1065	1180	1310	1590	
10 HT S				660	700	765	845	935			

According to availability

SIZE	Tread pattern	SW mm	OD mm	SLR mm	RC mm	SRI	Rim	Permitted Rims	Type	Tube				
<b>9.5R24</b> 107A8	<b>TM190</b>	245	1039	485	3140	500	W8	W7 - W8H - W9	TUBE TYPE	8.3-24 TR218				
<b>PRESSURE</b>										<b>H</b>				
				<b>psi</b>	<b>6</b>	<b>9</b>	<b>12</b>	<b>14</b>	<b>17</b>	<b>20</b>	<b>23</b>	<b>26</b>	<b>28</b>	<b>30</b>
				<b>bar</b>	<b>0,4</b>	<b>0,6</b>	<b>0,8</b>	<b>1,0</b>	<b>1,2</b>	<b>1,4</b>	<b>1,6</b>	<b>1,8</b>	<b>1,9</b>	<b>2,1</b>
<b>MAX. LOAD kg</b>														
50 S					585	645	705	770	830	900				
<b>40 S</b>					640	710	775	840	910	<b>975</b>				
30 S					690	760	835	905	980	1050				
10 LT S				780	875	965	1060	1150	1240	1340	1430	1470	1660	
10 HT S					690	760	835	905	980	1050				

According to availability

SIZE	Tread pattern	SW mm	OD mm	SLR mm	RC mm	SRI	Rim	Permitted Rims	Type	Tube				
<b>12.4R36</b> 124A8 (121B)	<b>TM190</b>	307	1446	671	4390	700	W11	W9 - W10 - DW10 DW11	TUBE TYPE	12.4-36 TR218				
<b>PRESSURE</b>										<b>H</b>				
				<b>psi</b>	<b>6</b>	<b>9</b>	<b>12</b>	<b>14</b>	<b>17</b>	<b>20</b>	<b>23</b>	<b>26</b>	<b>28</b>	<b>30</b>
				<b>bar</b>	<b>0,4</b>	<b>0,6</b>	<b>0,8</b>	<b>1,0</b>	<b>1,2</b>	<b>1,4</b>	<b>1,6</b>	<b>1,8</b>	<b>1,9</b>	<b>2,1</b>
<b>MAX. LOAD kg</b>														
50 S					960	1060	1160	1260	1360	1450				
<b>40 S</b>					1050	1160	1270	1380	1490	<b>1600</b>				
30 S					1130	1250	1370	1490	1600	1720				
10 LT S				1280	1430	1580	1730	1880	2030	2180	2330	2400	2720	
10 HT S					1130	1250	1370	1490	1600	1720				

For technical notes about pressure tables please refer to page 260.

## TM190

Radial tire for tractors





Specialized line for use on waterlogged and marshy terrain.

The extremely deep lugs, together with the structure of the carcass, provide high traction and flotation.

## SIZE

**380/85R38      139A8 (139B)**

**420/85R38      144A8 (144B)**

**460/85R38      149A8 (149B)**

SIZE	Tread pattern	SW mm	OD mm	SLR mm	RC mm	SRI	Rim	Permitted Rims	Type	Tube
<b>380/85R38</b> 139A8 (139B)	Marshland	405	1660	760	4970	775	W13	W11-W12-DW11 DW12-DW13	TUBELESS	16.9-38 TR218

### PRESSURE

psi	<b>12</b>	<b>14</b>	<b>17</b>	<b>20</b>	<b>23</b>	<b>26</b>	<b>29</b>
bar	<b>0,8</b>	<b>1,0</b>	<b>1,2</b>	<b>1,4</b>	<b>1,6</b>	<b>1,8</b>	<b>2,0</b>

### MAX. LOAD kg

50 S	1560	1775	1995	2215	2430		
<b>40 S</b>	1560	1775	1995	2215	<b>2430</b>		
30 S	1665	1900	2135	2370	2605		
10 LT S	2120	2415	2710	3010	3305	3475	3645
10 HT S	1665	1900	2135	2370	2605		

SIZE	Tread pattern	SW mm	OD mm	SLR mm	RC mm	SRI	Rim	Permitted Rims	Type	Tube
<b>420/85R38</b> 144A8 (144B)	Marshland	460	1745	795	5220	800	W15L	W14L-DW14L DW15L	TUBELESS	16.9-38 TR218

### PRESSURE

psi	<b>12</b>	<b>14</b>	<b>17</b>	<b>20</b>	<b>23</b>	<b>26</b>	<b>29</b>
bar	<b>0,8</b>	<b>1,0</b>	<b>1,2</b>	<b>1,4</b>	<b>1,6</b>	<b>1,8</b>	<b>2,0</b>

### MAX. LOAD kg

50 S	1795	2045	2300	2550	2800		
<b>40 S</b>	1795	2045	2300	2550	<b>2800</b>		
30 S	1920	2190	2460	2730	3000		
10 LT S	2440	2780	3125	3470	3810	4005	4200
10 HT S	1920	2190	2460	2730	3000		

SIZE	Tread pattern	SW mm	OD mm	SLR mm	RC mm	SRI	Rim	Permitted Rims	Type	Tube
<b>460/85R38</b> 149A8 (149B)	<b>Marshland</b>	499	1810	815	5420	825	W16L	W15L-DW15L DW16L	TUBELESS	18.4-38 TR218
<b>PRESSURE</b>										
<b>psi</b>			<b>12</b>	<b>14</b>	<b>17</b>	<b>20</b>	<b>23</b>	<b>26</b>	<b>29</b>	
<b>bar</b>			<b>0,8</b>	<b>1,0</b>	<b>1,2</b>	<b>1,4</b>	<b>1,6</b>	<b>1,8</b>	<b>2,0</b>	
<b>MAX. LOAD kg</b>										
50 S			2080	2375	2665	2960	3250			
<b>40 S</b>			2080	2375	2665	2960	<b>3250</b>			
30 S			2230	2540	2855	3165	3480			
10 LT S			2830	3230	3625	4025	4420	4650	4875	
10 HT S			2230	2540	2855	3165	3480			

For technical notes about pressure tables please refer to page 260.

## MARSHLAND

Radial tire for tractors



# TM300S



The particularly deep lugs and their special shape give the TM300S powerful grip which, along with the advantages of the radial construction, makes this tire suitable for all types of heavy work, on wet or difficult surfaces.

## SIZE

**13.6R36**

**127A8 (124B)**

SIZE	Tread pattern	SW mm	OD mm	SLR mm	RC mm	SRI	Rim	Permitted Rims	Type	Tube		
<b>13.6R36</b> 127A8 (124B)	<b>TM300S</b>	347	1510	698	4590	725	W12	W11 - DW11 DW12	TUBE TYPE	13.6-36 TR218		
<b>PRESSURE</b>										<b>H</b>		
<b>psi</b>			<b>6</b>	<b>9</b>	<b>12</b>	<b>14</b>	<b>17</b>	<b>20</b>	<b>23</b>	<b>26</b>	<b>28</b>	<b>30</b>
<b>bar</b>			<b>0,4</b>	<b>0,6</b>	<b>0,8</b>	<b>1,0</b>	<b>1,2</b>	<b>1,4</b>	<b>1,6</b>	<b>1,8</b>	<b>1,9</b>	<b>2,1</b>
<b>MAX. LOAD kg</b>												
50 S				1050	1160	1270	1380	1490	1600			
<b>40 S</b>				1150	1270	1390	1510	1630	<b>1750</b>			
30 S				1230	1360	1490	1620	1750	1880			
10 LT S			1400	1560	1730	1890	2060	2220	2390	2550	2630	2980
10 HT S				1230	1360	1490	1620	1750	1880			

According to availability

For technical notes about pressure tables please refer to page 260.

## TM300S



# TM90

The TM90 offers a complete range of sizes for tractors up to 160 hp. Engineered as a tubeless tire, the R-1 pattern can be used in a variety of applications, both in the field and on the road.



SIZE		
8-16 TT	6 PR	91A8 CN
8-18 TT	6 PR	94A8
8.3-20 TT	6 PR	96A8 CN
11.2-20 TT	8 PR	111A8
8.3-24 TT/TL	8 PR	105A8
9.5-24 TT/TL	8 PR	112A8
11.2-24 TT/TL	6 PR	110A8
12.4-24 TT/TL	8 PR	121A8
12.4-24 TL	12 PR	124A8 (128A6)
13.6-24 TT/TL	8 PR	123A8
14.9-24 TT/TL	8 PR	128A8
16.9-24 TT	8 PR	133A8
16.9-24 TL	12 PR	136A8 (140A6)
14.9-26 TL	8 PR	129A8
16.9-26 TL Harvester	10 PR	137A6
12.4-28 TT	8 PR	123A8
13.6-28 TT/TL	8 PR	125A8

SIZE		
13.6-28 TL	12 PR	130A8 (134A6)
14.9-28 TT/TL	8 PR	130A8
14.9-28 TL	12 PR	134A8 (138A6)
16.9-28 TL	8 PR	135A8
14.9-30 TL	8 PR	131A8
16.9-30 TT/TL	8 PR	137A8
18.4-30 TT/TL	8 PR	139A8
18.4-30 TL	12 PR	145A8 (149A6)
16.9-34 TT/TL	8 PR	139A8
18.4-34 TT/TL	8 PR	142A8
18.4-34 TL	12 PR	146A8 (151A6)
12.4-36 TT/TL	8 PR	127A8
12.4-36 TL	12 PR	131A8 (135A6)
15.5-38 TT/TL	8 PR	129A8
16.9-38 TT/TL	8 PR	141A8
18.4-38 TT	8 PR	143A8
18.4-38 TL	12 PR	149A8 (153A6)
20.8-38 TL	12 PR	152A8 (156A6)

## TM90

X-ply tire for tractors



SIZE	Tread pattern	SW mm	OD mm	SLR mm	RC mm	SRI	Rim	Permitted Rims	Type	Tube	
<b>8-16</b> 6 PR 91A8	<b>TM90</b>	209	795	370	2382		6L	6 L - 6 LB - 6.00 F	TT	7.50-16 TR15	
<b>PRESSURE</b>										<b>H</b>	
<b>psi</b>			<b>9</b>	<b>14</b>	<b>17</b>	<b>20</b>	<b>23</b>	<b>26</b>	<b>28</b>	<b>30</b>	<b>33</b>
<b>bar</b>			<b>0,6</b>	<b>1,0</b>	<b>1,2</b>	<b>1,4</b>	<b>1,6</b>	<b>1,8</b>	<b>1,9</b>	<b>2,1</b>	<b>2,3</b>
<b>MAX. LOAD kg</b>											
<b>40 S</b>			315	420	470	515	555	595	<b>615</b>		
30 S			335	450	505	550	595	635	660		
25 S			350	465	520	570	615	660	685		
10 LT S			470	605	665	720	775	825	850	900	1025
10 HT S			335	450	505	550	595	635	660		

SIZE	Tread pattern	SW mm	OD mm	SLR mm	RC mm	SRI	Rim	Permitted Rims	Type	Tube	
<b>8-18</b> 6 PR 94A8	<b>TM90</b>	209	845	393	2532		W6	W7-5.50 F	TT	7.50-18 TR15	
<b>PRESSURE</b>										<b>H</b>	
<b>psi</b>			<b>9</b>	<b>14</b>	<b>17</b>	<b>20</b>	<b>23</b>	<b>26</b>	<b>28</b>	<b>30</b>	<b>33</b>
<b>bar</b>			<b>0,6</b>	<b>1,0</b>	<b>1,2</b>	<b>1,4</b>	<b>1,6</b>	<b>1,8</b>	<b>1,9</b>	<b>2,1</b>	<b>2,3</b>
<b>MAX. LOAD kg</b>											
<b>40 S</b>			340	460	510	560	605	650	<b>670</b>		
30 S			365	490	545	600	645	695	715		
25 S			375	510	565	620	670	720	745		
10 LT S			510	660	725	785	845	900	925	980	1120
10 HT S			365	490	545	600	645	695	715		

SIZE	Tread pattern	SW mm	OD mm	SLR mm	RC mm	SRI	Rim	Permitted Rims	Type	Tube	
<b>8.3-20</b> 6 PR 96A8	<b>TM90</b>	209	898	418	2690		W7	W6	TT	7.50-20 TR15	
<b>PRESSURE</b>										<b>H</b>	
<b>psi</b>			<b>9</b>	<b>14</b>	<b>20</b>	<b>23</b>	<b>29</b>	<b>35</b>	<b>38</b>	<b>41</b>	<b>44</b>
<b>bar</b>			<b>0,6</b>	<b>1,0</b>	<b>1,4</b>	<b>1,6</b>	<b>2,0</b>	<b>2,4</b>	<b>2,6</b>	<b>2,8</b>	<b>3,0</b>
<b>MAX. LOAD kg</b>											
<b>40 S</b>			315	425	520	560	640	<b>710</b>			
30 S			335	455	555	600	685	760			
25 S			350	470	575	620	710	790			
10 LT S			475	605	720	770	870	960	1005	1045	1205
10 HT S			335	455	555	600	685	760			



SIZE	Tread pattern	SW mm	OD mm	SLR mm	RC mm	SRI	Rim	Permitted Rims	Type	Tube	
<b>11.2-20</b> 8 PR 111A8	<b>TM90</b>	299	1023	476	3092		W10	W9 - 9	TT	11.2-20 TR218A	
<b>PRESSURE</b>										<b>H</b>	
psi			<b>9</b>	<b>14</b>	<b>20</b>	<b>23</b>	<b>29</b>	<b>35</b>	<b>38</b>	<b>41</b>	<b>44</b>
bar			<b>0,6</b>	<b>1,0</b>	<b>1,4</b>	<b>1,6</b>	<b>2,0</b>	<b>2,4</b>	<b>2,6</b>	<b>2,8</b>	<b>3,0</b>
<b>MAX. LOAD kg</b>											
<b>40 S</b>			485	655	795	575	980	<b>1090</b>			
30 S			520	700	850	615	1050	1165			
25 S			540	725	880	640	1090	1210			
10 LT S			725	930	1105	830	1335	1475	1540	1605	1855
10 HT S			520	700	850	615	1050	1165			

SIZE	Tread pattern	SW mm	OD mm	SLR mm	RC mm	SRI	Rim	Permitted Rims	Type	Tube	
<b>8.3-24</b> 8 PR 105A8	<b>TM90</b>	209	992	478	3010	475	W7	W6	TT/TL		
<b>PRESSURE</b>										<b>H</b>	
psi			<b>17</b>	<b>23</b>	<b>29</b>	<b>35</b>	<b>41</b>	<b>45</b>	<b>49</b>	<b>54</b>	<b>55</b>
bar			<b>1,2</b>	<b>1,6</b>	<b>2,0</b>	<b>2,4</b>	<b>2,8</b>	<b>3,1</b>	<b>3,4</b>	<b>3,7</b>	<b>3,8</b>
<b>MAX. LOAD kg</b>											
<b>40 S</b>			530	630	715	795	870	<b>925</b>			
30 S			565	675	765	850	930	990			
25 S			590	700	795	880	965	1025			
10 LT S			750	875	985	1090	1185	1255	1325	1390	1555
10 HT S			565	675	765	850	930	990			

SIZE	Tread pattern	SW mm	OD mm	SLR mm	RC mm	SRI	Rim	Permitted Rims	Type	Tube	
<b>9.5-24</b> 8 PR 112A8	<b>TM90</b>	238	1050	502	3175	500	W8	W7	TT/TL		
<b>PRESSURE</b>										<b>H</b>	
psi			<b>12</b>	<b>17</b>	<b>23</b>	<b>29</b>	<b>35</b>	<b>41</b>	<b>46</b>	<b>49</b>	<b>51</b>
bar			<b>0,8</b>	<b>1,2</b>	<b>1,6</b>	<b>2,0</b>	<b>2,4</b>	<b>2,8</b>	<b>3,2</b>	<b>3,4</b>	<b>3,5</b>
<b>MAX. LOAD kg</b>											
<b>40 S</b>			540	680	805	920	1025	<b>1120</b>			
30 S			580	730	860	985	1095	1200			
25 S			600	755	895	1020	1140	1245			
10 LT S			780	960	1115	1255	1385	1510	1625	1680	1905
10 HT S			580	730	860	985	1095	1200			

## TM90

X-ply tire for tractors



SIZE	Tread pattern	SW mm	OD mm	SLR mm	RC mm	SRI	Rim	Permitted Rims	Type	Tube	
<b>11.2-24</b> 8 PR 116A8	<b>TM90</b>	295	1100	522	3325	550	W10	W9	TT/TL		
<b>PRESSURE</b>										<b>H</b>	
psi			<b>9</b>	<b>14</b>	<b>20</b>	<b>23</b>	<b>29</b>	<b>35</b>	<b>38</b>	<b>41</b>	<b>44</b>
bar			<b>0,6</b>	<b>1,0</b>	<b>1,4</b>	<b>1,6</b>	<b>2,0</b>	<b>2,4</b>	<b>2,6</b>	<b>2,8</b>	<b>3,0</b>
<b>MAX. LOAD kg</b>											
<b>40 S</b>			555	750	910	985	1125	<b>1250</b>			
30 S			595	805	975	1055	1205	1340			
25 S			615	835	1010	1095	1250	1390			
10 LT S			835	1065	1265	1360	1530	1690	1765	1840	2125
10 HT S			595	805	975	1055	1205	1340			

SIZE	Tread pattern	SW mm	OD mm	SLR mm	RC mm	SRI	Rim	Permitted Rims	Type	Tube	
<b>12.4-24</b> 8 PR 121A8	<b>TM90</b>	314	1160	545	3480	550	W11	W9 - W10	TT/TL		
<b>PRESSURE</b>										<b>H</b>	
psi			<b>9</b>	<b>14</b>	<b>20</b>	<b>23</b>	<b>29</b>	<b>33</b>	<b>36</b>	<b>39</b>	<b>41</b>
bar			<b>0,6</b>	<b>1,0</b>	<b>1,4</b>	<b>1,6</b>	<b>2,0</b>	<b>2,3</b>	<b>2,5</b>	<b>2,7</b>	<b>2,8</b>
<b>MAX. LOAD kg</b>											
<b>40 S</b>			660	890	1085	1175	1335	<b>1450</b>			
30 S			705	950	1160	1255	1430	1550			
25 S			735	990	1205	1305	1480	1610			
10 LT S			990	1275	1520	1635	1845	1990	2085	2175	2425
10 HT S			705	950	1160	1255	1430	1550			

SIZE	Tread pattern	SW mm	OD mm	SLR mm	RC mm	SRI	Rim	Permitted Rims	Type	Tube	
<b>12.4-24</b> 12 PR 124A8 (128A6)	<b>TM90</b>	322	1170	552	3520	550	W11	W9 - W10	TUBELESS		
<b>PRESSURE</b>										<b>H</b>	
psi			<b>9</b>	<b>16</b>	<b>25</b>	<b>32</b>	<b>41</b>	<b>48</b>	<b>52</b>	<b>58</b>	<b>60</b>
bar			<b>0,6</b>	<b>1,1</b>	<b>1,7</b>	<b>2,2</b>	<b>2,8</b>	<b>3,3</b>	<b>3,6</b>	<b>4,0</b>	<b>4,1</b>
<b>MAX. LOAD kg</b>											
<b>40 S</b>			590	840	1085	1260	1455	<b>1600</b>			
<b>30 S</b>			655	930	1205	1400	1615	<b>1800</b>			
25 S			720	1025	1325	1535	1775	1950			
10 LT S			885	1190	1500	1720	1965	2155	2260	2400	2710
10 HT S			655	930	1205	1400	1615	1800			

SIZE	Tread pattern	SW mm	OD mm	SLR mm	RC mm	SRI	Rim	Permitted Rims	Type	Tube	
<b>13.6-24</b> 8 PR 123A8	<b>TM90</b>	350	1210	570	3640	575	W12	W11	TT/TL		
<b>PRESSURE</b>										<b>H</b>	
psi			<b>9</b>	<b>14</b>	<b>20</b>	<b>23</b>	<b>26</b>	<b>29</b>	<b>32</b>	<b>35</b>	<b>36</b>
bar			<b>0,6</b>	<b>1,0</b>	<b>1,4</b>	<b>1,6</b>	<b>1,8</b>	<b>2,0</b>	<b>2,2</b>	<b>2,4</b>	<b>2,5</b>
<b>MAX. LOAD kg</b>											
<b>40 S</b>			765	1035	1260	1360	1455	<b>1550</b>			
30 S			820	1105	1350	1455	1555	1660			
25 S			850	1150	1400	1510	1615	1720			
10 LT S			1150	1470	1745	1870	1990	2105	2215	2325	2635
10 HT S			820	1105	1350	1455	1555	1660			

SIZE	Tread pattern	SW mm	OD mm	SLR mm	RC mm	SRI	Rim	Permitted Rims	Type	Tube	
<b>14.9-24</b> 8 PR 128A8	<b>TM90</b>	380	1270	594	3790	600	W13	W11 - W12	TUBELESS		
<b>PRESSURE</b>										<b>H</b>	
psi			<b>9</b>	<b>12</b>	<b>14</b>	<b>17</b>	<b>20</b>	<b>23</b>	<b>26</b>	<b>30</b>	<b>32</b>
bar			<b>0,6</b>	<b>0,8</b>	<b>1,0</b>	<b>1,2</b>	<b>1,4</b>	<b>1,6</b>	<b>1,8</b>	<b>2,1</b>	<b>2,2</b>
<b>MAX. LOAD kg</b>											
<b>40 S</b>			945	1120	1275	1420	1555	1680	<b>1800</b>		
30 S			1010	1200	1365	1520	1665	1800	1925		
25 S			1050	1245	1415	1575	1725	1865	2000		
10 LT S			1420	1630	1825	2005	2170	2330	2485	2700	3020
10 HT S			1010	1200	1365	1520	1665	1800	1925		

SIZE	Tread pattern	SW mm	OD mm	SLR mm	RC mm	SRI	Rim	Permitted Rims	Type	Tube	
<b>16.9-24</b> 8 PR 133A8	<b>TM90</b>	430	1334	620	3995	625	W15L	W14L	TT		
<b>PRESSURE</b>										<b>H</b>	
psi			<b>9</b>	<b>12</b>	<b>14</b>	<b>17</b>	<b>20</b>	<b>23</b>	<b>25</b>	<b>29</b>	<b>30</b>
bar			<b>0,6</b>	<b>0,8</b>	<b>1,0</b>	<b>1,2</b>	<b>1,4</b>	<b>1,6</b>	<b>1,7</b>	<b>2,0</b>	<b>2,1</b>
<b>MAX. LOAD kg</b>											
<b>40 S</b>			1120	1325	1510	1680	1840	1990	<b>2060</b>		
30 S			1200	1420	1615	1800	1970	2130	2205		
25 S			1245	1470	1675	1865	2040	2210	2285		
10 LT S			1680	1925	2150	2360	2555	2740	2830	3090	3480
10 HT S			1200	1420	1615	1800	1970	2130	2205		

## TM90

X-ply tire for tractors



SIZE	Tread pattern	SW mm	OD mm	SLR mm	RC mm	SRI	Rim	Permitted Rims	Type	Tube	
16.9-24 12 PR 136A8 (140A6)	TM90	445	1345	630	4025	625	W15L	W14L	TUBELESS		
	<b>PRESSURE</b> <span style="float: right;"><b>H</b></span>										
psi			<b>9</b>	<b>13</b>	<b>19</b>	<b>23</b>	<b>28</b>	<b>33</b>	<b>35</b>	<b>38</b>	<b>39</b>
bar			<b>0,6</b>	<b>0,9</b>	<b>1,3</b>	<b>1,6</b>	<b>1,9</b>	<b>2,3</b>	<b>2,4</b>	<b>2,6</b>	<b>2,7</b>
<b>MAX. LOAD kg</b>											
<b>40 S</b>			1020	1295	1605	1810	2005	<b>2240</b>			
<b>30 S</b>			1130	1435	1780	2010	2225	<b>2500</b>			
25 S			1245	1580	1960	2210	2445	2735			
10 LT S			1530	1870	2260	2525	2770	3075	3150	3290	3360
10 HT S			1130	1435	1780	2010	2225	2485			

SIZE	Tread pattern	SW mm	OD mm	SLR mm	RC mm	SRI	Rim	Permitted Rims	Type	Tube	
14.9-26 8 PR 129A8	TM90	376	1315	612	3940	625	W13	W11 - W12	TUBELESS		
	<b>PRESSURE</b> <span style="float: right;"><b>H</b></span>										
psi			<b>9</b>	<b>12</b>	<b>14</b>	<b>17</b>	<b>20</b>	<b>23</b>	<b>26</b>	<b>30</b>	<b>32</b>
bar			<b>0,6</b>	<b>0,8</b>	<b>1,0</b>	<b>1,2</b>	<b>1,4</b>	<b>1,6</b>	<b>1,8</b>	<b>2,1</b>	<b>2,2</b>
<b>MAX. LOAD kg</b>											
<b>40 S</b>			975	1150	1310	1460	1595	1725	<b>1850</b>		
30 S			1045	1230	1400	1560	1705	1845	1980		
25 S			1080	1275	1455	1620	1770	1915	2055		
10 LT S			1460	1675	1875	2060	2230	2395	2550	2775	3105
10 HT S			1045	1230	1400	1560	1705	1845	1980		

SIZE	Tread pattern	SW mm	OD mm	SLR mm	RC mm	SRI	Rim	Permitted Rims	Type	Tube	
16.9-26 10 PR 137A6	TM90 Harvester	430	1385	645	4140	650	DW15L		TUBELESS		
	<b>PRESSURE</b> <span style="float: right;"><b>H</b></span>										
psi			<b>9</b>	<b>14</b>	<b>20</b>	<b>23</b>	<b>26</b>	<b>29</b>	<b>32</b>	<b>35</b>	<b>36</b>
bar			<b>0,6</b>	<b>1,0</b>	<b>1,4</b>	<b>1,6</b>	<b>1,8</b>	<b>2,0</b>	<b>2,2</b>	<b>2,4</b>	<b>2,5</b>
<b>MAX. LOAD kg</b>											
40 S			1020	1380	1680	1820	1950	2070			
<b>30 S</b>			1135	1535	1865	2020	2165	<b>2300</b>			
20 S			1360	1840	2240	2425	2600	2760			
10 LT S			1395	1885	2295	2480	2655	2825	2990	3145	3220
10 HT S			1215	1640	1995	2160	2315	2460			
10 Cyc S			1695	2290	2785	3010	3225	3430	3630	3820	3910

**Design data** = the dimensions of size in design data are calculated dimensions and not measured data on the normal production tire

SIZE	Tread pattern	SW mm	OD mm	SLR mm	RC mm	SRI	Rim	Permitted Rims	Type	Tube	
<b>12.4-28</b> 8 PR 123A8	<b>TM90</b>	325	1253	583	3759	600	W11	W10 - W9	TUBETYPE	12.4-28 TR218A	
<b>PRESSURE</b>										<b>H</b>	
psi			<b>9</b>	<b>14</b>	<b>20</b>	<b>23</b>	<b>29</b>	<b>33</b>	<b>36</b>	<b>39</b>	<b>41</b>
bar			<b>0,6</b>	<b>1,0</b>	<b>1,4</b>	<b>1,6</b>	<b>2,0</b>	<b>2,3</b>	<b>2,5</b>	<b>2,7</b>	<b>2,8</b>
<b>MAX. LOAD kg</b>											
<b>40 S</b>			705	835	1160	1255	1430	<b>1550</b>			
30 S			755	895	1240	1345	1530	1660			
25 S			785	925	1290	1395	1585	1720			
10 LT S			1060	1220	1625	1745	1970	2130	2230	2325	2595
10 HT S			755	895	1240	1345	1530	1660			

SIZE	Tread pattern	SW mm	OD mm	SLR mm	RC mm	SRI	Rim	Permitted Rims	Type	Tube	
<b>13.6-28</b> 8 PR 125A8	<b>TM90</b> <b>Harvester</b>	345	1305	645	3910	625	W12		TT/TL		
<b>PRESSURE</b>										<b>H</b>	
psi			<b>9</b>	<b>14</b>	<b>20</b>	<b>23</b>	<b>26</b>	<b>29</b>	<b>32</b>	<b>35</b>	<b>36</b>
bar			<b>0,6</b>	<b>1,0</b>	<b>1,4</b>	<b>1,6</b>	<b>1,8</b>	<b>2,0</b>	<b>2,2</b>	<b>2,4</b>	<b>2,5</b>
<b>MAX. LOAD kg</b>											
<b>40 S</b>			815	1100	1340	1450	1550	<b>1650</b>			
30 S			870	1175	1435	1550	1660	1765			
25 S			905	1220	1485	1610	1720	1830			
10 LT S			1225	1565	1855	1990	2120	2240	2360	2475	2805
10 HT S			870	1175	1435	1550	1660	1765			

**Design data** = the dimensions of size in design data are calculated dimensions and not measured data on the normal production tire

SIZE	Tread pattern	SW mm	OD mm	SLR mm	RC mm	SRI	Rim	Permitted Rims	Type	Tube	
<b>13.6-28</b> 12 PR 130A8 (134A6)	<b>TM90</b>	350	1305	612	3910	625	W12		TUBELESS		
<b>PRESSURE</b>										<b>H</b>	
psi			<b>9</b>	<b>16</b>	<b>22</b>	<b>28</b>	<b>33</b>	<b>42</b>	<b>46</b>	<b>49</b>	<b>52</b>
bar			<b>0,6</b>	<b>1,1</b>	<b>1,5</b>	<b>1,9</b>	<b>2,3</b>	<b>2,9</b>	<b>3,2</b>	<b>3,4</b>	<b>3,6</b>
<b>MAX. LOAD kg</b>											
<b>40 S</b>			755	1080	1290	1485	1660	<b>1900</b>			
<b>30 S</b>			840	1200	1430	1650	1845	<b>2120</b>			
25 S			920	1320	1575	1810	2025	2320			
10 LT S			1135	1525	1795	2035	2260	2565	2710	2805	3215
10 HT S			840	1200	1430	1650	1845	2110			

## TM90

X-ply tire for tractors



SIZE	Tread pattern	SW mm	OD mm	SLR mm	RC mm	SRI	Rim	Permitted Rims	Type	Tube	
<b>14.9-28</b> 8 PR 130A8	<b>TM90</b>	380	1360	630	4050	650	W13	W11 - W12	TT/TL		
<b>PRESSURE</b>										<b>H</b>	
<b>psi</b>			<b>9</b>	<b>12</b>	<b>14</b>	<b>17</b>	<b>20</b>	<b>23</b>	<b>26</b>	<b>30</b>	<b>32</b>
<b>bar</b>			<b>0,6</b>	<b>0,8</b>	<b>1,0</b>	<b>1,2</b>	<b>1,4</b>	<b>1,6</b>	<b>1,8</b>	<b>2,1</b>	<b>2,2</b>
<b>MAX. LOAD kg</b>											
<b>40 S</b>			1000	1180	1345	1500	1640	1775	<b>1900</b>		
30 S			1070	1265	1440	1605	1755	1900	2035		
25 S			1110	1310	1495	1665	1820	1970	2110		
10 LT S			1500	1720	1925	2115	2290	2460	2620	2850	3190
10 HT S			1070	1265	1440	1605	1755	1900	2035		

SIZE	Tread pattern	SW mm	OD mm	SLR mm	RC mm	SRI	Rim	Permitted Rims	Type	Tube	
<b>14.9-28</b> 12 PR 134A8 (138A6)	<b>TM90</b>	385	1370	640	4095	650	W13	W11 - W12	TUBELESS		
<b>PRESSURE</b>										<b>H</b>	
<b>psi</b>			<b>9</b>	<b>13</b>	<b>19</b>	<b>25</b>	<b>30</b>	<b>38</b>	<b>42</b>	<b>45</b>	<b>46</b>
<b>bar</b>			<b>0,6</b>	<b>0,9</b>	<b>1,3</b>	<b>1,7</b>	<b>2,1</b>	<b>2,6</b>	<b>2,9</b>	<b>3,1</b>	<b>3,2</b>
<b>MAX. LOAD kg</b>											
<b>40 S</b>			900	1140	1415	1655	1870	<b>2120</b>			
<b>30 S</b>			1000	1265	1570	1835	2075	<b>2360</b>			
25 S			1100	1390	1725	2020	2280	2585			
10 LT S			1350	1640	1985	2285	2565	2885	3065	3180	3570
10 HT S			1000	1265	1570	1835	2075	2355			

SIZE	Tread pattern	SW mm	OD mm	SLR mm	RC mm	SRI	Rim	Permitted Rims	Type	Tube	
<b>16.9-28</b> 8 PR 135A8	<b>TM90</b>	435	1435	660	4285	675	W15		TUBELESS		
<b>PRESSURE</b>										<b>H</b>	
<b>psi</b>			<b>9</b>	<b>12</b>	<b>14</b>	<b>17</b>	<b>20</b>	<b>23</b>	<b>25</b>	<b>29</b>	<b>30</b>
<b>bar</b>			<b>0,6</b>	<b>0,8</b>	<b>1,0</b>	<b>1,2</b>	<b>1,4</b>	<b>1,6</b>	<b>1,7</b>	<b>2,0</b>	<b>2,1</b>
<b>MAX. LOAD kg</b>											
<b>40 S</b>			1185	1405	1600	1780	1945	2105	<b>2180</b>		
30 S			1270	1505	1710	1905	2080	2250	2335		
25 S			1315	1560	1775	1975	2160	2335	2420		
10 LT S			1780	2035	2275	2495	2705	2900	2995	3270	3680
10 HT S			1270	1505	1710	1905	2080	2250	2335		

SIZE	Tread pattern	SW mm	OD mm	SLR mm	RC mm	SRI	Rim	Permitted Rims	Type	Tube	
<b>14.9-30</b> 8 PR 131A8	<b>TM90</b>	377	1416	652	4210	675	W13L	W11 - W12	TUBELESS		
<b>PRESSURE</b>										<b>H</b>	
<b>psi</b>			<b>9</b>	<b>12</b>	<b>14</b>	<b>17</b>	<b>20</b>	<b>23</b>	<b>26</b>	<b>30</b>	<b>32</b>
<b>bar</b>			<b>0,6</b>	<b>0,8</b>	<b>1,0</b>	<b>1,2</b>	<b>1,4</b>	<b>1,6</b>	<b>1,8</b>	<b>2,1</b>	<b>2,2</b>
<b>MAX. LOAD kg</b>											
<b>40 S</b>			1025	1215	1385	1540	1685	1820	<b>1950</b>		
30 S			1095	1300	1480	1650	1805	1945	2085		
25 S			1140	1350	1535	1710	1870	2020	2165		
10 LT S			1540	1765	1975	2170	2350	2525	2690	2925	3270
10 HT S			1095	1300	1480	1650	1805	1945	2085		

SIZE	Tread pattern	SW mm	OD mm	SLR mm	RC mm	SRI	Rim	Permitted Rims	Type	Tube	
<b>16.9-30</b> 8 PR 137A8	<b>TM90</b>	430	1485	685	4455	700	W15L	W14L	TT/TL		
<b>PRESSURE</b>										<b>H</b>	
<b>psi</b>			<b>9</b>	<b>12</b>	<b>14</b>	<b>17</b>	<b>20</b>	<b>23</b>	<b>25</b>	<b>29</b>	<b>30</b>
<b>bar</b>			<b>0,6</b>	<b>0,8</b>	<b>1,0</b>	<b>1,2</b>	<b>1,4</b>	<b>1,6</b>	<b>1,7</b>	<b>2,0</b>	<b>2,1</b>
<b>MAX. LOAD kg</b>											
<b>40 S</b>			1250	1480	1685	1875	2055	2220	<b>2300</b>		
30 S			1340	1585	1805	2005	2200	2375	2460		
25 S			1390	1645	1870	2080	2280	2465	2555		
10 LT S			1875	2150	2400	2635	2855	3060	3160	3450	3885
10 HT S			1340	1585	1805	2005	2200	2375	2460		

SIZE	Tread pattern	SW mm	OD mm	SLR mm	RC mm	SRI	Rim	Permitted Rims	Type	Tube
<b>18.4-30</b> 8 PR 139A8	<b>TM90</b>	464	1548	710	4635	725	W16L	W15L	TT/TL	
<b>PRESSURE</b>										<b>H</b>
<b>psi</b>			<b>9</b>	<b>12</b>	<b>14</b>	<b>17</b>	<b>19</b>	<b>20</b>	<b>23</b>	<b>25</b>
<b>bar</b>			<b>0,6</b>	<b>0,8</b>	<b>1,0</b>	<b>1,2</b>	<b>1,3</b>	<b>1,4</b>	<b>1,6</b>	<b>1,7</b>
<b>MAX. LOAD kg</b>										
<b>40 S</b>			1480	1750	1995	2220	2325	<b>2430</b>		
30 S			1585	1875	2135	2375	2490	2600		
25 S			1645	1945	2215	2465	2580	2695		
10 LT S			2220	2550	2850	3130	3265	3395	3645	4060
10 HT S			1585	1875	2135	2375	2490	2600		

## TM90

X-ply tire for tractors



SIZE	Tread pattern	SW mm	OD mm	SLR mm	RC mm	SRI	Rim	Permitted Rims	Type	Tube	
<b>18.4-30</b> 12 PR 145A8 (149A6)	<b>TM90</b>	472	1560	725	4665	725	W16L	W15L	TUBELESS		
<b>PRESSURE</b>										<b>H</b>	
psi			<b>9</b>	<b>13</b>	<b>19</b>	<b>23</b>	<b>28</b>	<b>32</b>	<b>35</b>	<b>38</b>	<b>39</b>
bar			<b>0,6</b>	<b>0,9</b>	<b>1,3</b>	<b>1,6</b>	<b>1,9</b>	<b>2,2</b>	<b>2,4</b>	<b>2,6</b>	<b>2,7</b>
<b>MAX. LOAD kg</b>											
<b>40 S</b>			1355	1720	2130	2405	2660	<b>2900</b>			
<b>30 S</b>			1505	1910	2365	2670	2955	<b>3250</b>			
25 S			1655	2100	2600	2935	3245	3540			
10 LT S			2035	2475	2990	3340	3665	3970	4160	4350	4875
10 HT S			1505	1910	2365	2670	2955	3250			

SIZE	Tread pattern	SW mm	OD mm	SLR mm	RC mm	SRI	Rim	Permitted Rims	Type	Tube	
<b>16.9-34</b> 8 PR 139A8	<b>TM90</b>	430	1583	728	4760	750	W15L	W14L	TT/TL		
<b>PRESSURE</b>										<b>H</b>	
psi			<b>9</b>	<b>12</b>	<b>14</b>	<b>17</b>	<b>20</b>	<b>23</b>	<b>25</b>	<b>29</b>	<b>30</b>
bar			<b>0,6</b>	<b>0,8</b>	<b>1,0</b>	<b>1,2</b>	<b>1,4</b>	<b>1,6</b>	<b>1,7</b>	<b>2,0</b>	<b>2,1</b>
<b>MAX. LOAD kg</b>											
<b>40 S</b>			1320	1565	1780	1980	2170	2345	<b>2430</b>		
30 S			1410	1675	1905	2120	2320	2510	2600		
25 S			1465	1735	1975	2200	2410	2605	2695		
10 LT S			1980	2270	2535	2780	3015	3235	3340	3645	4100
10 HT S			1410	1675	1905	2120	2320	2510	2600		

SIZE	Tread pattern	SW mm	OD mm	SLR mm	RC mm	SRI	Rim	Permitted Rims	Type	Tube	
<b>18.4-34</b> 8 PR 142A8	<b>TM90</b>	470	1650	752	4935	775	W16L	W15L	TT/TL		
<b>PRESSURE</b>										<b>H</b>	
psi			<b>9</b>	<b>12</b>	<b>14</b>	<b>17</b>	<b>19</b>	<b>20</b>	<b>23</b>	<b>25</b>	
bar			<b>0,6</b>	<b>0,8</b>	<b>1,0</b>	<b>1,2</b>	<b>1,3</b>	<b>1,4</b>	<b>1,6</b>	<b>1,7</b>	
<b>MAX. LOAD kg</b>											
<b>40 S</b>			1615	1910	2175	2420	2540	<b>2650</b>			
30 S			1730	2045	2325	2590	2720	2835			
25 S			1795	2120	2415	2685	2820	2940			
10 LT S			2420	2780	3110	3415	3560	3705	3975	4430	
10 HT S			1730	2045	2325	2590	2720	2835			



SIZE	Tread pattern	SW mm	OD mm	SLR mm	RC mm	SRI	Rim	Permitted Rims	Type	Tube	
<b>18.4-34</b> 12 PR 146A8 (151A6)	<b>TM90</b>	475	1660	768	4965	775	W16L	W15L	TUBELESS		
<b>PRESSURE</b>										<b>H</b>	
psi			<b>9</b>	<b>13</b>	<b>19</b>	<b>23</b>	<b>28</b>	<b>32</b>	<b>35</b>	<b>38</b>	<b>39</b>
bar			<b>0,6</b>	<b>0,9</b>	<b>1,3</b>	<b>1,6</b>	<b>1,9</b>	<b>2,2</b>	<b>2,4</b>	<b>2,6</b>	<b>2,7</b>
<b>MAX. LOAD kg</b>											
<b>40 S</b>			1405	1780	2205	2490	2755	<b>3000</b>			
<b>30 S</b>			1560	1975	2450	2765	3060	<b>3450</b>			
25 S			1715	2170	2690	3040	3360	3660			
10 LT S			2105	2560	3095	3455	3790	4105	4305	4500	5045
10 HT S			1560	1975	2450	2765	3060	3330			

SIZE	Tread pattern	SW mm	OD mm	SLR mm	RC mm	SRI	Rim	Permitted Rims	Type	Tube	
<b>12.4-36</b> 8 PR 127A8	<b>TM90</b>	318	1458	678	4385	700	W11	W9 - W10	TT/TL		
<b>PRESSURE</b>										<b>H</b>	
psi			<b>9</b>	<b>14</b>	<b>20</b>	<b>23</b>	<b>29</b>	<b>33</b>	<b>36</b>	<b>39</b>	<b>41</b>
bar			<b>0,6</b>	<b>1,0</b>	<b>1,4</b>	<b>1,6</b>	<b>2,0</b>	<b>2,3</b>	<b>2,5</b>	<b>2,7</b>	<b>2,8</b>
<b>MAX. LOAD kg</b>											
<b>40 S</b>			795	1075	1310	1415	1615	<b>1750</b>			
30 S			850	1150	1400	1515	1730	1875			
25 S			880	1195	1455	1570	1795	1945			
10 LT S			1195	1540	1835	1970	2225	2400	2515	2625	2930
10 HT S			850	1150	1400	1515	1730	1875			

SIZE	Tread pattern	SW mm	OD mm	SLR mm	RC mm	SRI	Rim	Permitted Rims	Type	Tube	
<b>12.4-36</b> 12 PR 131A8 (135A6)	<b>TM90</b>	318	1475	686	4395	700	W11	W9 - W10	TUBELESS		
<b>PRESSURE</b>										<b>H</b>	
psi			<b>9</b>	<b>16</b>	<b>25</b>	<b>32</b>	<b>41</b>	<b>48</b>	<b>52</b>	<b>56</b>	<b>60</b>
bar			<b>0,6</b>	<b>1,1</b>	<b>1,7</b>	<b>2,2</b>	<b>2,8</b>	<b>3,3</b>	<b>3,6</b>	<b>3,9</b>	<b>4,1</b>
<b>MAX. LOAD kg</b>											
<b>40 S</b>			720	1025	1325	1540	1770	<b>1950</b>			
<b>30 S</b>			800	1140	1470	1710	1965	<b>2180</b>			
25 S			880	1250	1615	1880	2160	2380			
10 LT S			1080	1450	1825	2100	2395	2625	2755	2885	3305
10 HT S			800	1140	1470	1710	1965	2180			

## TM90

X-ply tire for tractors



SIZE	Tread pattern	SW mm	OD mm	SLR mm	RC mm	SRI	Rim	Permitted Rims	Type	Tube	
<b>15.5-38</b> 8 PR 129A8	<b>TM90</b>	390	1580	725	4700	750	W14L		TT/TL		
<b>PRESSURE</b>										<b>H</b>	
psi			<b>9</b>	<b>12</b>	<b>14</b>	<b>17</b>	<b>20</b>	<b>23</b>	<b>26</b>	<b>30</b>	<b>32</b>
bar			<b>0,6</b>	<b>0,8</b>	<b>1,0</b>	<b>1,2</b>	<b>1,4</b>	<b>1,6</b>	<b>1,8</b>	<b>2,1</b>	<b>2,2</b>
<b>MAX. LOAD kg</b>											
<b>40 S</b>			975	1150	1310	1460	1595	1725	<b>1850</b>		
30 S			1045	1230	1400	1560	1705	1845	1980		
25 S			1080	1275	1455	1620	1770	1915	2055		
10 LT S			1460	1675	1875	2060	2230	2395	2550	2775	3105
10 HT S			1045	1230	1400	1560	1705	1845	1980		

SIZE	Tread pattern	SW mm	OD mm	SLR mm	RC mm	SRI	Rim	Permitted Rims	Type	Tube	
<b>16.9-38</b> 8 PR 141A8	<b>TM90</b>	436	1688	766	5000	800	W15L	W14L	TT/TL		
<b>PRESSURE</b>										<b>H</b>	
psi			<b>9</b>	<b>12</b>	<b>14</b>	<b>17</b>	<b>20</b>	<b>23</b>	<b>25</b>	<b>29</b>	<b>30</b>
bar			<b>0,6</b>	<b>0,8</b>	<b>1,0</b>	<b>1,2</b>	<b>1,4</b>	<b>1,6</b>	<b>1,7</b>	<b>2,0</b>	<b>2,1</b>
<b>MAX. LOAD kg</b>											
<b>40 S</b>			1400	1655	1890	2100	2300	2485	<b>2575</b>		
30 S			1500	1770	2020	2245	2460	2660	2755		
25 S			1555	1835	2100	2330	2555	2760	2860		
10 LT S			2100	2405	2685	2950	3195	3425	3540	3865	4345
10 HT S			1500	1770	2020	2245	2460	2660	2755		

SIZE	Tread pattern	SW mm	OD mm	SLR mm	RC mm	SRI	Rim	Permitted Rims	Type	Tube
<b>18.4-38</b> 8 PR 143A8	<b>TM90</b>	470	1750	792	5200	825	W16L	W15L	TUBETYPE	
<b>PRESSURE</b>										<b>H</b>
psi			<b>9</b>	<b>12</b>	<b>14</b>	<b>17</b>	<b>19</b>	<b>20</b>	<b>23</b>	<b>25</b>
bar			<b>0,6</b>	<b>0,8</b>	<b>1,0</b>	<b>1,2</b>	<b>1,3</b>	<b>1,4</b>	<b>1,6</b>	<b>1,7</b>
<b>MAX. LOAD kg</b>										
<b>40 S</b>			1660	1965	2240	2490	2610	<b>2725</b>		
30 S			1775	2105	2395	2665	2795	2915		
25 S			1845	2180	2485	2765	2895	3025		
10 LT S			2490	2860	3195	3510	3660	3805	4090	4555
10 HT S			1775	2105	2395	2665	2795	2915		

SIZE	Tread pattern	SW mm	OD mm	SLR mm	RC mm	SRI	Rim	Permitted Rims	Type	Tube	
<b>18.4-38</b> 12 PR 149A8 (153A6)	<b>TM90</b>	480	1770	816	5290	825	W16L	W15L	TUBELESS		
<b>PRESSURE</b>										<b>H</b>	
<b>psi</b>			<b>9</b>	<b>13</b>	<b>19</b>	<b>23</b>	<b>28</b>	<b>32</b>	<b>35</b>	<b>38</b>	<b>39</b>
<b>bar</b>			<b>0,6</b>	<b>0,9</b>	<b>1,3</b>	<b>1,6</b>	<b>1,9</b>	<b>2,2</b>	<b>2,4</b>	<b>2,6</b>	<b>2,7</b>
<b>MAX. LOAD kg</b>											
<b>40 S</b>			1520	1925	2390	2700	2985	<b>3250</b>			
<b>30 S</b>			1685	2135	2655	2995	3315	<b>3650</b>			
25 S			1855	2350	2915	3295	3640	3965			
10 LT S			2280	2775	3350	3740	4105	4445	4665	4875	5465
10 HT S			1685	2135	2655	2995	3315	3610			

SIZE	Tread pattern	SW mm	OD mm	SLR mm	RC mm	SRI	Rim	Permitted Rims	Type	Tube	
<b>20.8-38</b> 12 PR 152A8 (156A6)	<b>TM90</b>	555	1845	850	5520	875	W18L	W16L	TUBELESS		
<b>PRESSURE</b>										<b>H</b>	
<b>psi</b>			<b>9</b>	<b>13</b>	<b>19</b>	<b>22</b>	<b>25</b>	<b>28</b>	<b>30</b>	<b>32</b>	<b>33</b>
<b>bar</b>			<b>0,6</b>	<b>0,9</b>	<b>1,3</b>	<b>1,5</b>	<b>1,7</b>	<b>1,9</b>	<b>2,1</b>	<b>2,2</b>	<b>2,3</b>
<b>MAX. LOAD kg</b>											
<b>40 S</b>			1810	2295	2845	3090	3325	<b>3550</b>			
<b>30 S</b>			2010	2545	3160	3430	3690	<b>4000</b>			
25 S			2210	2800	3470	3770	4055	4330			
10 LT S			2715	3310	4005	4325	4625	4915	5190	5325	5925
10 HT S			2010	2545	3160	3430	3690	4000			

For technical notes about pressure tables please refer to page 260.

## TM90

X-ply tire for tractors



# TD27



The tread pattern of the TD27 allows maximum use of this tire in both field and road operations.

SIZE		
<b>4.00-15</b>	<b>4 PR</b>	<b>(66A6)</b>
<b>5.00-15</b>	<b>6 PR</b>	<b>(82A6)</b>
<b>5.50-16</b>	<b>6 PR</b>	<b>(86A6)</b>
<b>6.00-16</b>	<b>8 PR</b>	<b>(94A6)</b>

SIZE		
<b>6.50-16</b>	<b>8 PR</b>	<b>(98A6)</b>
<b>7.50-16</b>	<b>8 PR</b>	<b>(103A6)</b>
<b>7.50-16</b>	<b>10 PR</b>	<b>(109A6)</b>
<b>4.00/4.50-21</b>	<b>4 PR</b>	

SIZE	Tread pattern	SW mm	OD mm	SLR mm	RC mm	Rims	Tube
<b>4.00-15 4 PR (66A6)</b>	<b>TD27</b>	118	618	291	1883	3.00Dx15	4.00-15/125-15 TR13

### PRESSURE

psi	<b>26</b>	<b>29</b>	<b>32</b>	<b>35</b>	<b>38</b>	<b>41</b>	<b>43</b>	<b>46</b>	<b>49</b>
bar	<b>1,8</b>	<b>2,0</b>	<b>2,2</b>	<b>2,4</b>	<b>2,6</b>	<b>2,8</b>	<b>3,0</b>	<b>3,2</b>	<b>3,4</b>

### MAX. LOAD kg

25	240	255	270	280	295	310	320	335	345
<b>30</b>	205	220	235	245	255	270	280	290	<b>300</b>
35	185	200	210	220	230	240	250	260	270
40	165	175	185	195	205	215	225	230	240
F									450

SIZE	Tread pattern	SW mm	OD mm	SLR mm	RC mm	Rims	Tube
<b>5.00-15 6 PR (82A6)</b>	<b>TD27</b>	145	660	311	2022	4Jx15	155/165R15 TR15

### PRESSURE

psi	<b>26</b>	<b>29</b>	<b>32</b>	<b>35</b>	<b>38</b>	<b>41</b>	<b>43</b>	<b>46</b>	<b>49</b>	<b>54</b>	<b>67</b>
bar	<b>1,8</b>	<b>2,0</b>	<b>2,2</b>	<b>2,4</b>	<b>2,6</b>	<b>2,8</b>	<b>3,0</b>	<b>3,2</b>	<b>3,4</b>	<b>3,7</b>	<b>4,6</b>

### MAX. LOAD kg

25	360	380	405	425	445	465	485	500	520	545
<b>30</b>	310	330	350	370	385	405	420	435	450	<b>475</b>
35		300	315	330	345	365	380	390	405	430
40	250	265	280	295	310	325	335	350	360	380
F										710
Loader										945

SIZE	Tread pattern	SW mm	OD mm	SLR mm	RC mm	Rims						Tube
5.50-16 6 PR (86A6)	TD27	155	719	330	2164	4.00Ex16						5.00/5.50-16 TR15
<b>PRESSURE</b>												
psi		<b>26</b>	<b>29</b>	<b>32</b>	<b>35</b>	<b>38</b>	<b>41</b>	<b>43</b>	<b>46</b>	<b>49</b>	<b>54</b>	<b>67</b>
bar		<b>1,8</b>	<b>2,0</b>	<b>2,2</b>	<b>2,4</b>	<b>2,6</b>	<b>2,8</b>	<b>3,0</b>	<b>3,2</b>	<b>3,4</b>	<b>3,7</b>	<b>4,6</b>
<b>MAX. LOAD kg</b>												
25		400	425	450	475	495	520	540	560	580	610	
<b>30</b>		350	370	390	410	430	450	470	485	505	<b>530</b>	
35		315	335	350	370	390	405	420	440	455	475	
40		280	295	315	330	345	360	375	390	405	425	
F												790
Loader												1055

SIZE	Tread pattern	SW mm	OD mm	SLR mm	RC mm	Rims						Tube					
6.00-16 8 PR (94A6)	TD27	172	738	349	2256	4.50Ex16						6.00-16 TR15					
<b>PRESSURE</b>																	
psi		<b>26</b>	<b>29</b>	<b>32</b>	<b>35</b>	<b>38</b>	<b>41</b>	<b>43</b>	<b>46</b>	<b>49</b>	<b>52</b>	<b>55</b>	<b>58</b>	<b>61</b>	<b>64</b>	<b>65</b>	<b>81</b>
bar		<b>1,8</b>	<b>2,0</b>	<b>2,2</b>	<b>2,4</b>	<b>2,6</b>	<b>2,8</b>	<b>3,0</b>	<b>3,2</b>	<b>3,4</b>	<b>3,6</b>	<b>3,8</b>	<b>4,0</b>	<b>4,2</b>	<b>4,4</b>	<b>4,5</b>	<b>5,6</b>
<b>MAX. LOAD kg</b>																	
25		450	480	505	535	560	585	610	630	655	675	700	720	740	760	770	
<b>30</b>		390	415	440	465	485	510	530	550	570	590	605	625	645	660	<b>670</b>	
35		355	375	395	420	435	455	475	495	510	530	545	565	580	595	605	
40		315	335	355	370	390	405	425	440	455	470	485	500	515	530	535	
F																	1000
Loader																	1335

SIZE	Tread pattern	SW mm	OD mm	SLR mm	RC mm	Rims						Tube				
6.50-16 8 PR (98A6)	TD27	180	759	353	2290	4.50Ex16						6.50/7.00-16 TR15				
<b>PRESSURE</b>																
psi		<b>26</b>	<b>29</b>	<b>32</b>	<b>35</b>	<b>38</b>	<b>41</b>	<b>43</b>	<b>46</b>	<b>49</b>	<b>52</b>	<b>55</b>	<b>58</b>	<b>61</b>	<b>75</b>	
bar		<b>1,8</b>	<b>2,0</b>	<b>2,2</b>	<b>2,4</b>	<b>2,6</b>	<b>2,8</b>	<b>3,0</b>	<b>3,2</b>	<b>3,4</b>	<b>3,6</b>	<b>3,8</b>	<b>4,0</b>	<b>4,2</b>	<b>5,2</b>	
<b>MAX. LOAD kg</b>																
25		525	560	590	620	650	680	710	735	760	790	815	840	865		
<b>30</b>		455	485	515	540	565	590	615	640	665	685	705	730	<b>750</b>		
35		410	435	465	485	510	535	555	575	595	615	635	655	675		
40		365	390	410	435	455	475	495	510	530	550	565	585	600		
F																1120
Loader																1490

## TD27

X-ply tire for tractors



SIZE	Tread pattern	SW mm	OD mm	SLR mm	RC mm	Rims						Tube		
7.50-16 8 PR (103A6)	TD27	218	803	372	2432	5.50Fx16						6.50/7.00-16 TR15		
<b>PRESSURE</b>														
psi		<b>26</b>	<b>29</b>	<b>32</b>	<b>35</b>	<b>38</b>	<b>41</b>	<b>43</b>	<b>46</b>	<b>49</b>	<b>52</b>	<b>54</b>	<b>67</b>	
bar		<b>1,8</b>	<b>2,0</b>	<b>2,2</b>	<b>2,4</b>	<b>2,6</b>	<b>2,8</b>	<b>3,0</b>	<b>3,2</b>	<b>3,4</b>	<b>3,6</b>	<b>3,7</b>	<b>4,6</b>	
<b>MAX. LOAD kg</b>														
25		660	705	745	780	820	855	890	925	960	990	1005		
<b>30</b>		575	610	645	680	710	745	775	805	835	860	<b>875</b>		
35		515	550	580	610	640	670	695	725	750	775	790		
40		460	490	515	545	570	595	620	645	665	690	700		
F													1310	
Loader													1745	

SIZE	Tread pattern	SW mm	OD mm	SLR mm	RC mm	Rims						Tube						
7.50-16 10 PR (109A6)	TD27	218	803	374	2436	5.50Fx16						6.50/7.00-16 TR15						
<b>PRESSURE</b>																		
psi		<b>26</b>	<b>29</b>	<b>32</b>	<b>35</b>	<b>38</b>	<b>41</b>	<b>43</b>	<b>46</b>	<b>49</b>	<b>52</b>	<b>55</b>	<b>58</b>	<b>61</b>	<b>64</b>	<b>67</b>	<b>68</b>	<b>84</b>
bar		<b>1,8</b>	<b>2,0</b>	<b>2,2</b>	<b>2,4</b>	<b>2,6</b>	<b>2,8</b>	<b>3,0</b>	<b>3,2</b>	<b>3,4</b>	<b>3,6</b>	<b>3,8</b>	<b>4,0</b>	<b>4,2</b>	<b>4,4</b>	<b>4,6</b>	<b>4,7</b>	<b>5,8</b>
<b>MAX. LOAD kg</b>																		
25		675	720	760	800	835	875	910	945	980	1015	1045	1080	1110	1140	1170	1185	
<b>30</b>		585	625	660	695	730	760	760	825	850	880	910	935	965	990	1015	<b>1030</b>	
35		530	565	595	625	655	685	715	740	765	795	820	845	870	890	915	925	
40		470	500	530	555	580	610	635	660	680	705	730	750	770	795	815	825	
F																		1535
Loader																		2045

SIZE	Tread pattern	SW mm	OD mm	SLR mm	RC mm	Rim	Permitted Rims	Tube	
4.00/4.50-21 4 PR	TD27	110	765	362	2270	3.00D	2.50C		
<b>PRESSURE</b>									
psi		<b>26</b>	<b>29</b>	<b>32</b>	<b>35</b>	<b>38</b>	<b>39</b>	<b>43</b>	
bar		<b>1,8</b>	<b>2,0</b>	<b>2,2</b>	<b>2,4</b>	<b>2,6</b>	<b>2,7</b>	<b>3,0</b>	
<b>MAX. LOAD kg</b>									
25		370	385	410	435	450	465		
<b>30</b>		345	365	385	410	425	<b>435</b>		
35		325	340	360	385	400	410		
40		310	325	345	365	380	390		
F									450

For technical notes about pressure tables please refer to page 260.

## TD27



# TD300

The TD300 is suitable for all types of terrain. Due to the strength of its carcass and the high resistance of its tread, which also provides a high level of straight line stability during ploughing, thus allowing high working speeds.



## SIZE

**9.5L-15 8 PR (102A8)**

**7.50-16 8 PR (103A6)**

**9.00-16 8 PR (111A6)**

## SIZE

**10.00-16 10 PR (119A8)**

**7.50-18 8 PR (106A6)**

**7.50-18 10 PR (113A6)**

SIZE	Tread pattern	SW mm	OD mm	SLR mm	RC mm	Rims	Tube
9.5L-15 8 PR (102A8)	TD300	248	780	733	2350	8LB	

### PRESSURE

psi	<b>26</b>	<b>29</b>	<b>32</b>	<b>35</b>	<b>38</b>	<b>41</b>	<b>44</b>	<b>48</b>	<b>60</b>	<b>64</b>
bar	<b>1,8</b>	<b>2,0</b>	<b>2,2</b>	<b>2,4</b>	<b>2,6</b>	<b>2,8</b>	<b>3,0</b>	<b>3,3</b>	<b>4,1</b>	<b>4,4</b>

### MAX. LOAD kg

20	825	885	930	980	1030	1070	1120	1180		
30	660	705	745	785	820	855	895	945		
<b>40</b>	595	635	670	705	740	770	805	<b>850</b>		
45	555	590	625	655	690	715	750	790		
F										1415
Loader										1695

## TD300

X-ply tire for tractors



SIZE	Tread pattern	SW mm	OD mm	SLR mm	RC mm	Rims						Tube
<b>7.50-16 8 PR</b> (103A6)	<b>TD300</b>	206	796	375	2446	5.50F						8.25-16 V3-02-08 TR76

#### PRESSURE

psi	<b>26</b>	<b>29</b>	<b>32</b>	<b>35</b>	<b>38</b>	<b>41</b>	<b>43</b>	<b>46</b>	<b>49</b>	<b>52</b>	<b>54</b>	<b>67</b>
bar	<b>1,8</b>	<b>2,0</b>	<b>2,2</b>	<b>2,4</b>	<b>2,6</b>	<b>2,8</b>	<b>3,0</b>	<b>3,2</b>	<b>3,4</b>	<b>3,6</b>	<b>3,7</b>	<b>4,6</b>

#### MAX. LOAD kg

25	660	705	745	780	820	855	890	925	960	990	1005	
<b>30</b>	575	610	645	680	710	745	775	805	835	860	<b>875</b>	
35	515	550	580	610	640	670	695	725	750	775	790	
40	460	490	515	545	570	595	620	645	665	690	700	
F												1310
Loader												1745

SIZE	Tread pattern	SW mm	OD mm	SLR mm	RC mm	Rims						Tube
<b>9.00-16 8 PR</b> (111A6)	<b>TD300</b>	254	850	400	2628	6.00Fx16						9.00-16 TR15

#### PRESSURE

psi	<b>26</b>	<b>29</b>	<b>32</b>	<b>35</b>	<b>38</b>	<b>41</b>	<b>43</b>	<b>45</b>	<b>55</b>
bar	<b>1,8</b>	<b>2,0</b>	<b>2,2</b>	<b>2,4</b>	<b>2,6</b>	<b>2,8</b>	<b>3,0</b>	<b>3,1</b>	<b>3,8</b>

#### MAX. LOAD kg

25	905	960	1015	1070	1120	1170	1220	1240	
<b>30</b>	785	835	885	930	975	1020	1060	<b>1090</b>	
35	705	750	795	835	875	915	955	970	
40	630	670	705	745	780	815	845	865	
F									1600
Loader									2135

According to availability

SIZE	Tread pattern	SW mm	OD mm	SLR mm	RC mm	Rims						Tube
<b>10.00-16 10 PR</b> (119A8)	<b>TD300</b>	280	886	833	2700	W8						

#### PRESSURE

psi	<b>26</b>	<b>29</b>	<b>32</b>	<b>35</b>	<b>38</b>	<b>41</b>	<b>44</b>	<b>46</b>	<b>49</b>	<b>61</b>	<b>65</b>
bar	<b>1,8</b>	<b>2,0</b>	<b>2,2</b>	<b>2,4</b>	<b>2,6</b>	<b>2,8</b>	<b>3,0</b>	<b>3,2</b>	<b>3,4</b>	<b>4,2</b>	<b>4,5</b>

#### MAX. LOAD kg

20	1300	1385	1465	1545	1610	1690	1760	1830	1890		
30	1040	1105	1170	1230	1290	1350	1405	1460	1510		
<b>40</b>	935	995	1055	1110	1160	1215	1265	1315	<b>1360</b>		
45	870	925	980	1030	1080	1130	1175	1225	1265		
F											2255
Loader											2700



SIZE	Tread pattern	SW mm	OD mm	SLR mm	RC mm	Rims	Tube
<b>7.50-18 8 PR</b> (106A6)	<b>TD300</b>	207	854	403	2625	5.50Fx18	7.50-18 TR15

#### PRESSURE

psi	<b>26</b>	<b>29</b>	<b>32</b>	<b>35</b>	<b>38</b>	<b>41</b>	<b>43</b>	<b>46</b>	<b>49</b>	<b>52</b>	<b>54</b>	<b>67</b>
bar	<b>1,8</b>	<b>2,0</b>	<b>2,2</b>	<b>2,4</b>	<b>2,6</b>	<b>2,8</b>	<b>3,0</b>	<b>3,2</b>	<b>3,4</b>	<b>3,6</b>	<b>3,7</b>	<b>4,6</b>

#### MAX. LOAD kg

25	715	760	805	850	890	930	965	1005	1040	1075	1095	
<b>30</b>	625	665	700	735	775	805	840	875	905	935	<b>950</b>	
35	560	595	630	665	695	725	755	785	815	840	855	
40	500	530	560	590	620	645	670	700	725	750	760	
F												1420
Loader												1895

SIZE	Tread pattern	SW mm	OD mm	SLR mm	RC mm	Rims	Tube
<b>7.50-18 10 PR</b> (113A6)	<b>TD300</b>	207	854	399	2594	5.50Fx18	7.50-18 TR15

#### PRESSURE

psi	<b>26</b>	<b>29</b>	<b>32</b>	<b>35</b>	<b>38</b>	<b>41</b>	<b>44</b>	<b>46</b>	<b>49</b>	<b>52</b>	<b>55</b>	<b>58</b>	<b>61</b>	<b>64</b>	<b>67</b>	<b>70</b>	<b>87</b>
bar	<b>1,8</b>	<b>2,0</b>	<b>2,2</b>	<b>2,4</b>	<b>2,6</b>	<b>2,8</b>	<b>3,0</b>	<b>3,2</b>	<b>3,4</b>	<b>3,6</b>	<b>3,8</b>	<b>4,0</b>	<b>4,2</b>	<b>4,4</b>	<b>4,6</b>	<b>4,8</b>	<b>6,0</b>

#### MAX. LOAD kg

25	745	790	840	880	925	965	1005	1045	1080	1120	1155	1190	1225	1255	1290	1325	
<b>30</b>	650	690	730	765	805	840	875	905	940	970	1005	1035	1065	1095	1120	<b>1150</b>	
35	585	620	655	690	725	755	785	815	845	875	905	930	960	985	1010	1035	
40	520	550	585	615	640	670	700	725	750	780	800	825	850	875	900	920	
F																	1725
Loader																	2300

According to availability

For technical notes about pressure tables please refer to page 260.

### TD300

X-ply tire for tractors



# T414

The Twin Tractor T414 line offers an increased output from tractors and other pulling machines.

T414 has a traction pattern with deep effective lugs in three different angles for maximum traction and excellent self cleaning.



SIZE	New tire		Tire in service		SLR mm	RC mm	SRI	Rim	Type	Speed Km/h	PRESSURE	
	SW mm	OD mm	SW mm	OD mm							psi	bar
<b>400/55-17.5</b> 125A8 (122B)	400	880	422	906	408	2640	415	AG11.75	TL		50	
											40	
											25	
											10HT/30	
											10 LT	
<b>T414</b>												

SIZE	New tire		Tire in service		SLR mm	RC mm	SRI	Rim	Type	Speed Km/h	PRESSURE	
	SW mm	OD mm	SW mm	OD mm							psi	bar
<b>600/55-26.5</b> 148A8 (145B)	600	1350	648	1379	620	4050	625	AG20.00	TL		50	
											40	
											25	
											10HT/30	
											10 LT	
<b>T414</b>												

According to availability

SIZE	New tire		Tire in service		SLR mm	RC mm	SRI	Rim	Type	Speed Km/h	PRESSURE	
	SW mm	OD mm	SW mm	OD mm							psi	bar
<b>600/55-30.5</b> 150A8 (147B)	600	1435	648	1475	670	4330	675	AG20.00	TL		50	
											40	
											25	
											10HT/30	
											10 LT	
<b>T414</b>												

SIZE	New tire		Tire in service		SLR mm	RC mm	SRI	Rim	Type	Speed Km/h	PRESSURE	
	SW mm	OD mm	SW mm	OD mm							psi	bar
<b>600/60-30.5</b> 153A8 (150B)	600	1510	638	1545	700	4485	700	AG20.00	TL		50	
											40	
											25	
											10HT/30	
											10 LT	
<b>T414</b>												

## SIZE

**400/55-17.5 125A8 (122B)**

**600/55-26.5 148A8 (145B)**

**600/55-30.5 150A8 (147B)**

**600/60-30.5 153A8 (150B)**

**800/55-30.5 172A8 (168B)**

## SIZE

**710/65-38 162A8 (158B)**

**850/50-38 163A8 (160B)**

**850/60-38 175A8 (172B)**

**850/55-42 161A8 (157B)**

7	12	14	17	20	22	23	26	29	32	35	38	41	43	45	46	49	52	55	58
0,5	0,8	1,0	1,2	1,4	1,5	1,6	1,8	2,0	2,2	2,4	2,6	2,8	3,0	3,1	3,2	3,4	3,6	3,8	4,0
575	730	830	925	1025	1070	1120	1215	1310	1405	1500									
630	800	915	1030	1140	1195	1250	1355	1455	1555	<b>1650</b>									
695	890	1015	1145	1265	1325	1390	1500	1615	1725	1830									
670	855	980	1100	1220	1280	1340	1450	1555	1660	1765									
855	1060	1200	1340	1475	1545	1610	1745	1875	1995	2125	2240	2365	2475						
955	1180	1330	1480	1630	1705	1780	1925	2070	2205	2335	2470	2595	2730						

7	12	14	17	20	22	23	26	29	32	35	38	41	43	45	46	49	52	55	58
0,5	0,8	1,0	1,2	1,4	1,5	1,6	1,8	2,0	2,2	2,4	2,6	2,8	3,0	3,1	3,2	3,4	3,6	3,8	4,0
1255	1600	1780	1950	2190	2310	2430	2570	2695	2805	2900									
1375	1750	1970	2180	2415	2535	2650	2800	2930	3050	<b>3150</b>									
1525	1945	2185	2420	2680	2810	2940	3105	3255	3385	3495									
1470	1875	2105	2335	2585	2710	2835	2995	3135	3260	3370									
1875	2325	2625	2880	3150	3270	3410	3695	3975	4125	4335	4455	4640	4725						
2095	2580	2910	3210	3480	3610	3770	4075	4385	4620	4770	4985	5095	5285						

7	12	14	17	20	22	23	26	29	32	35	38	41	43	45	46	49	52	55	58
0,5	0,8	1,0	1,2	1,4	1,5	1,6	1,8	2,0	2,2	2,4	2,6	2,8	3,0	3,1	3,2	3,4	3,6	3,8	4,0
1335	1700	1915	2120	2350	2460	2575	2720	2855	2970	3075									
1455	1850	2080	2300	2550	2675	2800	2960	3105	3235	<b>3350</b>									
1615	2055	2310	2555	2830	2970	3110	3285	3450	3590	3720									
1555	1980	2225	2460	2730	2860	2995	3170	3325	3465	3585									
1985	2460	2775	3040	3325	3450	3600	3900	4200	4365	4590	4725	4925	5025						
2210	2730	3075	3395	3675	3810	3975	4305	4630	4885	5050	5280	5410	5615						

7	12	14	17	20	22	23	26	29	32	35	38	41	43	45	46	49	52	55	58
0,5	0,8	1,0	1,2	1,4	1,5	1,6	1,8	2,0	2,2	2,4	2,6	2,8	3,0	3,1	3,2	3,4	3,6	3,8	4,0
1415	1800	2050	2300	2550	2675	2800	2960	3105	3235	3350									
1570	2000	2255	2500	2785	2930	3075	3245	3400	3535	<b>3650</b>									
1745	2220	2500	2775	3090	3250	3415	3605	3775	3925	4050									
1680	2140	2410	2675	2980	3135	3290	3475	3635	3780	3905									
2145	2660	3000	3295	3610	3750	3925	4265	4615	4785	5025	5165	5375	5475						
2390	2955	3325	3675	3990	4140	4325	4700	5075	5360	5530	5780	5910	6125						

## Twin Tractor: T414

X-ply tire for tractors



SIZE	New tire		Tire in service				SRI	Rim	Type	Speed Km/h	PRESSURE	
	SW mm	OD mm	SW mm	OD mm	SLR mm	RC mm					psi	bar
<b>800/55-30.5</b> 172A8 (168B)	820	1650	862	1716	760	4900	770	AG28.00	TL	50		
										<b>40</b>		
										25		
										10HT/30		
										10 LT		
<b>T414</b>									10 C			

SIZE	New tire		Tire in service				SRI	Rim	Type	Speed Km/h	PRESSURE	
	SW mm	OD mm	SW mm	OD mm	SLR mm	RC mm					psi	bar
<b>710/65-38</b> 162A8 (158B)	710	1860	774	1953	870	5626	900	DW24B	TL	50		
										<b>40</b>		
										25		
										10HT/30		
										10 LT		
<b>T414</b>									10 C			

SIZE	New tire		Tire in service				SRI	Rim	Type	Speed Km/h	PRESSURE	
	SW mm	OD mm	SW mm	OD mm	SLR mm	RC mm					psi	bar
<b>850/50-38</b> 163A8 (160B)	850	1860	921	1875	850	5580	855	DW28B	TL	50		
										<b>40</b>		
										25		
										10HT/30		
										10 LT		
<b>T414</b>									10 C			

SIZE	New tire		Tire in service				SRI	Rim	Type	Speed Km/h	PRESSURE	
	SW mm	OD mm	SW mm	OD mm	SLR mm	RC mm					psi	bar
<b>850/60-38</b> 175A8 (172B)	850	1980	921	2057	910	5880	950	DW28B	TL	50		
										<b>40</b>		
										25		
										10HT/30		
										10 LT		
<b>T414</b>									10 C			

SIZE	New tire		Tire in service				SRI	Rim	Type	Speed Km/h	PRESSURE	
	SW mm	OD mm	SW mm	OD mm	SLR mm	RC mm					psi	bar
<b>850/55-42</b> 161A8 (157B)	850	1990	921	2067	900	5880	950	DW28B	TL	50		
										<b>40</b>		
										25		
										10HT/30		
										10 LT		
<b>T414</b>												

7	12	14	17	20	22	23	26	29	32	35	38	41	43	45	46	49	52	55	58
0,5	0,8	1,0	1,2	1,4	1,5	1,6	1,8	2,0	2,2	2,4	2,6	2,8	3,0	3,1	3,2	3,4	3,6	3,8	4,0
2085	2650	2960	3250	3625	3810	4000	4250	4475	4685	4875	5080	5270	5440	5525	5600				
2280	2900	3280	3650	4015	4195	4375	4640	4880	5100	5300	5565	5820	6065	6185	<b>6300</b>				
2530	3220	3640	4050	4460	4660	4855	5150	5420	5665	5885	6180	6460	6735	6865	6995				
2440	3105	3510	3905	4295	4490	4680	4965	5225	5460	5670	5955	6230	6490	6620	6740				
3110	3855	4350	4795	5260	5475	5690	6145	6565	6845	7205	7435	7765	7950	8100	8245	8595	8870	9200	9450
3470	4280	4825	5335	5810	6045	6310	6775	7265	7640	7925	8300	8530	8870	8965	9125	9510	9805	10175	10450

7	12	14	17	20	22	23	26	29	32	35	38	41	43	45	46	49	52	55	58
0,5	0,8	1,0	1,2	1,4	1,5	1,6	1,8	2,0	2,2	2,4	2,6	2,8	3,0	3,1	3,2	3,4	3,6	3,8	4,0
2280	2900	3235	3550	3905	4080	4250													
2475	3150	3580	4000	4380	4565	<b>4750</b>													
2745	3495	3970	4440	4865	5070	5275													
2650	3370	3830	4280	4690	4885	5085													
3375	4185	4725	5230	5750	6000	6220	6705	7125											
3765	4650	5240	5810	6355	6625	6915	7390	7905											

7	12	14	17	20	22	23	26	29	32	35	38	41	43	45	46	49	52	55	58
0,5	0,8	1,0	1,2	1,4	1,5	1,6	1,8	2,0	2,2	2,4	2,6	2,8	3,0	3,1	3,2	3,4	3,6	3,8	4,0
2280	2900	3280	3650	4075	4285	4500													
2555	3250	3635	4000	4440	4655	<b>4875</b>													
2835	3610	4035	4440	4925	5170	5410													
2730	3480	3890	4280	4750	4980	5215													
3480	4315	4875	5315	5800	6000	6265	6790	7315											
3885	4795	5405	5945	6405	6625	6915	7485	8060											

7	12	14	17	20	22	23	26	29	32	35	38	41	43	45	46	49	52	55	58
0,5	0,8	1,0	1,2	1,4	1,5	1,6	1,8	2,0	2,2	2,4	2,6	2,8	3,0	3,1	3,2	3,4	3,6	3,8	4,0
2710	3450	3860	4250	4770	5035	5300	5595	5860	6095	6300									
2945	3750	4255	4750	5275	5535	5800	6125	6415	6675	<b>6900</b>									
3270	4165	4720	5275	5855	6145	6440	6800	7125	7410	7660									
3155	4015	4550	5085	5645	5925	6205	6555	6865	7140	7385									
4020	4985	5625	6220	6835	7125	7440	8070	8700	9035	9490	9755	10155	10350						
4485	5535	6235	6910	7550	7870	8215	8900	9585	10110	10440	10910	11160	11575						

7	12	14	17	20	22	23	26	29	32	35	38	41	43	45	46	49	52	55	58
0,5	0,8	1,0	1,2	1,4	1,5	1,6	1,8	2,0	2,2	2,4	2,6	2,8	3,0	3,1	3,2	3,4	3,6	3,8	4,0
2630	3350	3745	4125																
2870	3650	4140	<b>4625</b>																
3185	4050	4595	5135																
3070	3905	4430	4950																
3910	4850	5475	6055	6655	6940														

For technical notes about pressure tables please refer to page 260.

## Twin Tractor: T414

X-ply tire for tractors



# IM110



# IM220



Suitable for use on medium-low powered farm machineries. The lug shape and groove base of the IM110 together with the inter-lug terraces and veining, result in excellent traction.

The differentiated rigidity of the whole tire section also enables it to keep itself clean, thus further improving traction.

SIZE	LI/SS	New tire		Tire in service		SLR mm +/-2%	RC mm +/-2.5%	Rim	Permitted rims	Tube	Speed Km/h	PRESSURE	
		SW mm +/-1.5%	OD mm +/-1.5%	SW max mm	OD max mm							psi bar	MAX. LOAD kg
5.0-10 4PR IM110	74A8 ↻	135	515	152	525	236	1566	4J	3.50B	4.00/4.10 /4.40 /5.00-10 TR13	Free Rolling		
											50		
	62A8 ↻										Driving wheel		
												50	
												40	
												25	
												10	
												10 C	

SIZE	LI/SS	New tire		Tire in service		SLR mm +/-2%	RC mm +/-2.5%	Rim	Permitted rims	Tube	Speed Km/h	PRESSURE	
		SW mm +/-1.5%	OD mm +/-1.5%	SW max mm	OD max mm							psi bar	MAX. LOAD kg
4.00-12 2PR IM110	54A8 ↻	115	535	120	537	247	1605	3.00B	3.00D-3.50B 2.50CSC	4.00-12 TR13	Free Rolling		
											50		
	42A8 ↻										Driving wheel		
												50	
												40	
												25	
												10	
												10 C	

SIZE		IM110
5.0-10	4 PR	(74A8)
4.00-12	2 PR	(54A8)
5.00-12	4 PR	(74A8)
6.5/80-12	4 PR	(84A8)
7.00-12	6 PR	(95A8)
10.0/80-12	6 PR	(110A8)
5.00-14	4 PR	(73A8)
5.00-15	6 PR	(88A8)
6.5/80-15	4 PR	(90A8)
7.5L-15	8 PR	(113A8)
10.0/75-15.3	8 PR	(119A8)
10.0/75-15.3	10 PR	(123A8)
6.00-16	8 PR	(103A8)
6.50-16	8 PR	(105A8)

SIZE		IM110
7.50-16	8 PR	(112A8)
7.50-16 TL	8 PR	(112A8)
8.25-16	8 PR	(116A8)
9.0/75-16	6 PR	(111A8)
250/80-16	8 PR	(125A8)
7.50-18	6 PR	(106A8)
250/80-18	8 PR	(127A8)
4.50-19	2 PR	(66A8)
4.00-21	2 PR	(66A8)

SIZE	IM220
210/95-20 TL	119A8

7	12	14	17	20	22	26	29	30	32	33	35	36	38	41	42
0,5	0,8	1,0	1,2	1,4	1,5	1,8	2,0	2,1	2,2	2,3	2,4	2,5	2,6	2,8	2,9
150	195	225	250	275	285	320	340								
165	220	250	280	305	315	355	375								
235	305	350	390	425	445	495	525								
105	140	160	175	195	200	225	240								
120	155	175	195	215	225	250	265								
140	185	210	235	255	265	295	315								
165	215	250	275	300	315	350	370								
190	245	275	310	340	355	395	420	435	440	455	465	475	490		

7	12	14	17	20	22	26	29	30	32	33	35	36	38	41	42
0,5	0,8	1,0	1,2	1,4	1,5	1,8	2,0	2,1	2,2	2,3	2,4	2,5	2,6	2,8	2,9
100	130	150	165	185	190										
110	145	165	185	205	212										
155	205	235	260	285	295										
70	95	105	120	130	135										
80	105	120	130	145	150										
95	125	140	155	170	180										
110	145	165	185	200	210										
125	165	190	205	230	235	260	275								

## IM110 - IM220

X-ply tire for tractors, crop processing and green area equipment



SIZE	LI/SS	New tire		Tire in service				Rim	Permitted rims	Tube	Speed Km/h	PRESSURE	
		SW mm +/-1.5%	OD mm +/-1.5%	SW max mm	OD max mm	SLR mm +/-2%	RC mm +/-2.5%					psi bar MAX. LOAD kg	
5.00-12 4PR IM110	74A8 ↔	135	584	152	592	253	1705	3.00D	3.50D 4J 4.00E	6-12 TR13	Free Rolling		
	62A8 ↺												
											40		
											10		
											Driving wheel		
											50		
											40		
											25		
											10		
											10 C		

SIZE	LI/SS	New tire		Tire in service				Rim	Permitted rims	Tube	Speed Km/h	PRESSURE	
		SW mm +/-1.5%	OD mm +/-1.5%	SW max mm	OD max mm	SLR mm +/-2%	RC mm +/-2.5%					psi bar MAX. LOAD kg	
6.5/80-12 4PR IM110	84A8 ↔	160	600	170	609	270	1786	5JA	5J	6-12 TR13	Free Rolling		
	72A8 ↺												
											40		
											10		
											Driving wheel		
											50		
											40		
											25		
											10		
											10 C		

SIZE	LI/SS	New tire		Tire in service				Rim	Permitted rims	Tube	Speed Km/h	PRESSURE	
		SW mm +/-1.5%	OD mm +/-1.5%	SW max mm	OD max mm	SLR mm +/-2%	RC mm +/-2.5%					psi bar MAX. LOAD kg	
7.00-12 6PR IM110	95A8 ↔	192	680	196	690	308	2029	5JA	4.50E-5.00F 5.00B-5.50F	7.00-12 TR15	Free Rolling		
	83A8 ↺												
											40		
											10		
											Driving wheel		
											50		
											40		
											25		
											10		
											10 C		

SIZE	LI/SS	New tire		SLR mm +/-1.5%	RC mm +/-2.5%	Rim	Permitted rims	Tube	Speed Km/h	PRESSURE		
		SW mm +/-1.5%	OD mm +/-1.5%							psi bar MAX. LOAD kg		
10.0/80-12 6PR IM110	110A8 ↔	250	753	321	2187	7.00	9.00	8.50-12/ /10.0 /80-12 TR15	Free Rolling			
	98A8 ↺											
											40	
											10	
											Driving wheel	
											50	
											40	
											25	
											10	
											10 C	



7	12	14	17	20	22	26	29	30	32	33	35	36	38	39	41	42	43	46	51
0,5	0,8	1,0	1,2	1,4	1,5	1,8	2,0	2,1	2,2	2,3	2,4	2,5	2,6	2,7	2,8	2,9	3,0	3,2	3,5
125	165	190	210	230	240	265	285	290	300	305	315	320	330	340					
140	185	210	235	255	265	295	315	325	335	340	350	360	365	<b>375</b>					
195	260	295	325	355	370	415	440	455	465	475	490	500	515	525					
90	115	135	150	160	170	190	200	205	210	215	220	230	235	240					
100	130	150	165	180	190	210	220	230	235	240	245	255	260	<b>265</b>					
120	155	175	195	215	225	250	265	275	280	285	295	300	310	315					
140	180	205	230	250	265	295	310	320	330	335	345	355	365	370					
160	205	235	260	285	300	330	345	365	370	380	385	400	410	420	425	435	440	465	490

7	12	14	17	20	22	26	29	30	32	33	35	36	38	39	41	42	43	45	46	51	54	58	62	67	70	71	75	
0,5	0,8	1,0	1,2	1,4	1,5	1,8	2,0	2,1	2,2	2,3	2,4	2,5	2,6	2,7	2,8	2,9	3,0	3,1	3,2	3,5	3,7	4,0	4,3	4,6	4,8	5,0	5,2	
180	235	270	300	330	340	380	405	415	430	440	450																	
200	265	300	335	365	380	425	450	460	475	490	<b>500</b>																	
280	370	420	465	510	530	590	630	645	665	685	700																	
130	170	190	215	235	245	270	285	295	305	310	320																	
140	185	215	235	260	270	300	320	330	335	345	<b>355</b>																	
170	225	255	280	310	320	355	380	390	400	410	420																	
200	260	300	330	365	380	420	445	460	470	485	495																	
220	290	340	370	410	425	475	505	520	530	545	560	575	585	600	615	625	640	645										

7	12	14	17	20	22	26	29	30	32	33	35	36	38	39	41	42	43	46	48	51	54	58	62	67	70	71	75	
0,5	0,8	1,0	1,2	1,4	1,5	1,8	2,0	2,1	2,2	2,3	2,4	2,5	2,6	2,7	2,8	2,9	3,0	3,2	3,3	3,5	3,7	4,0	4,3	4,6	4,8	5,0	5,2	
240	320	365	405	445	460	510	545	560	575	590	605	620																
270	355	405	450	490	510	570	605	625	640	655	675	<b>690</b>																
375	495	565	630	690	715	795	850	870	895	920	945	965																
170	225	255	285	310	325	360	385	395	405	420	430	440																
190	250	285	315	345	360	400	425	440	450	465	475	<b>485</b>																
225	300	340	375	415	430	480	510	525	540	550	565	580																
265	350	400	445	485	505	565	600	615	635	650	665	680																
300	395	450	495	545	570	630	670	695	710	735	750	765	790	805	820	835	850	890	905									

7	12	14	17	20	22	26	29	30	32	33	35	36	38	39	41	42	43	45	46	51	54	58	62	67	70	72	75	
0,5	0,8	1,0	1,2	1,4	1,5	1,8	2,0	2,1	2,2	2,3	2,4	2,5	2,6	2,7	2,8	2,9	3,0	3,1	3,2	3,5	3,7	4,0	4,3	4,6	4,8	5,0	5,2	
390	515	585	650	715	745	825	880	905	930	955																		
435	570	650	725	795	825	920	975	1005	1035	<b>1060</b>																		
610	800	910	1015	1110	1155	1285	1370	1405	1445	1485																		
275	365	415	460	505	525	585	620	640	660	675																		
305	405	460	515	560	585	650	690	710	730	<b>750</b>																		
365	480	550	610	670	695	775	820	845	870	895																		
430	565	645	720	785	820	910	965	995	1025	1050																		
480	640	725	810	885	925	1025	1090	1120	1150	1185	1215	1240	1270	1300	1325	1355	1380											



SIZE	LI/SS	New tire		Tire in service				Rim	Permitted rims	Tube	Speed Km/h	PRESSURE	
		SW mm +/-1.5%	OD mm +/-1.5%	SW max mm	OD max mm	SLR mm +/-2%	RC mm +/-2.5%					psi bar MAX. LOAD kg	
5.00-14 4PR IM110	73A8 ↻	130	636	152	644	292	1913	3.00D	3.50D-4.00E-4J	ER14 135 /145R14 TR13	Free Rolling 50 40 10		
	61A8 ↻										Driving wheel 50 40 25 10 10 C		

SIZE	LI/SS	New tire		Tire in service				Rim	Permitted rims	Tube	Speed Km/h	PRESSURE	
		SW mm +/-1.5%	OD mm +/-1.5%	SW max mm	OD max mm	SLR mm +/-2%	RC mm +/-2.5%					psi bar MAX. LOAD kg	
5.00-15 6PR IM110	88A8 ↻	129	661	140	670	300	1985	3.00D	3.50D-4.00E 4J-4.5J	5.00-15 TR13	Free Rolling 50 40 10		
	75A8 ↻										Driving wheel 50 40 25 10 10 C		

SIZE	LI/SS	New tire		Tire in service				Rim	Permitted rims	Tube	Speed Km/h	PRESSURE	
		SW mm +/-1.5%	OD mm +/-1.5%	SW max mm	OD max mm	SLR mm +/-2%	RC mm +/-2.5%					psi bar MAX. LOAD kg	
6.5/80-15 4PR IM110	90A8 ↻	165	685	171	695	313	2051	5J	4.5K-5K-5.5J	165-15 TR13	Free Rolling 50 40 10		
	78A8 ↻										Driving wheel 50 40 25 10 10 C		

SIZE	LI/SS	New tire		Tire in service				Rim	Permitted rims	Tube	Speed Km/h	PRESSURE	
		SW mm +/-1.5%	OD mm +/-1.5%	SW max mm	OD max mm	SLR mm +/-2%	RC mm +/-2.5%					psi bar MAX. LOAD kg	
7.5L-15 8PR IM110	113A8 ↻	200	755	220	783	321	2196	6LB	5K-5.5J-5.5K	KR 15 195/ 205R15 TR13	Free Rolling 50 40 10		
	100A8 ↻										Driving wheel 50 40 25 10 10 C		

7 0,5	12 0,8	14 1,0	17 1,2	20 1,4	22 1,5	26 1,8	29 2,0	30 2,1	32 2,2	33 2,3	35 2,4	36 2,5	38 2,6	39 2,7	41 2,8	42 2,9	43 3,0	46 3,2	51 3,5
140	180	205	230	250	265	295	310	320	330										
155	200	230	255	280	290	325	345	355	<b>365</b>										
215	285	320	360	390	410	455	485	495	510										
95	130	145	160	175	185	205	220	225	230										
110	140	160	180	195	205	230	245	250	<b>255</b>										
130	170	195	215	235	245	275	290	300	305										
150	200	225	250	275	285	320	340	350	360										
175	220	250	285	310	325	365	385	395	400	420	425	435	450	455	465	475			

7 0,5	12 0,8	14 1,0	17 1,2	20 1,4	22 1,5	26 1,8	29 2,0	32 2,2	35 2,4	38 2,6	41 2,8	43 3,0	46 3,2	51 3,5	54 3,7	59 4,1	62 4,3	67 4,6
160	210	240	270	295	305	340	365	385	405	425	440	460	480	505				
180	235	270	300	330	340	380	405	425	450	470	490	510	530	<b>560</b>				
250	330	375	420	460	475	530	565	600	630	660	685	715	745	785				
110	145	165	185	205	210	235	250	265	280	295	305	320	330	350				
125	165	185	205	225	235	260	280	295	310	325	340	355	365	<b>385</b>				
150	195	220	245	270	280	310	330	350	370	385	405	420	435	460				
175	230	260	290	315	330	365	390	415	435	455	475	495	515	540				
195	260	290	325	355	370	410	440	465	490	515	535	560	575	605	630	670	685	720

7 0,5	12 0,8	14 1,0	17 1,2	20 1,4	22 1,5	26 1,8	29 2,0	30 2,1	32 2,2	33 2,3	35 2,4	36 2,5	38 2,6	39 2,7	41 2,8	42 2,9	43 3,0	45 3,1	46 3,2	51 3,5	54 3,7	58 4,0	62 4,3	67 4,6	70 4,8	72 5,0	75 5,2	
215	285	325	360	395	410	455	485	500	515	525	540																	
240	315	360	400	440	455	505	539	555	570	585	<b>600</b>																	
335	440	505	560	615	640	710	755	775	800	820	840																	
155	200	230	255	280	290	325	345	355	365	375	385																	
170	225	255	285	310	325	360	380	395	405	415	<b>425</b>																	
200	265	305	335	370	385	425	455	470	480	495	505																	
240	310	355	395	435	450	505	535	550	565	580	595																	
270	355	400	450	490	515	570	600	625	640	655	670	685	700	720	735	750	765	780										

12 0,8	14 1,0	17 1,2	20 1,4	22 1,5	26 1,8	29 2,0	32 2,2	35 2,4	38 2,6	41 2,8	43 3,0	46 3,2	51 3,5	54 3,7	58 4,0	62 4,3	67 4,6	70 4,8	72 5,0	75 5,2
420	480	535	585	610	680	720	765	805	840	880	915	950	1000	1035						
470	535	595	650	680	755	800	850	895	935	975	1015	1055	1115	<b>1150</b>						
655	750	835	910	950	1055	1125	1185	1250	1310	1370	1425	1480	1560	1610						
295	335	375	410	425	475	500	530	560	585	610	635	660	695	720						
325	370	415	455	470	525	560	590	620	650	680	710	735	775	<b>800</b>						
390	445	495	540	560	625	665	700	740	775	810	845	875	920	950						
460	520	580	635	660	735	780	825	870	910	950	990	1030	1085	1120						
515	585	655	720	740	830	885	930	980	1025	1070	1120	1160	1220	1260	1315	1380	1435	1465		

## IM110 - IM220

X-ply tire for tractors, crop processing and green area equipment



SIZE	LI/SS	New tire		Tire in service				Rim	Permitted rims	Tube	Speed Km/h	PRESSURE	
		SW mm +/-1.5%	OD mm +/-1.5%	SW max mm	OD max mm	SLR mm +/-2%	RC mm +/-2.5%					psi bar	MAX. LOAD kg
10.0/75-15.3 8PR IM110	119A8 ↻	260	800	277	810	358	2388	9.00	9.00FB	10.0/ 75-15.3 TR15	Free Rolling		
													50
											40		
											10		
	106A8 ↻										Driving wheel		
											50		
											40		
											25		
											10		
											10 C		

SIZE	LI/SS	New tire		Tire in service				Rim	Permitted rims	Tube	Speed Km/h	PRESSURE	
		SW mm +/-1.5%	OD mm +/-1.5%	SW max mm	OD max mm	SLR mm +/-2%	RC mm +/-2.5%					psi bar	MAX. LOAD kg
10.0/75-15.3 10PR IM110	123A8 ↻	265	805	282	815	370	2433	9.00	9.00FB		Free Rolling		
													50
											40		
											10		
	111A8 ↻										Driving wheel		
											50		
											40		
											25		
											10		
											10 C		

SIZE	LI/SS	New tire		Tire in service				Rim	Permitted rims	Tube	Speed Km/h	PRESSURE	
		SW mm +/-1.5%	OD mm +/-1.5%	SW max mm	OD max mm	SLR mm +/-2%	RC mm +/-2.5%					psi bar	MAX. LOAD kg
6.00-16 8PR IM110	103A8 ↻	175	750	177	760	342	2253	4.50E	4.25KA - 4.5K 4.00E	6.00-16 TR15	Free Rolling		
													50
											40		
											10		
	91A8 ↻										Driving wheel		
											50		
											40		
											25		
											10		
											10 C		

SIZE	LI/SS	New tire		Tire in service				Rim	Permitted rims	Tube	Speed Km/h	PRESSURE	
		SW mm +/-1.5%	OD mm +/-1.5%	SW max mm	OD max mm	SLR mm +/-2%	RC mm +/-2.5%					psi bar	MAX. LOAD kg
6.50-16 8PR IM110	105A8 ↻	183	762	198	769	351	2304	5.50F	4.5K-6.50E-5K 5.00F-(4.00E)	8.25-16 V3-02-08 TR76	Free Rolling		
													50
											40		
											10		
	93A8 ↻										Driving wheel		
											50		
											40		
											25		
											10		
											10 C		

7	12	14	17	20	22	26	29	32	35	38	41	43	45	46	51	54	58	62	67	70	72	75
0,5	0,8	1,0	1,2	1,4	1,5	1,8	2,0	2,2	2,4	2,6	2,8	3,0	3,1	3,2	3,5	3,7	4,0	4,3	4,6	4,8	5,0	5,2
420	555	630	705	770	800	890	945	1000	1055	1105	1155	1200	1225									
470	615	700	780	855	890	990	1050	1115	1170	1225	1280	1335	<b>1360</b>									
655	860	985	1095	1195	1245	1385	1475	1560	1640	1720	1795	1870	1905									
295	385	440	490	535	560	620	660	700	735	770	805	840	855									
325	430	490	545	595	620	690	735	775	820	855	895	930	<b>950</b>									
390	510	585	650	710	740	820	875	925	975	1020	1065	1110	1130									
460	600	685	765	835	870	965	1030	1090	1145	1200	1255	1305	1330									
515	680	775	860	940	980	1090	1160	1220	1295	1350	1410	1465	1500	1530	1610	1665	1745					

7	12	14	17	20	26	29	32	35	38	41	43	45	46	51	54	57	62	67	70	72	74	
0,5	0,8	1,0	1,2	1,5	1,8	2,0	2,2	2,4	2,6	2,8	3,0	3,1	3,2	3,5	3,7	3,9	4,3	4,6	4,8	5,0	5,1	
420	555	630	700	795	885	945	1000	1050	1105	1150	1195	1220	1240	1310	1355	1395						
465	615	700	780	885	985	1050	1110	1165	1225	1275	1330	1355	1380	1455	1505	<b>1550</b>						
650	860	980	1090	1240	1380	1470	1555	1630	1715	1785	1860	1895	1930	2035	2105	2170						
295	385	440	490	565	625	660	700	740	775	810	840	860	875	925	950	980						
330	430	490	545	625	695	735	780	820	860	900	935	955	970	1025	1055	<b>1090</b>						
395	510	585	650	745	825	875	930	975	1025	1070	1115	1135	1155	1220	1255	1295						
460	600	685	765	875	975	1030	1090	1150	1205	1260	1310	1335	1360	1435	1475	1525						
520	680	775	860	985	1095	1160	1230	1295	1355	1420	1475	1505	1530	1615	1665	1720	1820	1890	1940	1985	2010	

14	17	22	26	29	32	35	38	39	42	46	51	54	58	62	67	70	72	75			
1,0	1,2	1,5	1,8	2,0	2,2	2,4	2,6	2,9	3,0	3,2	3,5	3,7	4,0	4,3	4,6	4,8	5,0	5,2			
350	390	445	495	525	555	585	610	640	665	690	730	750	790								
390	435	495	550	585	615	650	680	710	740	770	810	835	<b>875</b>								
545	605	690	765	815	865	910	950	995	1035	1075	1135	1170	1225								
245	275	310	345	370	390	410	430	450	470	485	510	530	555								
275	305	345	385	410	435	455	480	500	520	540	570	590	<b>615</b>								
325	360	410	460	490	515	545	570	595	620	645	675	700	730								
380	425	485	540	575	605	640	670	700	730	755	795	825	860								
435	480	545	605	645	685	720	755	790	820	850	900	930	970	1010	1050	1080	1105	1130			

12	14	17	20	22	26	29	32	35	38	41	43	46	51	54	58	62	67	70	72	75	
0,8	1,0	1,2	1,4	1,5	1,8	2,0	2,2	2,4	2,6	2,8	3,0	3,2	3,5	3,7	4,0	4,3	4,6	4,8	5,0	5,2	
340	385	430	470	490	545	580	615	645	675	705	735	765	805	835							
380	430	480	525	545	605	645	680	720	750	785	820	850	895	<b>925</b>							
530	600	670	735	765	850	905	955	1005	1055	1100	1145	1190	1255	1295							
240	270	300	330	345	385	410	430	455	475	495	520	535	565	585							
265	300	335	370	385	425	455	480	505	530	550	575	595	630	<b>650</b>							
315	360	400	440	455	505	540	570	600	630	655	685	710	750	775							
370	425	470	515	535	595	635	670	705	740	775	805	835	880	910							
420	475	530	585	605	670	720	755	795	835	865	905	940	995	1025	1070	1120	1165	1190			

## IM110 - IM220

X-ply tire for tractors, crop processing and green area equipment



SIZE	LI/SS	New tire		Tire in service				Rim	Permitted rims	Tube	Speed Km/h	PRESSURE	
		SW mm +/-1.5%	OD mm +/-1.5%	SW max mm	OD max mm	SLR mm +/-2%	RC mm +/-2.5%					psi bar	MAX. LOAD kg
7.50-16 8PR IM110	112A8 ↻→	208	805	225	819	363	2413	5.50F	5.00F-5K 6.00F-6LB (5.50FSDC-4.50E)	8.25-16 V3-02-08 TR76	Free Rolling		
	99A8 ↻												50
											40		
											10		
											Driving wheel		
											50		
											40		
											25		
											10		
											10 C		

SIZE	LI/SS	New tire		Tire in service				Rim	Permitted rims	Tube	Speed Km/h	PRESSURE	
		SW mm +/-1.5%	OD mm +/-1.5%	SW max mm	OD max mm	SLR mm +/-2%	RC mm +/-2.5%					psi bar	MAX. LOAD kg
8.25-16 8PR IM110	116A8 ↻→	215	825	240	849	373	2469	5.50F			Free Rolling		
	104A8 ↻												
											40		
											10		
											Driving wheel		
											50		
											40		
											25		
											10		
											10 C		

SIZE	LI/SS	New tire		Tire in service				Rim	Permitted rims	Tube	Speed Km/h	PRESSURE	
		SW mm +/-1.5%	OD mm +/-1.5%	SW max mm	OD max mm	SLR mm +/-2%	RC mm +/-2.5%					psi bar	MAX. LOAD kg
9.0/75-16 6PR IM110	111A8 ↻→	225	780	238	786	349	2330	W8	W7	9.00-16 TR15	Free Rolling		
	99A8 ↻												
											40		
											10		
											Driving wheel		
											50		
											40		
											25		
											10		
											10 C		

SIZE	LI/SS	New tire		Tire in service				Rim	Permitted rims	Tube	Speed Km/h	PRESSURE	
		SW mm +/-1.5%	OD mm +/-1.5%	SW max mm	OD max mm	SLR mm +/-2%	RC mm +/-2.5%					psi bar	MAX. LOAD kg
250/80-16 8PR IM110	125A8 ↻→	240	816	271	834	364	2424	W8	W7-W9	9.00-16 TR15	Free Rolling		
	113A8 ↻												
											40		
											10		
											Driving wheel		
											50		
											40		
											25		
											10		
											10 C		

7	12	14	17	20	22	26	29	32	35	38	41	43	46	50	53	57	60
0,5	0,8	1,0	1,2	1,4	1,5	1,8	2,0	2,2	2,4	2,6	2,8	3,0	3,2	3,5	3,7	4,0	4,2
340	450	510	570	620	645	720	765	810	850	895	930	970	1010				
380	500	565	630	691	720	800	850	900	945	990	1035	1080	<b>1120</b>				
530	695	795	885	965	1005	1120	1190	1260	1325	1390	1450	1510	1570				
235	310	355	395	430	450	500	530	560	590	615	645	670	700				
260	345	390	435	480	500	554	590	620	655	685	715	745	<b>775</b>				
310	410	465	520	570	595	660	700	740	780	815	855	890	920				
365	480	550	610	670	695	775	825	870	915	960	1005	1045	1085				
410	545	615	685	755	790	875	930	980	1035	1080	1130	1175	1220	1285	1335	1395	1435

7	12	14	17	20	22	26	29	32	35	38	41	42	43	46	51	54	55	58	61	62	67	70	72	75
0,5	0,8	1,0	1,2	1,4	1,5	1,8	2,0	2,2	2,4	2,6	2,8	2,9	3,0	3,2	3,5	3,7	3,8	4,0	4,2	4,3	4,6	4,8	5,0	5,2
400	530	605	670	735	765	850	905	955	1005	1055	1105	1125												
445	590	670	745	815	850	945	1005	1065	1120	1175	1200	<b>1250</b>												
625	825	940	1045	1140	1190	1325	1410	1490	1565	1640	1715	1750												
290	380	435	485	530	550	615	650	690	725	760	795	810												
320	425	485	535	590	610	680	725	765	805	845	880	<b>900</b>												
385	505	575	640	700	730	810	860	910	960	1005	1050	1070												
450	595	675	750	825	855	955	1015	1070	1130	1180	1235	1260												
505	670	765	845	930	960	1070	1145	1205	1270	1335	1390	1420	1450	1505	1585	1640	1665							

7	12	14	17	20	22	26	29	30	32	33	35	36	38	41	43	46	49	51	54	58	62	67	70	72
0,5	0,8	1,0	1,2	1,4	1,5	1,8	2,0	2,1	2,2	2,3	2,4	2,5	2,6	2,8	3,0	3,2	3,4	3,5	3,7	4,0	4,3	4,6	4,8	5,0
375	490	560	625	685	710	790	840	865	890	915	935	960	980											
415	545	625	695	760	790	880	935	960	990	1015	1040	1065	<b>1090</b>											
580	765	870	970	1065	1105	1230	1310	1345	1385	1420	1455	1490	1525											
265	350	400	445	485	505	565	600	615	635	650	665	680	700											
295	390	445	495	540	560	625	665	685	705	720	740	755	<b>775</b>											
350	465	525	585	645	670	745	790	815	835	860	880	900	920											
415	545	620	690	755	785	875	930	960	985	1010	1035	1060	1085											
465	615	700	780	850	885	985	1050	1080	1110	1135	1165	1190	1220	1275	1335	1380	1425							

7	12	14	17	20	22	26	29	32	35	38	41	43	46	51	52	54	58	62	67	70	72	75	
0,5	0,8	1,0	1,2	1,4	1,5	1,8	2,0	2,2	2,4	2,6	2,8	3,0	3,2	3,5	3,6	3,7	4,0	4,3	4,6	4,8	5,0	5,2	
540	715	815	905	990	1030	1145	1220	1290	1355	1420	1485												
600	795	905	1005	1100	1145	1275	1355	1435	1510	1580	<b>1650</b>												
845	1110	1265	1405	1540	1605	1785	1895	2005	2110	2210	2310												
380	500	565	630	690	720	800	850	900	945	990	1035												
420	555	630	700	765	800	890	945	1000	1050	1100	<b>1150</b>												
500	660	750	835	915	950	1055	1125	1190	1250	1310	1370												
590	775	880	980	1075	1115	1245	1325	1400	1470	1540	1610												
660	875	995	1105	1205	1260	1405	1490	1575	1655	1735	1815	1885	1965	2065	2095								

### IM110 - IM220

X-ply tire for tractors, crop processing and green area equipment



SIZE	LI/SS	New tire		Tire in service				Rim	Permitted rims	Tube	Speed Km/h	PRESSURE	
		SW mm +/-1.5%	OD mm +/-1.5%	SW max mm	OD max mm	SLR mm +/-2%	RC mm +/-2.5%					psi bar	MAX. LOAD kg
7.50-18 6PR IM110	106A8 ↻	203	870	225	875	399	2626	5.50F	4-50E 5.00F-6.00F	7.50-18 TR15	Free Rolling		
	94A8 ↻												
											40		
											10		
											Driving wheel		
											50		
											40		
											25		
											10		
											10 C		

SIZE	LI/SS	New tire		Tire in service				Rim	Permitted rims	Tube	Speed Km/h	PRESSURE	
		SW mm +/-1.5%	OD mm +/-1.5%	SW max mm	OD max mm	SLR mm +/-2%	RC mm +/-2.5%					psi bar	MAX. LOAD kg
250/80-18 8PR IM110	127A8 ↻	240	875	271	885	386	2589	W8	W7-W9-9-9.00	7.50-18 TR15	Free Rolling		
	115A8 ↻												
											40		
											10		
											Driving wheel		
											50		
											40		
											25		
											10		
											10 C		

SIZE	LI/SS	New tire		Tire in service				Rim	Permitted rims	Tube	Speed Km/h	PRESSURE	
		SW mm +/-1.5%	OD mm +/-1.5%	SW max mm	OD max mm	SLR mm +/-2%	RC mm +/-2.5%					psi bar	MAX. LOAD kg
4.50-19 2PR IM110	66A8 ↻	120	740	130	748	342	2234	3.00D	3.50D	4.00-19 TR15	Free Rolling		
	54A8 ↻												
											40		
											10		
											Driving wheel		
											50		
											40		
											25		
											10		
											10 C		

SIZE	LI/SS	New tire		Tire in service				Rim	Permitted rims	Tube	Speed Km/h	PRESSURE	
		SW mm +/-1.5%	OD mm +/-1.5%	SW max mm	OD max mm	SLR mm +/-2%	RC mm +/-2.5%					psi bar	MAX. LOAD kg
4.00-21 2PR IM110	66A8 ↻	110	765	115	777	358	2330	3.00D	2.50C	4.00-21	Free Rolling		
	54A8 ↻												
											40		
											10		
											Driving wheel		
											50		
											40		
											25		
											10		
											10 C		



7	12	14	17	20	22	26	29	30	32	33	35	38	41	43	46	51	54	58	61	62	67	70	72	75
0,5	0,8	1,0	1,2	1,4	1,5	1,8	2,0	2,1	2,2	2,3	2,4	2,6	2,8	3,0	3,2	3,5	3,7	4,0	4,2	4,3	4,6	4,8	5,0	5,2
350	460	525	585	640	665	740	790	810	835	855														
390	510	585	650	710	740	825	875	900	925	<b>950</b>														
545	715	820	910	995	1035	1150	1225	1260	1295	1330														
245	325	370	410	450	470	520	555	570	590	605														
275	360	410	460	500	520	580	615	635	655	<b>670</b>														
325	430	490	545	595	620	690	735	755	775	795														
385	505	575	640	700	730	810	865	890	915	940														
435	570	645	725	790	820	915	970	1000	1035	1055	1080	1135	1185	1240										

7	12	14	17	20	22	26	29	32	35	38	41	43	46	52	54	58	62	67	70	72				
0,5	0,8	1,0	1,2	1,4	1,5	1,8	2,0	2,2	2,4	2,6	2,8	3,0	3,2	3,6	3,7	4,0	4,3	4,6	4,8	5,0				
575	755	860	960	1050	1095	1215	1295	1370	1440	1510	1575													
640	840	960	1065	1165	1215	1350	1435	1520	1600	1675	<b>1750</b>													
895	1175	1340	1490	1635	1700	1890	2010	2130	2240	2345	2450													
400	525	600	665	730	760	845	900	950	1000	1045	1095													
445	585	665	740	810	845	940	1000	1055	1110	1165	<b>1215</b>													
525	695	790	880	965	1005	1115	1190	1255	1320	1385	1445													
620	820	930	1035	1135	1180	1315	1395	1475	1555	1630	1700													
700	925	1050	1165	1275	1335	1480	1575	1665	1750	1835	1915	1995	2075	2215										

7	12	14	17	20	23	26	29	30	32	33	35	36	38	41	42
0,5	0,8	1,0	1,2	1,4	1,6	1,8	2,0	2,1	2,2	2,3	2,4	2,5	2,6	2,8	2,9
160	215	245	270												
180	235	270	<b>300</b>												
250	330	380	420												
115	150	170	190												
125	165	190	<b>210</b>												
150	200	225	250												
180	235	265	295												
195	260	300	330	365	395										

7	12	14	17	20	22	26	29	30	32	33	35	36	38	41	42
0,5	0,8	1,0	1,2	1,4	1,5	1,8	2,0	2,1	2,2	2,3	2,4	2,5	2,6	2,8	2,9
140	185	215	235	260	270										
160	210	235	265	290	<b>300</b>										
220	290	330	370	405	420										
100	130	150	165	185	190										
110	145	165	185	205	<b>210</b>										
130	175	200	220	245	250										
155	205	235	260	285	295										
175	230	260	290	325	330	370	395								

## IM110 - IM220

X-ply tire for tractors, crop processing and green area equipment



SIZE	LI/SS	New tire		Tire in service				Rim	Permitted rims	Tube	Speed Km/h	PRESSURE		
		SW mm +/-1.5%	OD mm +/-1.5%	SW max mm	OD max mm	SLR mm +/-2%	RC mm +/-2.5%					psi	bar	
210/95-20 IM220	119A8 ⊖→	214	907	224	922	417	2746	W6			Free Rolling			
											50			
											40			
											10			
	107A8 ⊖						427	2775				Driving wheel		
												50		
												40		
												25		
											10			
											10 C			

7	12	14	17	20	23	26	29	30	32	35	38	41	43	46	51
0,5	0,8	1,0	1,2	1,4	1,6	1,8	2,0	2,1	2,2	2,4	2,6	2,8	3,0	3,2	3,5
460	585	665	745	835	925	995	1060	1105	1145	1225					
510	650	740	825	925	1030	1105	1180	1225	1270	<b>1360</b>					
675	840	950	1060	1165	1290	1420	1520	1565	1610	1705	1815	1925			
325	415	470	520	590	655	710	765	795	820	880					
365	460	520	580	655	730	790	850	880	915	<b>975</b>					
430	550	620	690	780	870	940	1010	1050	1085	1160					
480	600	675	750	820	910	1005	1085	1120	1155	1230	1305	1380			
625	760	850	940	1020	1105	1185	1295	1350	1395	1490	1575	1660	1740	1830	1960

For technical notes about pressure tables please refer to page 260.

### IM110 - IM220

X-ply tire for tractors, crop processing and green area equipment



# TM3000

**BLUE TIRE**  
TECHNOLOGY



The TM3000, designed using the **BLUE TIRE** technology, is Trelleborg's answer to the latest and future generations of harvesters, combines and spreader machines. A new tread pattern, along with the advanced carcass design, maximises

the load capacity of the tire at low inflation pressure, preserving the soil and the environment.

Matching sustainable and precision farming approaches, the TM3000 is the right choice to boost harvesting productivity.

## SIZE

<b>VF 1000/50R25 *</b>	<b>184D</b>
<b>VF 620/70R26</b>	<b>CF0 173A8</b>
<b>VF 750/50R26 *</b>	<b>169D</b>
<b>VF 750/65R26</b>	<b>CF0 177A8 (177B)</b>
<b>650/75R32</b>	<b>172A8</b>

## SIZE

<b>IF 800/65R32 °</b>	<b>CF0 178A8</b>
<b>IF 800/70R32 °</b>	<b>CF0 182A8</b>
<b>IF 900/65R32 °</b>	<b>CF0 191A8 (191B)</b>
<b>VF 1050/50R32 *°</b>	<b>198D</b>
<b>IF 800/70R38 °</b>	<b>CF0 187A8</b>

\* = spreader

° = for grain cart application also

SIZE	Tread pattern	SW mm	OD mm	SLR mm	RC mm	SRI	Rim	Permitted Rims	Type	Tube
<b>VF 1000/50R25</b> 184D	<b>TM3000</b>	1030	1640	710	4870	775	36.0 TH		TUBELESS	
<b>PRESSURE</b>										
<b>psi</b>		<b>14</b>	<b>17</b>	<b>20</b>	<b>23</b>	<b>26</b>	<b>29</b>	<b>32</b>	<b>35</b>	
<b>bar</b>		<b>1,0</b>	<b>1,2</b>	<b>1,4</b>	<b>1,6</b>	<b>1,8</b>	<b>2,0</b>	<b>2,2</b>	<b>2,4</b>	
<b>MAX. LOAD kg</b>										
<b>Up to 65 Km/h (*)</b>		5490	6120	6840	7470	7920	8370	8685	<b>9000</b>	
<b>Field Service (*)</b>		5490	6120	6840	7470	7920	8370	8685	<b>9000</b>	

**Design data** = the dimensions of size in design data are calculated dimensions and not measured data on the normal production tire

SIZE	Tread pattern	SW mm	OD mm	SLR mm	RC mm	SRI	Rim	Permitted Rims	Type	Tube
<b>VF 620/70R26 CF0</b> 173A8	<b>TM3000</b>	595	1500	645	4530	725	DW20B		TUBELESS	
<b>PRESSURE</b>										
<b>psi</b>		<b>17</b>	<b>20</b>	<b>23</b>	<b>26</b>	<b>29</b>	<b>32</b>	<b>35</b>	<b>38</b>	<b>41</b>
<b>bar</b>		<b>1,2</b>	<b>1,4</b>	<b>1,6</b>	<b>1,8</b>	<b>2,0</b>	<b>2,2</b>	<b>2,4</b>	<b>2,6</b>	<b>2,8</b>
<b>MAX. LOAD kg</b>										
<b>Up to 40 Km/h (S)</b>		4160	4615	5070	5330	5590	5755	5915	6210	<b>6500</b>
<b>15 Cyc (*)</b>		5535	6140	6745	7090	7435	7655	7870	8260	8645

SIZE	Tread pattern	SW mm	OD mm	SLR mm	RC mm	SRI	Rim	Permitted Rims	Type	Tube
VF 750/50R26 169D	TM3000	750	1415	615	4230	675	DW27B	DW25B	TUBELESS	
<b>PRESSURE</b>										
psi			<b>14</b>	<b>17</b>	<b>20</b>	<b>23</b>	<b>26</b>	<b>29</b>	<b>32</b>	<b>35</b>
bar			<b>1</b>	<b>1,2</b>	<b>1,4</b>	<b>1,6</b>	<b>1,8</b>	<b>2</b>	<b>2,2</b>	<b>2,4</b>
<b>MAX. LOAD kg</b>										
Up to 65 Km/h (*)			3485	3920	4355	4790	5065	5315	5540	<b>5800</b>
Field Service (*)			3485	3920	4355	4790	5065	5315	5540	5800

SIZE	Tread pattern	SW mm	OD mm	SLR mm	RC mm	SRI	Rim	Permitted Rims	Type	Tube
VF 750/65R26 CFO 177A8 (177B)	TM3000	740	1649	710	4882	775	DW25B	DW25B	TUBELESS	
<b>PRESSURE</b>										
psi			<b>17</b>	<b>20</b>	<b>23</b>	<b>26</b>	<b>29</b>	<b>32</b>	<b>35</b>	
bar			<b>1,2</b>	<b>1,4</b>	<b>1,6</b>	<b>1,8</b>	<b>2</b>	<b>2,2</b>	<b>2,4</b>	
<b>MAX. LOAD kg</b>										
Up to 40 Km/h (*)			5110	5625	6060	6425	6790	7045	7300	
15 Cyc (*)			6800	7485	8060	8550	9035	9370	9710	

SIZE	Tread pattern	SW mm	OD mm	SLR mm	RC mm	SRI	Rim	Permitted Rims	Type	Tube		
650/75R32 172A8	TM3000	618	1817	820	5500	850	DW20B		TUBELESS			
<b>PRESSURE</b>												
psi			<b>12</b>	<b>14</b>	<b>20</b>	<b>23</b>	<b>29</b>	<b>35</b>	<b>41</b>	<b>46</b>	<b>49</b>	<b>55</b>
bar			<b>0,8</b>	<b>1,0</b>	<b>1,4</b>	<b>1,6</b>	<b>2,0</b>	<b>2,4</b>	<b>2,8</b>	<b>3,2</b>	<b>3,4</b>	<b>3,8</b>
<b>MAX. LOAD kg</b>												
<b>40 S</b>			3010	3385	4110	4500	4900	5300	5820	<b>6300</b>		
30 S			3220	3620	4395	4770	5245	5715	6230	6740		
10 LT S			3870	4515	5635	6160	7020	7680	8370	9090	9270	9450
10 HT S			3220	3620	4395	4770	5245	5715	6230	6740		
10 Cyc S				4750	6070	6685	7765	8520	9285	10100	10305	10710

SIZE	Tread pattern	SW mm	OD mm	SLR mm	RC mm	SRI	Rim	Permitted Rims	Type	Tube
IF 800/65R32 CFO 178A8	TM3000	755	1850	810	5575	875	DW27B		TUBELESS	
<b>PRESSURE</b>										
psi			<b>17</b>	<b>20</b>	<b>23</b>	<b>26</b>	<b>29</b>	<b>32</b>	<b>35</b>	
bar			<b>1,2</b>	<b>1,4</b>	<b>1,6</b>	<b>1,8</b>	<b>2,0</b>	<b>2,2</b>	<b>2,4</b>	
<b>MAX. LOAD kg</b>										
Up to 40 Km/h (S)			5250	5775	6225	6565	6900	7200	<b>7500</b>	
15 Cyc (*)			8140	8955	9650	10175	10695	11160	11625	

### TM3000

Radial tire for harvesters, sprayers and spreaders



SIZE	Tread pattern	SW mm	OD mm	SLR mm	RC mm	SRI	Rim	Permitted Rims	Type	Tube
IF 800/70R32 CFO 182A8	TM3000	775	1950	850	5845	900	DW27B		TUBELESS	
<b>PRESSURE</b>										
psi			<b>17</b>	<b>20</b>	<b>23</b>	<b>26</b>	<b>26</b>	<b>29</b>	<b>32</b>	<b>35</b>
bar			<b>1,2</b>	<b>1,4</b>	<b>1,6</b>	<b>1,6</b>	<b>1,8</b>	<b>2,0</b>	<b>2,2</b>	<b>2,4</b>
<b>MAX. LOAD kg</b>										
<b>Up to 40 Km/h (S)</b>			5780	6460	7140	7480	7820	8160	<b>8500</b>	
15 Cyc (*)			8960	10015	11070	11595	12125	12650	13175	

SIZE	Tread pattern	SW mm	OD mm	SLR mm	RC mm	SRI	Rim	Permitted Rims	Type	Tube
IF 900/65R32 CFO 191A8 (191B)	TM3000	900	1985	875	5975	925	DW31B	DW30B	TUBELESS	
<b>PRESSURE</b>										
psi			<b>17</b>	<b>20</b>	<b>23</b>	<b>29</b>	<b>35</b>	<b>41</b>	<b>46</b>	
bar			<b>1,2</b>	<b>1,4</b>	<b>1,6</b>	<b>2</b>	<b>2,4</b>	<b>2,8</b>	<b>3,2</b>	
<b>MAX. LOAD kg</b>										
<b>Up to 40 Km/h (S)</b>			6540	7085	7740	8610	9265	10135	<b>10900</b>	
15 Cyc (*)			10135	10980	11995	13345	14360	15710	16895	

**Design data** = the dimensions of size in design data are calculated dimensions and not measured data on the normal production tire

SIZE	Tread pattern	SW mm	OD mm	SLR mm	RC mm	SRI	Rim	Permitted Rims	Type	Tube
VF 1050/50R32 198D	TM3000	1035	1860	820	5570	875	36.00 VA		TUBELESS	
<b>PRESSURE</b>										
psi			<b>14</b>	<b>17</b>	<b>23</b>	<b>29</b>	<b>35</b>	<b>41</b>	<b>46</b>	<b>52</b>
bar			<b>1,0</b>	<b>1,2</b>	<b>1,6</b>	<b>2,0</b>	<b>2,4</b>	<b>2,8</b>	<b>3,2</b>	<b>3,6</b>
<b>MAX. LOAD kg</b>										
<b>Up to 65 Km/h (*)</b>			6500	7335	9000	10000	10600	11800	12500	<b>13200</b>
<b>Field Service (*)</b>			6500	7335	9000	10000	10600	11800	12500	<b>13200</b>

SIZE	Tread pattern	SW mm	OD mm	SLR mm	RC mm	SRI	Rim	Permitted Rims	Type	Tube
IF 800/70R38 CFO 187A8	TM3000	780	2050	910	6190	975	DW27B		TUBELESS	
<b>PRESSURE</b>										
psi			<b>17</b>	<b>20</b>	<b>23</b>	<b>26</b>	<b>29</b>	<b>32</b>	<b>35</b>	<b>38</b>
bar			<b>1,2</b>	<b>1,4</b>	<b>1,6</b>	<b>1,8</b>	<b>2,0</b>	<b>2,2</b>	<b>2,4</b>	<b>2,6</b>
<b>MAX. LOAD kg</b>										
<b>Up to 40 Km/h (S)</b>			6300	7020	7740	8100	8385	8630	8875	9315
15 Cyc (*)			9765	10885	12000	12555	13000	13380	13760	14440

For technical notes about pressure tables please refer to page 260.

## TM3000



# TM2000

Radial tire for harvesting and combine machines, the result of the advanced technology and experience of Trelleborg in agricultural tires.

Product plus:

- high load capacity even at low pressure. The extensive footprint area allows a greater load to be carried for a given inflation pressure compared to standard tires
- excellent traction capacity due to the flexible radial carcass and deep tractive lugs



- maximum resistance to impact and puncturing ensured by the high quality materials used
- optimal lateral stability even on difficult and very uneven terrain
- low vibration levels and high comfort in all working conditions

## SIZE

**620/75R26 166A8 (23.1R26)**

**650/75R32 172A8 (24.5R32)**

**710/75R32 177A8**

## SIZE

**800/65R32 178A8 (30.5LR32)**

**900/60R32 181A8**

SIZE	Tread pattern	SW mm	OD mm	SLR mm	RC mm	SRI	Rim	Permitted Rims	Type	Tube
<b>620/75R26</b> 166A8 (23.1R26)	<b>TM2000</b>	633	1590	716	4850	750	DW20B		TUBELESS	

### PRESSURE

psi	<b>12</b>	<b>14</b>	<b>20</b>	<b>23</b>	<b>29</b>	<b>35</b>	<b>41</b>	<b>46</b>	<b>49</b>	<b>55</b>
bar	<b>0,8</b>	<b>1,0</b>	<b>1,4</b>	<b>1,6</b>	<b>2,0</b>	<b>2,4</b>	<b>2,8</b>	<b>3,2</b>	<b>3,4</b>	<b>3,8</b>

### MAX. LOAD kg

<b>40 S</b>	2530	2845	3455	3750	4120	4500	4900	<b>5300</b>		
30 S	2710	3045	3700	4015	4410	4810	5240	5670		
10 LT S	3255	3795	4740	5185	5905	6460	7045	7650	7800	7950
10 HT S	2710	3045	3700	4015	4410	4810	5240	5670		
10 Cyc S		3995	5110	5625	6535	7165	7810	8495	8670	9010

## TM2000

Radial tire for harvesters



SIZE	Tread pattern	SW mm	OD mm	SLR mm	RC mm	SRI	Rim	Permitted Rims	Type	Tube
<b>650/75R32</b> 172A8 (24.5R32)	<b>TM2000</b>	662	1817	805	5495	850	DW20B		TUBELESS	24.5-32

**PRESSURE**

psi	<b>12</b>	<b>14</b>	<b>20</b>	<b>23</b>	<b>29</b>	<b>35</b>	<b>41</b>	<b>46</b>	<b>49</b>	<b>55</b>
bar	<b>0,8</b>	<b>1,0</b>	<b>1,4</b>	<b>1,6</b>	<b>2,0</b>	<b>2,4</b>	<b>2,8</b>	<b>3,2</b>	<b>3,4</b>	<b>3,8</b>

**MAX. LOAD kg**

<b>40 S</b>	3010	3385	4110	4500	4900	5300	5820	<b>6300</b>		
30 S	3220	3620	4395	4770	5245	5715	6230	6740		
10 LT S	3870	4515	5635	6160	7020	7680	8370	9090	9270	9450
10 HT S	3220	3620	4395	4770	5245	5715	6230	6740		
10 Cyc S		4750	6070	6685	7765	8520	9285	10100	10305	10710

SIZE	Tread pattern	SW mm	OD mm	SLR mm	RC mm	SRI	Rim	Permitted Rims	Type	Tube
<b>710/75R32</b> 177A8	<b>TM2000</b>	735	1850	830	5595	850	DW23B	DW21B	TUBELESS	30.5-32

**PRESSURE**

psi	<b>12</b>	<b>14</b>	<b>20</b>	<b>23</b>	<b>29</b>	<b>35</b>	<b>41</b>	<b>46</b>	<b>49</b>	<b>55</b>
bar	<b>0,8</b>	<b>1,0</b>	<b>1,4</b>	<b>1,6</b>	<b>2,0</b>	<b>2,4</b>	<b>2,8</b>	<b>3,2</b>	<b>3,4</b>	<b>3,8</b>

**MAX. LOAD kg**

<b>40 S</b>	3490	3925	4760	5170	5680	6195	6750	<b>7300</b>		
30 S	3735	4195	5095	5530	6080	6625	7220	7815		
10 LT S	4170	4860	6210	6840	7945	8715	9495	10330	10540	10950
10 HT S	3735	4195	5095	5530	6080	6625	7220	7815		
10 Cyc S		5510	7040	7755	9005	9880	10765	11705	11945	12410

SIZE	Tread pattern	SW mm	OD mm	SLR mm	RC mm	SRI	Rim	Permitted Rims	Type	Tube
<b>800/65R32</b> 178A8	<b>TM2000</b>	800	1846	829	5595	875	DW27B	DW25B - DH27 - DW28B	TUBELESS	30.5-32

**PRESSURE**

psi	<b>12</b>	<b>14</b>	<b>20</b>	<b>23</b>	<b>29</b>	<b>35</b>	<b>41</b>	<b>46</b>	<b>49</b>	<b>55</b>
bar	<b>0,8</b>	<b>1,0</b>	<b>1,4</b>	<b>1,6</b>	<b>2,0</b>	<b>2,4</b>	<b>2,8</b>	<b>3,2</b>	<b>3,4</b>	<b>3,8</b>

**MAX. LOAD kg**

<b>40 S</b>	3580	4030	4890	5300	5835	6300	6930	<b>7500</b>		
30 S	3835	4310	5235	5680	6240	6805	7415	8025		
10 LT S	4605	5373	6710	7335	8355	9145	9965	10820	11035	11250
10 HT S	3835	4310	5235	5680	6240	6805	7415	8025		
10 Cyc S		5655	7230	7960	9250	10140	11055	12025	12265	12750



SIZE	Tread pattern	SW mm	OD mm	SLR mm	RC mm	SRI	Rim	Permitted Rims	Type	Tube
900/60R32 181A8	TM2000	890	1900	855	5765	900	DW30B	DW27B - DW28B	TUBELESS	30.5-32

#### PRESSURE

psi	<b>12</b>	<b>14</b>	<b>20</b>	<b>23</b>	<b>29</b>	<b>35</b>	<b>41</b>	<b>46</b>	<b>49</b>	<b>55</b>
bar	<b>0,8</b>	<b>1,0</b>	<b>1,4</b>	<b>1,6</b>	<b>2,0</b>	<b>2,4</b>	<b>2,8</b>	<b>3,2</b>	<b>3,4</b>	<b>3,8</b>

#### MAX. LOAD kg

<b>40 S</b>	3795	4290	5280	5860	6520	7015	7675	<b>8250</b>		
30 S	4065	4595	5650	6270	6975	7505	8210	8830		
10 LT S	5165	5835	7185	7970	8865	9540	10435	11220	11470	12375
10 HT S	4065	4595	5650	6270	6975	7505	8210	8830		
10 Cyc S		6480	7975	8845	9845	10590	11590	12460	13010	14025

For technical notes about pressure tables please refer to page 260.

### TM2000

Radial tire for harvesters



# HF1000



The VF and steel belted HF1000 has been designed for big forage wagons and slurry tankers. It ensures long durability and superior performance both in the field and on the road. In the field, it stands out with its excellent flotation and self-cleaning features. On the road, it delivers a comfortable

ride and easy handling while providing increased stability and overall driveability.

## SIZE

**VF 750/60R30.5 IMP 187D**

**VF 800/60R32 IMP 191D**

SIZE	Tread pattern	SW mm	OD mm	SLR mm	RC mm	SRI	Rim	Permitted Rims	Type	Tube
VF750/60R30.5 IMP 187D	HF1000	790	1685	727	4955	800	AG24.00		TUBELESS	

### PRESSURE

psi	<b>12</b>	<b>15</b>	<b>17</b>	<b>22</b>	<b>26</b>	<b>29</b>	<b>35</b>	<b>41</b>	<b>46</b>
bar	<b>0,8</b>	<b>1,0</b>	<b>1,2</b>	<b>1,5</b>	<b>1,8</b>	<b>2,0</b>	<b>2,4</b>	<b>2,8</b>	<b>3,2</b>

### MAX. LOAD kg

<b>65 S</b>	3890	4450	5000	5690	6350	6780	7820	8870	<b>9750</b>
50 S	4550	5210	5850	6660	7430	7930	9150	10380	11410
40 S	5020	5740	6450	7340	8190	8750	10090	11440	12580
25 S	5680	6500	7300	8310	9270	9900	11420	12950	14240
10 S	6380	7300	8200	9330	10410	11120	12820	14550	15990

SIZE	Tread pattern	SW mm	OD mm	SLR mm	RC mm	SRI	Rim	Permitted Rims	Type	Tube
VF800/60R32 IMP 191D	HF1000	795	1800	780	5415	875	DW27B		TUBELESS	

### PRESSURE

psi	<b>12</b>	<b>15</b>	<b>17</b>	<b>22</b>	<b>26</b>	<b>29</b>	<b>35</b>	<b>41</b>	<b>46</b>
bar	<b>0,8</b>	<b>1,0</b>	<b>1,2</b>	<b>1,5</b>	<b>1,8</b>	<b>2,0</b>	<b>2,4</b>	<b>2,8</b>	<b>3,2</b>

### MAX. LOAD kg

<b>65 S</b>	4340	4970	5590	6360	7100	7580	8750	9910	<b>10900</b>
50 S	5080	5810	6540	7440	8310	8870	10240	11590	12750
40 S	5600	6410	7210	8200	9160	9780	11290	12780	14060
25 S	6340	7260	8160	9290	10370	11070	12780	14470	15910
10 S	7120	8150	9170	10430	11640	12430	14350	16250	17880

**Design data** = the dimensions of size in design data are calculated dimensions and not measured data on the normal production tire

For technical notes about pressure tables please refer to page 260.

## HF1000



# TWIN RADIAL

Radial implement tire, perfect in all working conditions and on any type of soil.

Product plus:

- excellent ground care due to the wide area of footprint and the rounded profile of the shoulder. The central “block structure” enables the tire to self-clean efficiently and rapidly
- high speed and maximised road handling even in high stress conditions
- high load capacity and excellent



- traction when used as a drive wheel and at the same time offering minimum rolling resistance when in free-rolling mode
- great comfort and excellent even wear due to the sidewall profile and tread design

## SIZE

**500/60R22.5 155D**

**560/60R22.5 161D**

**580/65R22.5 159D**

**600/50R22.5 159D**

**600/55R26.5 165D**

**680/55R26.5 171D**

## SIZE

**710/50R26.5 170D**

**650/65R30.5 176D**

**750/60R30.5 181D**

**850/50R30.5 182D**

**800/60R32 185D**

## TWIN RADIAL

Radial tire for transport equipment



SIZE	Tread pattern	SW mm	OD mm	SLR mm	RC mm	SRI	Rim	Permitted Rims	Type	Tube	
<b>500/60R22.5</b> 155D	<b>Twin Radial</b>	520	1192	537	3600	550	AG16.00	15.00 - 16.00 - 17.00	TUBELESS		
<b>PRESSURE</b>											
<b>psi</b>		<b>14</b>	<b>17</b>	<b>22</b>	<b>26</b>	<b>29</b>	<b>35</b>	<b>41</b>	<b>46</b>	<b>52</b>	<b>58</b>
<b>bar</b>		<b>1,0</b>	<b>1,2</b>	<b>1,5</b>	<b>1,8</b>	<b>2,0</b>	<b>2,4</b>	<b>2,8</b>	<b>3,2</b>	<b>3,6</b>	<b>4,0</b>
<b>MAX. LOAD kg</b>											
<b>65 S</b>		1730	1930	2235	2535	2735	3140	3325	3510	3695	<b>3880</b>
50 S		2070	2315	2690	3060	3305	3800	4020	4245	4470	4690
40 S		2330	2605	3025	3440	3715	4270	4520	4770	5020	5270
25 S		2680	3005	3495	3985	4310	4960	5250	5540	5830	6120
10 S		3160	3515	4050	4585	4940	5650	5980	6315	6650	6980

SIZE	Tread pattern	SW mm	OD mm	SLR mm	RC mm	SRI	Rim	Permitted Rims	Type	Tube	
<b>560/60R22.5</b> 161D	<b>Twin Radial</b>	552	1240	559	3824	600	AG16.00	16.00 - 17.00	TUBELESS		
<b>PRESSURE</b>											
<b>psi</b>		<b>14</b>	<b>17</b>	<b>22</b>	<b>26</b>	<b>29</b>	<b>35</b>	<b>41</b>	<b>46</b>	<b>52</b>	<b>58</b>
<b>bar</b>		<b>1,0</b>	<b>1,2</b>	<b>1,5</b>	<b>1,8</b>	<b>2,0</b>	<b>2,4</b>	<b>2,8</b>	<b>3,2</b>	<b>3,6</b>	<b>4,0</b>
<b>MAX. LOAD kg</b>											
<b>65 S</b>		2070	2310	2670	3030	3270	3750	3970	4190	4410	<b>4630</b>
50 S		2470	2765	3205	3645	3940	4530	4800	5065	5330	5600
40 S		2790	3120	3610	4105	4435	5090	5390	5690	5990	6290
25 S		3190	3580	4160	4745	5135	5910	6260	6610	6960	7310
10 S		3780	4205	4840	5475	5900	6750	7145	7540	7935	8330

SIZE	Tread pattern	SW mm	OD mm	SLR mm	RC mm	SRI	Rim	Permitted Rims	Type	Tube		
<b>580/65R22.5</b> 159D	<b>Twin Radial</b>	583	1300	586	3950	625	AG16.00	16.00 - 17.00 - AG20.00	TUBELESS			
<b>PRESSURE</b>												
psi			<b>12</b>	<b>14</b>	<b>20</b>	<b>23</b>	<b>26</b>	<b>29</b>	<b>35</b>	<b>41</b>	<b>43</b>	<b>46</b>
bar			<b>0,8</b>	<b>1,0</b>	<b>1,4</b>	<b>1,6</b>	<b>1,8</b>	<b>2,0</b>	<b>2,4</b>	<b>2,8</b>	<b>3,0</b>	<b>3,2(*)</b>
<b>MAX. LOAD kg</b>												
<b>65 S</b>			1875	2105	2575	2810	2990	3170	3625	4075	4225	<b>4375</b>
50 S			2265	2550	3115	3400	3615	3835	4385	4930	5115	5295
40 S			2545	2865	3500	3820	4065	4310	4925	5540	5745	5950
30 S			2825	3180	3885	4240	4515	4785	5470	6155	6380	6610
10 S			3370	3790	4630	5055	5380	5705	6520	7335	7605	7875

(\*) = the inflation pressure can be increased up to 4,0 bar.

SIZE	Tread pattern	SW mm	OD mm	SLR mm	RC mm	SRI	Rim	Permitted Rims	Type	Tube		
<b>600/50R22.5</b> 159D	<b>Twin Radial</b>	600	1170	530	3550	550	AG20.00		TUBELESS			
<b>PRESSURE</b>												
psi			<b>14</b>	<b>17</b>	<b>22</b>	<b>26</b>	<b>29</b>	<b>35</b>	<b>41</b>	<b>46</b>	<b>52</b>	<b>58</b>
bar			<b>1,0</b>	<b>1,2</b>	<b>1,5</b>	<b>1,8</b>	<b>2,0</b>	<b>2,4</b>	<b>2,8</b>	<b>3,2</b>	<b>3,6</b>	<b>4,0</b>
<b>MAX. LOAD kg</b>												
<b>65 S</b>			1950	2175	2520	2860	3085	3540	3750	3960	4170	<b>4380</b>
50 S			2340	2620	3035	3455	3735	4290	4540	4790	5040	5290
40 S			2640	2950	3420	3885	4195	4820	5100	5385	5670	5950
25 S			3020	3385	3940	4490	4855	5590	5920	6250	6580	6910
10 S			3570	3970	4575	5175	5575	6380	6755	7130	7505	7880

## TWIN RADIAL

Radial tire for transport equipment



SIZE	Tread pattern	SW mm	OD mm	SLR mm	RC mm	SRI	Rim	Permitted Rims	Type	Tube
<b>600/55R26.5</b> 165D	Twin Radial	636	1341	605	4110	625	AG20.00		TUBELESS	

**PRESSURE**

<b>psi</b>	<b>14</b>	<b>17</b>	<b>22</b>	<b>26</b>	<b>29</b>	<b>35</b>	<b>41</b>	<b>46</b>	<b>52</b>	<b>58</b>
<b>bar</b>	<b>1,0</b>	<b>1,2</b>	<b>1,5</b>	<b>1,8</b>	<b>2,0</b>	<b>2,4</b>	<b>2,8</b>	<b>3,2</b>	<b>3,6</b>	<b>4,0</b>

**MAX. LOAD kg**

<b>65 S</b>	2300	2565	2970	3370	3635	4170	4415	4660	4905	<b>5150</b>
50 S	2750	3080	3570	4065	4395	5050	5345	5640	5935	6230
40 S	3100	3465	4020	4570	4935	5670	6000	6335	6670	7000
25 S	3560	3995	4640	5290	5725	6590	6980	7365	7750	8140
10 S	4200	4675	5380	6090	6565	7510	7950	8390	8830	9270

SIZE	Tread pattern	SW mm	OD mm	SLR mm	RC mm	SRI	Rim	Permitted Rims	Type	Tube
<b>680/55R26.5</b> 171D	Twin Radial	685	1420	631	4335	675	AG20.00	AG24.00	TUBELESS	

**PRESSURE**

<b>psi</b>	<b>12</b>	<b>14</b>	<b>20</b>	<b>23</b>	<b>29</b>	<b>38</b>	<b>43</b>	<b>46</b>	<b>52</b>	<b>58</b>
<b>bar</b>	<b>0,8</b>	<b>1,0</b>	<b>1,4</b>	<b>1,6</b>	<b>2,0</b>	<b>2,6</b>	<b>3,0</b>	<b>3,2</b>	<b>3,6</b>	<b>4,0</b>

**MAX. LOAD kg**

<b>65 S</b>	1970	2245	2830	3140	3570	4510	4890	5105	5600	<b>6150</b>
50 S	2385	2720	3425	3800	4320	5455	5920	6180	6775	7445
40 S	2680	3055	3850	4270	4855	6130	6650	6945	7615	8365
30 S	2975	3390	4275	4740	5390	6805	7385	7710	8455	9290
10 S	3545	4045	5095	5650	6425	8115	8805	9190	10075	11070

SIZE	Tread pattern	SW mm	OD mm	SLR mm	RC mm	SRI	Rim	Permitted Rims	Type	Tube
<b>710/50R26.5</b> 170D	Twin Radial	710	1355	610	4120	650	AG24.00		TUBELESS	

**PRESSURE**

<b>psi</b>	<b>14</b>	<b>17</b>	<b>22</b>	<b>26</b>	<b>29</b>	<b>35</b>	<b>41</b>	<b>46</b>	<b>52</b>	<b>58</b>
<b>bar</b>	<b>1,0</b>	<b>1,2</b>	<b>1,5</b>	<b>1,8</b>	<b>2,0</b>	<b>2,4</b>	<b>2,8</b>	<b>3,2</b>	<b>3,6</b>	<b>4,0</b>

**MAX. LOAD kg**

<b>65 S</b>	2680	2990	3460	3925	4235	4860	5145	5430	5715	<b>6000</b>
50 S	3200	3585	4155	4730	5115	5880	6225	6570	6915	7260
40 S	3610	4040	4680	5325	5755	6610	7000	7385	7770	8160
25 S	4140	4645	5400	6155	6660	7670	8120	8575	9030	9480
10 S	4900	5450	6275	7100	7650	8750	9260	9775	10290	10800

SIZE	Tread pattern	SW mm	OD mm	SLR mm	RC mm	SRI	Rim	Permitted Rims	Type	Tube	
<b>650/65R30.5</b> 176D	Twin Radial	675	1635	735	4975	775	AG20.00		TUBELESS		
<b>PRESSURE</b>											
psi		<b>14</b>	<b>17</b>	<b>22</b>	<b>26</b>	<b>29</b>	<b>35</b>	<b>41</b>	<b>46</b>	<b>52</b>	<b>58</b>
bar		<b>1,0</b>	<b>1,2</b>	<b>1,5</b>	<b>1,8</b>	<b>2,0</b>	<b>2,4</b>	<b>2,8</b>	<b>3,2</b>	<b>3,6</b>	<b>4,0</b>
<b>MAX. LOAD kg</b>											
<b>65 S</b>		3170	3540	4090	4645	5015	5750	6090	6425	6760	<b>7100</b>
50 S		3790	4245	4920	5600	6055	6960	7370	7775	8180	8590
40 S		4280	4785	5545	6305	6810	7820	8280	8740	9200	9660
25 S		4900	5495	6395	7290	7885	9080	9615	10150	10685	11220
10 S		5800	6450	7430	8405	9055	10360	10965	11570	12175	12780

SIZE	Tread pattern	SW mm	OD mm	SLR mm	RC mm	SRI	Rim	Permitted Rims	Type	Tube	
<b>750/60R30.5</b> 181D	Twin Radial	790	1678	756	5130	800	AG24.00		TUBELESS		
<b>PRESSURE</b>											
psi		<b>14</b>	<b>17</b>	<b>22</b>	<b>26</b>	<b>29</b>	<b>35</b>	<b>41</b>	<b>46</b>	<b>52</b>	<b>58</b>
bar		<b>1,0</b>	<b>1,2</b>	<b>1,5</b>	<b>1,8</b>	<b>2,0</b>	<b>2,4</b>	<b>2,8</b>	<b>3,2</b>	<b>3,6</b>	<b>4,0</b>
<b>MAX. LOAD kg</b>											
<b>65 S</b>		3680	4110	4750	5395	5825	6680	7070	7465	7860	<b>8250</b>
50 S		4410	4935	5720	6505	7030	8080	8555	9030	9505	9980
40 S		4970	5560	6440	7325	7915	9090	9620	10155	10690	11220
25 S		5700	6395	7430	8470	9165	10550	11170	11795	12420	13040
10 S		6730	7490	8625	9765	10525	12040	12740	13445	14150	14850

SIZE	Tread pattern	SW mm	OD mm	SLR mm	RC mm	SRI	Rim	Permitted Rims	Type	Tube	
<b>850/50R30.5</b> 182D	Twin Radial	875	1630	735	4946	775	AG28.00		TUBELESS		
<b>PRESSURE</b>											
psi		<b>14</b>	<b>17</b>	<b>22</b>	<b>26</b>	<b>29</b>	<b>35</b>	<b>41</b>	<b>46</b>	<b>52</b>	<b>58</b>
bar		<b>1,0</b>	<b>1,2</b>	<b>1,5</b>	<b>1,8</b>	<b>2,0</b>	<b>2,4</b>	<b>2,8</b>	<b>3,2</b>	<b>3,6</b>	<b>4,0</b>
<b>MAX. LOAD kg</b>											
<b>65 S</b>		3400	3820	4450	5080	5500	6340	6880	7420	7960	<b>8500</b>
50 S		4110	4620	5380	6145	6655	7670	8325	8980	9635	10290
40 S		4620	5190	6050	6905	7475	8620	9355	10090	10825	11560
25 S		5370	6035	7025	8020	8685	10010	10865	11720	12575	13430
10 S		6430	7145	8210	9280	9995	11420	12390	13360	14330	15300

## TWIN RADIAL

Radial tire for transport equipment



SIZE	Tread pattern	SW mm	OD mm	SLR mm	RC mm	SRI	Rim	Permitted Rims	Type	Tube	
<b>800/60R32</b> 185D	<b>Twin Radial</b>	800	1805	810	5440	850	DW27B		TUBELESS		
<b>PRESSURE</b>											
<b>psi</b>		<b>14</b>	<b>17</b>	<b>22</b>	<b>26</b>	<b>29</b>	<b>35</b>	<b>41</b>	<b>46</b>	<b>52</b>	<b>58</b>
<b>bar</b>		<b>1,0</b>	<b>1,2</b>	<b>1,5</b>	<b>1,8</b>	<b>2,0</b>	<b>2,4</b>	<b>2,8</b>	<b>3,2</b>	<b>3,6</b>	<b>4,0</b>
<b>MAX. LOAD kg</b>											
<b>65 S</b>		3700	4165	4720	5275	5550	6385	7215	7680	8510	<b>9250</b>
50 S		4480	5040	5710	6380	6720	7725	8735	9290	10300	11195
40 S		5035	5665	6415	7175	7550	8685	9815	10445	11575	12580
25 S		5850	6580	7455	8335	8770	10085	11400	12135	13450	14615
10 S		6660	7495	8490	9495	9990	11490	12990	13820	15320	16650

For technical notes about pressure tables please refer to page 260.

## TWIN RADIAL





# T404



# T421



# T423



# T478



A complete range of low ground pressure tires, designed for field application with maximum respect for the soil, available in a variety of tread patterns and a wide range of sizes.

**TWIN 404** – The non-aggressive tread pattern makes this tire suitable for soft terrain. Characterized by its rounded shoulder design and a wide contact area.

**TWIN 421 and TWIN 423** – The unique bias-belt design maximizes the ground contact area, improving flotation and traction. The rounded shoulder ensures minimum soil compaction.

**TWIN 478** – The grooved tread pattern minimizes rolling resistance and it is ideal for road-work. The rounded shoulder enlarges the ground contact area.

## SIZE

280/60-15.5	115A8	T421
-------------	-------	------

280/60-15.5	125A8	T421
-------------	-------	------

280/60-15.5	128A8	T478
-------------	-------	------

400/45-15.5	116A8	T423
-------------	-------	------

400/60-15.5	145A8	T404
-------------	-------	------

400/60-15.5	148A8	T404
-------------	-------	------

400/60-15.5	145A8	T478
-------------	-------	------

420/55-17	133A8	T421
-----------	-------	------

420/55-17	145A8	T421
-----------	-------	------

400/55-17.5	131A8	T404
-------------	-------	------

400/55-22.5	147A8	T404
-------------	-------	------

500/45-22.5	146A8	T404
-------------	-------	------

500/60-22.5	155A8	T404
-------------	-------	------

500/60-22.5	155A8	T421
-------------	-------	------

560/45-22.5	154A8	T404
-------------	-------	------

560/60-22.5	167A8	T404
-------------	-------	------

600/50-22.5	156A8	T404
-------------	-------	------

600/50-22.5	156A8	T423
-------------	-------	------

## SIZE

600/50-22.5	165A8	T404
-------------	-------	------

600/50-22.5	168A8	T404
-------------	-------	------

710/40-22.5	158A8	T404
-------------	-------	------

400/60-26.5	147A8	T404
-------------	-------	------

600/55-26.5	166A8	T404
-------------	-------	------

600/55-26.5	166A8	T421
-------------	-------	------

600/55-26.5	173A8	T421
-------------	-------	------

710/45-26.5	169A8	T404
-------------	-------	------

710/45-26.5	169A8	T423 MK2
-------------	-------	----------

800/40-26.5	172A8	T404
-------------	-------	------

800/40-26.5	172A8	T423 MK2
-------------	-------	----------

650/65-30.5	173A8	T404
-------------	-------	------

710/50-30.5	175A8	T404
-------------	-------	------

710/50-30.5	175A8	T423
-------------	-------	------

750/60-30.5	178A8	T404
-------------	-------	------

800/45-30.5	178A8	T404
-------------	-------	------

800/45-30.5	178A8	T423
-------------	-------	------

850/50-30.5	179A8	T404
-------------	-------	------



SIZE	LI/SS	New tire		Tire in service		SLR mm +/- 2%	RC mm +/- 2.5%	Rim	Speed Km/h	PRESSURE	
		SW mm +/- 1.5%	OD mm +/- 1.5%	SW max mm	OD max mm					psi	bar
280/60-15.5 TL  T421	115A8 ⊕→	260	730	275	747	325	2142	AG8.00	Free Rolling		
									50		
									40		
									10		
	103A8 ⊕	260	730	275	747	325	2142	AG8.00	Driving wheel		
									50		
									40		
									25		
								10			
									10 C		

SIZE	LI/SS	New tire		Tire in service		SLR mm +/- 2%	RC mm +/- 2.5%	Rim	Speed Km/h	PRESSURE	
		SW mm +/- 1.5%	OD mm +/- 1.5%	SW max mm	OD max mm					psi	bar
280/60-15.5 TL  T421	125A8 ⊕→	272	736	278	747	331	2194	AG8.00	Free Rolling		
									50		
									40		
									10		
	113A8 ⊕	272	736	278	747	331	2194	AG8.00	Driving wheel		
									50		
									40		
									25		
								10			
									10 C		

SIZE	LI/SS	New tire		Tire in service		SLR mm +/- 2%	RC mm +/- 2.5%	Rim	Speed Km/h	PRESSURE	
		SW mm +/- 1.5%	OD mm +/- 1.5%	SW max mm	OD max mm					psi	bar
280/60-15.5 TT  T478	128A8 ⊕→	260	730	275	747	325	2142	AG8.00	Free Rolling		
									50		
									40		
									10		
									10 C		

SIZE	LI/SS	New tire		Tire in service		SLR mm +/- 2%	RC mm +/- 2.5%	Rim	Speed Km/h	PRESSURE	
		SW mm +/- 1.5%	OD mm +/- 1.5%	SW max mm	OD max mm					psi	bar
400/45-15.5 TL  T423	116A8 ⊕→	385	740	436	779	360	2172	AG13.00	Free Rolling		
									50		
									40		
									10		
	104A8 ⊕	385	740	436	779	360	2172	AG13.00	Driving wheel		
									50		
									40		
									25		
								10			
									10 C		

<b>7</b>	<b>12</b>	<b>14</b>	<b>17</b>	<b>20</b>	<b>23</b>	<b>26</b>	<b>29</b>	<b>32</b>	<b>35</b>	<b>38</b>	<b>41</b>	<b>43</b>	<b>46</b>	<b>49</b>	<b>51</b>	<b>52</b>	<b>54</b>	<b>55</b>	<b>58</b>	<b>59</b>	<b>67</b>	<b>72</b>	<b>75</b>	<b>84</b>		
<b>0,5</b>	<b>0,8</b>	<b>1,0</b>	<b>1,2</b>	<b>1,4</b>	<b>1,6</b>	<b>1,8</b>	<b>2,0</b>	<b>2,2</b>	<b>2,4</b>	<b>2,6</b>	<b>2,8</b>	<b>3,0</b>	<b>3,2</b>	<b>3,4</b>	<b>3,5</b>	<b>3,6</b>	<b>3,7</b>	<b>3,8</b>	<b>4,0</b>	<b>4,1</b>	<b>4,6</b>	<b>5,0</b>	<b>5,2</b>	<b>5,8</b>		
410	520	600	675	755	835	895	955	1025	1095																	
455	580	665	750	835	925	995	1060	1140	<b>1215</b>																	
600	750	855	955	1060	1165	1275	1365	1445	1530	1625	1720															
290	370	425	475	530	585	630	675	730	785																	
325	410	470	530	590	650	700	750	810	<b>875</b>																	
385	490	560	630	700	775	835	890	965	1040																	
425	535	605	675	750	820	895	960	1020	1090	1165	1240															
555	680	760	840	920	1005	1085	1165	1250	1325	1395	1470	1545	1630	1715	1760											

<b>7</b>	<b>12</b>	<b>14</b>	<b>17</b>	<b>20</b>	<b>23</b>	<b>26</b>	<b>29</b>	<b>32</b>	<b>35</b>	<b>38</b>	<b>41</b>	<b>43</b>	<b>46</b>	<b>49</b>	<b>52</b>	<b>55</b>	<b>58</b>	<b>59</b>	<b>62</b>	<b>67</b>	<b>70</b>	<b>72</b>	<b>75</b>	<b>84</b>		
<b>0,5</b>	<b>0,8</b>	<b>1,0</b>	<b>1,2</b>	<b>1,4</b>	<b>1,6</b>	<b>1,8</b>	<b>2,0</b>	<b>2,2</b>	<b>2,4</b>	<b>2,6</b>	<b>2,8</b>	<b>3,0</b>	<b>3,2</b>	<b>3,4</b>	<b>3,6</b>	<b>3,8</b>	<b>4,0</b>	<b>4,1</b>	<b>4,3</b>	<b>4,6</b>	<b>4,8</b>	<b>5,0</b>	<b>5,2</b>	<b>5,8</b>		
410	520	600	675	755	835	895	955	1025	1095	1175	1260	1305	1350	1420	1485											
455	580	665	750	835	925	995	1060	1140	1215	1305	1400	1450	1500	1575	<b>1650</b>											
600	750	855	955	1060	1165	1275	1365	1445	1530	1625	1720	1835	1950	2010	2085	2155	2245	2290								
290	370	425	475	530	585	630	675	730	785	845	900	930	955	995	1035											
325	410	470	530	590	650	700	750	810	875	935	1000	1030	1060	1105	<b>1150</b>											
385	490	560	630	700	775	835	890	965	1040	1115	1190	1230	1260	1315	1370											
425	535	605	675	750	820	895	960	1020	1090	1165	1240	1315	1395	1425	1475	1520	1570	1595								
555	680	760	840	920	1005	1085	1165	1250	1325	1395	1470	1545	1630	1715	1800	1885	1975	2015	2070	2105	2170	2225	2290			

<b>7</b>	<b>12</b>	<b>17</b>	<b>23</b>	<b>29</b>	<b>35</b>	<b>41</b>	<b>46</b>	<b>52</b>	<b>58</b>	<b>61</b>	<b>64</b>	<b>67</b>	<b>72</b>	<b>75</b>	<b>84</b>												
<b>0,5</b>	<b>0,8</b>	<b>1,2</b>	<b>1,6</b>	<b>2,0</b>	<b>2,4</b>	<b>2,8</b>	<b>3,2</b>	<b>3,6</b>	<b>4,0</b>	<b>4,2</b>	<b>4,4</b>	<b>4,6</b>	<b>5,0</b>	<b>5,2</b>	<b>5,8</b>												
410	520	675	835	955	1095	1260	1350	1485	1620																		
455	580	750	925	1060	1215	1400	1500	1650	<b>1800</b>																		
600	750	955	1165	1365	1530	1720	1950	2085	2245	2335	2430	2520															
660	800	995	1190	1390	1580	1745	1915	2105	2325	2420	2460	2500	2675	2765	3025												

<b>7</b>	<b>12</b>	<b>17</b>	<b>23</b>	<b>26</b>	<b>29</b>	<b>32</b>	<b>35</b>	<b>38</b>	<b>41</b>	<b>43</b>	<b>46</b>																		
<b>0,5</b>	<b>0,8</b>	<b>1,2</b>	<b>1,6</b>	<b>1,8</b>	<b>2,0</b>	<b>2,2</b>	<b>2,4</b>	<b>2,6</b>	<b>2,8</b>	<b>3,0</b>	<b>3,2</b>																		
565	720	925	1125																										
630	800	1030	<b>1250</b>																										
830	1035	1315	1590	1720																									
395	505	655	810																										
440	560	730	<b>900</b>																										
525	665	870	1070																										
580	725	925	1135	1240																									
755	920	1145	1375	1495	1610																								



SIZE	LI/SS	New tire		Tire in service		SLR mm +/-2%	RC mm +/-2,5%	Rim	Speed Km/h	PRESSURE		
		SW mm +/-1,5%	OD mm +/-1,5%	SW max mm	OD max mm					psi	bar	MAX. LOAD kg
400/60-15.5 TL T404	145A8 ⊕→	400	875	436	907	384	2568	AG13.00	Free Rolling			
										50		
									40			
									10			
	132A8 ⊕									Driving wheel		
											50	
										40		
										25		
								10				
								10 C				

SIZE	LI/SS	New tire		Tire in service		SLR mm +/-2%	RC mm +/-2,5%	Rim	Speed Km/h	PRESSURE		
		SW mm +/-1,5%	OD mm +/-1,5%	SW max mm	OD max mm					psi	bar	MAX. LOAD kg
400/60-15.5 TL T404	148A8 ⊕→	410	875	436	907	384	2568	AG13.00	Free Rolling			
										50		
									40			
									10			
	136A8 ⊕									Driving wheel		
											50	
										40		
										25		
								10				
								10 C				

SIZE	LI/SS	New tire		Tire in service		SLR mm +/-2%	RC mm +/-2,5%	Rim	Speed Km/h	PRESSURE	
		SW mm +/-1,5%	OD mm +/-1,5%	SW max mm	OD max mm					psi	bar
400/60-15.5 TL T478	145A8 ⊕→	400	875	436	907	384	2598	AG13.00	Free Rolling		
										50	
									40		
									10		

SIZE	LI/SS	New tire		Tire in service		SLR mm +/-2%	RC mm +/-2,5%	Rim	Speed Km/h	PRESSURE		
		SW mm +/-1,5%	OD mm +/-1,5%	SW max mm	OD max mm					psi	bar	MAX. LOAD kg
420/55-17 TL T421	133A8 ⊕→	415	898	420	912	397	2667	13.00	Free Rolling			
										50		
									40			
									10			
	121A8 ⊕						404		2685	Driving wheel		
											50	
										40		
										25		
								10				
								10 C				

7	12	17	23	26	29	32	35	38	41	43	46	49	52	55	58	59	67	72	75	84
0,5	0,8	1,2	1,6	1,8	2,0	2,2	2,4	2,6	2,8	3,0	3,2	3,4	3,6	3,8	4,0	4,1	4,6	5,0	5,2	5,8
730	925	1190	1440	1555	1665	1785	1910	2045	2185	2255	2320	2460	2610							
810	1030	1320	1600	1725	1850	1985	2120	2275	2430	2505	2575	2735	<b>2900</b>							
1065	1335	1690	2035	2205	2370	2515	2670	2835	3000	3195	3385	3465	3590	3720	3925	4025				
515	655	855	1010	1085	1155	1255	1350	1460	1575	1625	1665	1760	1855							
575	730	950	1120	1205	1285	1390	1500	1625	1750	1805	1850	1955	<b>2060</b>							
685	870	1130	1335	1435	1530	1655	1785	1930	2085	2145	2200	2325	2450							
755	945	1205	1445	1545	1655	1750	1865	1995	2125	2280	2440	2495	2580	2665	2795	2860				
985	1200	1490	1795	1945	2050	2175	2280	2400	2520	2645	2790	2935	3105	3270	3460	3530	3675	3965	4105	

7	12	17	23	26	29	32	35	38	41	43	46	49	52	55	58	61	64	67	72	75	78	81	84
0,5	0,8	1,2	1,6	1,8	2,0	2,2	2,4	2,6	2,8	3,0	3,2	3,4	3,6	3,8	4,0	4,2	4,4	4,6	5,0	5,2	5,4	5,6	5,8
730	925	1190	1440	1555	1665	1785	1910	2045	2185	2255	2320	2460	2610	2725	2835								
810	1030	1320	1600	1725	1850	1985	2120	2275	2430	2505	2575	2735	2900	3025	<b>3150</b>								
1065	1335	1690	2035	2205	2370	2515	2670	2835	3000	3195	3385	3465	3590	3720	3925	4100	4260	4410					
515	655	855	1010	1085	1155	1255	1350	1460	1575	1625	1665	1760	1855	1935	2015								
575	730	950	1120	1205	1285	1390	1500	1625	1750	1805	1850	1955	2060	2150	<b>2240</b>								
685	870	1130	1335	1435	1530	1655	1785	1930	2085	2145	2200	2325	2450	2560	2665								
755	945	1205	1445	1545	1655	1750	1865	1995	2125	2280	2440	2495	2580	2665	2795	2860	3030	3135					
985	1200	1490	1795	1945	2050	2175	2280	2400	2520	2645	2790	2935	3105	3270	3460	3530	3640	3675	3965	4105	4235	4355	4480

7	12	14	17	20	23	26	29	32	33	35	38	41	42	43	46	49	51	52	54	55	58	59	67	72	75
0,5	0,8	1,0	1,2	1,4	1,6	1,8	2,0	2,2	2,3	2,4	2,6	2,8	2,9	3,0	3,2	3,4	3,5	3,6	3,7	3,8	4,0	4,1	4,6	5,0	5,2
730	925	1190	1440	1555	1665	1785	1910	2045	2185	2255	2320	2460	2610												
810	1030	1320	1600	1725	1850	1985	2120	2275	2430	2505	2575	2735	<b>2900</b>												
1065	1335	1690	2035	2205	2370	2515	2670	2835	3000	3195	3385	3465	3590	3720	3925	4025									
1170	1425	1765	2100	2270	2430	2590	2740	2890	3040	3185	3345	3500	3670	3845	4035	4115	4295	4675	4855						

7	12	14	17	20	23	26	29	32	33	35	38	41	42	43	46	49	51	52	54	55	58	59	67	72	75	84
0,5	0,8	1,0	1,2	1,4	1,6	1,8	2,0	2,2	2,3	2,4	2,6	2,8	2,9	3,0	3,2	3,4	3,5	3,6	3,7	3,8	4,0	4,1	4,6	5,0	5,2	5,8
815	1035	1170	1305	1460	1620	1740	1855																			
905	1150	1300	1450	1625	1800	1935	<b>2060</b>																			
1190	1490	1680	1860	2050	2265	2480	2660	2810	2885																	
585	740	835	925	1025	1125	1215	1305																			
650	825	930	1030	1140	1250	1350	<b>1450</b>																			
770	980	1105	1225	1355	1485	1610	1725																			
855	1070	1205	1335	1455	1590	1720	1850	1970	2030																	
1115	1355	1520	1680	1820	1965	2105	2255	2410	2485	2550	2695	2835	2900													

### Twin Implement - T404 - T421 - T423 - T478

X-ply tires for transport equipment



SIZE	LI/SS	New tire		Tire in service		SLR mm +/- 2%	RC mm +/- 2,5%	Rim	Speed Km/h	PRESSURE	
		SW mm +/- 1,5%	OD mm +/- 1,5%	SW max mm	OD max mm					psi	bar
420/55-17 TL  T421	145A8 ⊕→	415	898	420	912	400	2670	13.00	Free Rolling		
									50		
									40		
									10		
	133A8 ⊕	415	898	420	912	400	2670	13.00	Driving wheel		
									50		
									40		
									25		
								10			
								10 C			

SIZE	LI/SS	New tire		Tire in service		SLR mm +/- 2%	RC mm +/- 2,5%	Rim	Speed Km/h	PRESSURE	
		SW mm +/- 1,5%	OD mm +/- 1,5%	SW max mm	OD max mm					psi	bar
400/55-17.5 TT  T404	131A8 ⊕→	400	880	420	902	388	2583	AG11.75	Free Rolling		
									50		
									40		
									10		
	119A8 ⊕	400	880	420	902	400	2609	AG11.75	Driving wheel		
									50		
									40		
									25		
								10			
								10 C			

SIZE	LI/SS	New tire		Tire in service		SLR mm +/- 2%	RC mm +/- 2,5%	Rim	Speed Km/h	PRESSURE	
		SW mm +/- 1,5%	OD mm +/- 1,5%	SW max mm	OD max mm					psi	bar
400/55-22.5 TL  T404	147A8 ⊕→	400	1000	420	1021	450	3035	AG11.75	Free Rolling		
									50		
									40		
									10		
	135A8 ⊕	400	1000	420	1021	460	3045	AG11.75	Driving wheel		
									50		
									40		
									25		
								10			
								10 C			

SIZE	LI/SS	New tire		Tire in service		SLR mm +/- 1,5%	RC mm +/- 2,5%	Rim	Speed Km/h	PRESSURE	
		SW mm +/- 1,5%	OD mm +/- 1,5%	SW max mm	OD max mm					psi	bar
500/45-22.5 TL  T404	146A8 ⊕→	500	1020	528	1042	450	3020	AG16.00	Free Rolling		
									50		
									40		
									10		
	134A8 ⊕	500	1020	528	1042	465	3050	AG16.00	Driving wheel		
									50		
									40		
									25		
								10			
								10 C			



SIZE	LI/SS	New tire		Tire in service		SLR mm +/- 2%	RC mm +/- 2,5%	Rim	Speed Km/h	PRESSURE	
		SW mm +/- 1,5%	OD mm +/- 1,5%	SW max mm	OD max mm					psi	bar
500/60-22.5 TL T404	155A8 ⊕→	500	1170	528	1200	500	3490	AG16.00	Free Rolling		
									50		
									40		
									10		
	143A8 ⊕	500	1170	528	1200	530	3510	AG16.00	Driving wheel		
									50		
									40		
									25		
								10			
									10 C		

SIZE	LI/SS	New tire		Tire in service		SLR mm +/- 2%	RC mm +/- 2,5%	Rim	Speed Km/h	PRESSURE	
		SW mm +/- 1,5%	OD mm +/- 1,5%	SW max mm	OD max mm					psi	bar
500/60-22.5 TL T421	155A8 ⊕→	500	1170	528	1200	525	3490	AG16.00	Free Rolling		
									50		
									40		
									10		
	143A8 ⊕	500	1170	528	1200	545	3510	AG16.00	Driving wheel		
									50		
									40		
									25		
								10			
									10 C		

SIZE	LI/SS	New tire		Tire in service		SLR mm +/- 2%	RC mm +/- 2,5%	Rim	Speed Km/h	PRESSURE	
		SW mm +/- 1,5%	OD mm +/- 1,5%	SW max mm	OD max mm					psi	bar
560/45-22.5 TL T404	154A8 ⊕→	540	1075	609	1111	475	3235	AG16.00	Free Rolling		
									50		
									40		
									10		
	142A8 ⊕	540	1075	609	1111	490	3245	AG16.00	Driving wheel		
									50		
									40		
									25		
								10			
									10 C		

SIZE	LI/SS	New tire		Tire in service		SLR mm +/- 1,5%	RC mm +/- 2,5%	Rim	Speed Km/h	PRESSURE	
		SW mm +/- 1,5%	OD mm +/- 1,5%	SW max mm	OD max mm					psi	bar
560/60-22.5 TL T404	167A8 ⊕→	564	1235	609	1291	525	3675	AG16.00	Free Rolling		
									50		
									40		
									10		
	155A8 ⊕	564	1235	609	1291	541	3685	AG16.00	Driving wheel		
									50		
									40		
									25		
								10			
									10 C		



7	12	14	17	20	23	26	29	32	35	38	41	43	46	49	51	52	54	55	58	59	67	72	75	84
0,5	0,8	1,0	1,2	1,4	1,6	1,8	2,0	2,2	2,4	2,6	2,8	3,0	3,2	3,4	3,5	3,6	3,7	3,8	4,0	4,1	4,6	5,0	5,2	5,8

1310 1665 1895 2125 2365 2610 2815 3015 3250 3490  
 1455 1850 2105 2360 2630 2900 3130 3350 3610 **3875**  
 1915 2395 2715 3025 3335 3665 3995 4290 4560 4850 5170 5490

910 1155 1340 1530 1695 1855 1990 2125 2290 2450  
 1010 1285 1490 1700 1880 2060 2215 2360 2540 **2725**  
 1200 1530 1775 2025 2240 2450 2635 2810 3025 3245  
 1330 1665 1900 2145 2405 2620 2840 3045 3220 3415 3635 3860  
 1735 2115 2370 2620 2915 3195 3480 3725 3975 4190 4415 4630 4845 5095 5350 5475

7	12	14	17	20	23	26	29	32	35	38	41	43	46	49	51	52	54	55	58	59	67	72	75	84
0,5	0,8	1,0	1,2	1,4	1,6	1,8	2,0	2,2	2,4	2,6	2,8	3,0	3,2	3,4	3,5	3,6	3,7	3,8	4,0	4,1	4,6	5,0	5,2	5,8

1310 1665 1895 2125 2365 2610 2815 3015 3250 3490  
 1455 1850 2105 2360 2630 2900 3130 3350 3610 **3875**  
 1915 2395 2715 3025 3335 3665 3995 4290 4560 4850 5170 5490

910 1155 1340 1530 1695 1855 1990 2125 2290 2450  
 1010 1285 1490 1700 1880 2060 2215 2360 2540 **2725**  
 1200 1530 1775 2025 2240 2450 2635 2810 3025 3245  
 1330 1665 1900 2145 2405 2620 2840 3045 3220 3415 3635 3860  
 1735 2115 2370 2620 2915 3195 3480 3715 3975 4190 4415 4630 4845 5095 5350 5475

7	12	14	17	20	23	26	29	32	35	38	41	43	46	49	51	52	54	55	58	59	67	72	75	84
0,5	0,8	1,0	1,2	1,4	1,6	1,8	2,0	2,2	2,4	2,6	2,8	3,0	3,2	3,4	3,5	3,6	3,7	3,8	4,0	4,1	4,6	5,0	5,2	5,8

1275 1620 1845 2070 2295 2520 2725 2925 3150 3375  
 1415 1800 2050 2300 2550 2800 3025 3250 3500 **3750**  
 1860 2330 2640 2945 3250 3555 3855 4150 4420 4700 5005 5310

885 1125 1305 1485 1645 1800 1935 2070 2225 2385  
 980 1250 1445 1650 1825 2000 2150 2300 2475 **2650**  
 1170 1485 1720 1965 2170 2380 2560 2735 2945 3155  
 1295 1620 1850 2080 2330 2545 2755 2955 3135 3325 3540 3755  
 1685 2055 2305 2550 2835 3100 3375 3615 3855 4070 4290 4510 4720 4960 5205 5325

7	12	14	17	20	23	26	29	32	35	38	41	43	46	49	52	55	58	59	67	72	75	84
0,5	0,8	1,0	1,2	1,4	1,6	1,8	2,0	2,2	2,4	2,6	2,8	3,0	3,2	3,4	3,6	3,8	4,0	4,1	4,6	5,0	5,2	5,8

1625 2070 2380 2700 2995 3285 3555 3825 4105 4390 4650 4905  
 1805 2300 2645 3000 3325 3650 3950 4250 4565 4875 5165 **5450**  
 2380 2980 3390 3820 4240 4635 5030 5415 5770 6140 6330 6905 7250 7590

1165 1485 1695 1910 2115 2320 2510 2700 2905 3105 3295 3485  
 1295 1650 1885 2120 2350 2575 2790 3000 3225 3450 3665 **3875**  
 1545 1965 2245 2525 2795 3065 3320 3570 3840 4105 4360 4610  
 1705 2140 2425 2710 2995 3275 3550 3820 4075 4335 4610 4885 5140 5395  
 2225 2715 3040 3365 3690 4015 4335 4650 4965 5260 5560 5860 6155 6465 6780 7075 7375 7655 7810

## Twin Implement - T404 - T421 - T423 - T478

X-ply tires for transport equipment



SIZE	LI/SS	New tire		Tire in service		SLR mm +/- 2%	RC mm +/- 2.5%	Rim	Speed Km/h	PRESSURE	
		SW mm +/- 1.5%	OD mm +/- 1.5%	SW max mm	OD max mm					psi	bar
600/50-22.5 TL T404	156A8 ⊕→	610	1170	638	1214	520	3460	AG20.00	Free Rolling	50	
										40	
										10	
										Driving wheel	
	144A8 ⊕	540	3500	50							
				40							
				25							
				10							
									10 C		

SIZE	LI/SS	New tire		Tire in service		SLR mm +/- 2%	RC mm +/- 2.5%	Rim	Speed Km/h	PRESSURE	
		SW mm +/- 1.5%	OD mm +/- 1.5%	SW max mm	OD max mm					psi	bar
600/50-22.5 TL T423	156A8 ⊕→	600	1170	630	1214	520	3460	AG20.00	Free Rolling	50	
										40	
										10	
										Driving wheel	
	144A8 ⊕	540	3500	50							
				40							
				25							
				10							
									10 C		

SIZE	LI/SS	New tire		Tire in service		SLR mm +/- 2%	RC mm +/- 2.5%	Rim	Speed Km/h	PRESSURE	
		SW mm +/- 1.5%	OD mm +/- 1.5%	SW max mm	OD max mm					psi	bar
600/50-22.5 TL T404	165A8 ⊕→	610	1170	638	1214	510	3470	AG20.00	Free Rolling	50	
										40	
										10	
										Driving wheel	
	153A8 ⊕	530	3510	50							
				40							
				25							
				10							
									10 C		

SIZE	LI/SS	New tire		Tire in service		SLR mm +/- 1.5%	RC mm +/- 2.5%	Rim	Speed Km/h	PRESSURE	
		SW mm +/- 1.5%	OD mm +/- 1.5%	SW max mm	OD max mm					psi	bar
600/50-22.5 TL T404	168A8 ⊕→	610	1170	638	1214	500	3480	AG20.00	Free Rolling	50	
										40	
										10	
										Driving wheel	
	156A8 ⊕	520	3520	50							
				40							
				25							
				10							
									10 C		

7	12	14	17	20	23	26	29	32	33	35	38	41	42	43	46	49	52	54	58	61	64	67	72	75	84
0,5	0,8	1,0	1,2	1,4	1,6	1,8	2,0	2,2	2,3	2,4	2,6	2,8	2,9	3,0	3,2	3,4	3,6	3,7	4,0	4,2	4,4	4,6	5,0	5,2	5,8
1540	1960	2240	2520	2810	3105	3355	3600																		
1715	2180	2490	2800	3125	3450	3730	<b>4000</b>																		
2255	2825	3200	3580	3955	4355	4755	5110	5440	5600																
1095	1395	1595	1800	1995	2185	2355	2520																		
1220	1550	1775	2000	2215	2430	2620	<b>2800</b>																		
1450	1845	2110	2380	2635	2890	3115	3330																		
1605	2010	2280	2550	2825	3090	3350	3595	3815	3920																
2090	2550	2855	3160	3470	3780	4090	4385	4685	4830	4950	5220	5485	5600												

7	12	14	17	20	23	26	29	32	33	35	38	41	42	43	46	49	52	54	58	61	64	67	72	75	84
0,5	0,8	1,0	1,2	1,4	1,6	1,8	2,0	2,2	2,3	2,4	2,6	2,8	2,9	3,0	3,2	3,4	3,6	3,7	4,0	4,2	4,4	4,6	5,0	5,2	5,8
1540	1960	2240	2520	2810	3105	3355	3600																		
1715	2180	2490	2800	3125	3450	3730	<b>4000</b>																		
2255	2825	3200	3580	3955	4355	4755	5110	5440	5600																
1095	1395	1595	1800	1995	2185	2355	2520																		
1220	1550	1775	2000	2215	2430	2620	<b>2800</b>																		
1450	1845	2110	2380	2635	2890	3115	3330																		
1605	2010	2280	2550	2825	3090	3350	3595	3815	3920																
2090	2550	2855	3160	3470	3780	4090	4385	4685	4830	4950	5220	5485	5600												

7	12	14	17	20	23	26	29	32	35	38	41	43	46	49	52	55	58	59
0,5	0,8	1,0	1,2	1,4	1,6	1,8	2,0	2,2	2,4	2,6	2,8	3,0	3,2	3,4	3,6	3,8	4,0	4,1
1540	1960	2240	2520	2810	3105	3355	3600	3880	4165	4400	4635							
1715	2180	2490	2800	3125	3450	3730	4000	4310	4625	4890	<b>5150</b>							
2255	2825	3200	3580	3955	4355	4755	5110	5440	5790	6170	6550	6865	7175					
1095	1395	1595	1800	1995	2185	2355	2520	2720	2925	3105	3285							
1220	1550	1775	2000	2215	2430	2620	2800	3025	3250	3450	<b>3650</b>							
1450	1845	2110	2380	2635	2890	3115	3330	3600	3865	4105	4345							
1605	2010	2280	2550	2825	3090	3350	3595	3815	4055	4335	4605	4845	5085					
2090	2550	2855	3160	3470	3780	4090	4385	4685	4950	5220	5485	5755	6065	6370	6665	6945	7210	7360

7	12	14	17	20	23	26	29	32	35	38	41	43	46	49	52	58	61	64	67
0,5	0,8	1,0	1,2	1,4	1,6	1,8	2,0	2,2	2,4	2,6	2,8	3,0	3,2	3,4	3,6	4,0	4,2	4,4	4,6
1540	1960	2240	2520	2810	3105	3355	3600	3880	4165	4400	4635	4840	5040						
1715	2180	2490	2800	3125	3450	3730	4000	4310	4625	4890	5150	5380	<b>5600</b>						
2255	2825	3200	3580	3955	4355	4755	5110	5440	5790	6170	6550	6865	7175	7440	7875				
1095	1395	1595	1800	1995	2185	2355	2520	2720	2925	3105	3285	3445	3600						
1220	1550	1775	2000	2215	2430	2620	2800	3025	3250	3450	3650	3825	<b>4000</b>						
1450	1845	2110	2380	2635	2890	3115	3330	3600	3865	4105	4345	4555	4760						
1605	2010	2280	2550	2825	3090	3350	3595	3815	4055	4335	4605	4845	5085	5295	5625				
2090	2550	2855	3160	3470	3780	4090	4385	4685	4950	5220	5485	5755	6065	6370	6800	7210	751		

## Twin Implement - T404 - T421 - T423 - T478

X-ply tires for transport equipment



SIZE	LI/SS	New tire		Tire in service		SLR mm +/- 2%	RC mm +/- 2,5%	Rim	Speed Km/h	PRESSURE	
		SW mm +/- 1,5%	OD mm +/- 1,5%	SW max mm	OD max mm					psi	bar
710/40-22.5 TL  T404	158A8 ⊕→	710	1160	773	1179	510	3460	AG24.00x22.5"	Free Rolling		
									50		
									40		
									10		
	146A8 ⊕	525	3470	Driving wheel							
				50							
				40							
				25							
			10								
			10 C								

SIZE	LI/SS	New tire		Tire in service		SLR mm +/- 2%	RC mm +/- 2,5%	Rim	Speed Km/h	PRESSURE	
		SW mm +/- 1,5%	OD mm +/- 1,5%	SW max mm	OD max mm					psi	bar
400/60-26.5 TT  T404	147A8 ⊕→	400	1160	425	1187	525	3470	AG13.00	Free Rolling		
									50		
									40		
									10		
	135A8 ⊕	540	3490	Driving wheel							
				50							
				40							
				25							
			10								
			10 C								

SIZE	LI/SS	New tire		Tire in service		SLR mm +/- 2%	RC mm +/- 2,5%	Rim	Speed Km/h	PRESSURE	
		SW mm +/- 1,5%	OD mm +/- 1,5%	SW max mm	OD max mm					psi	bar
600/55-26.5 TL  T404	166A8 ⊕→	620	1360	638	1379	595	3970	AG20.00	Free Rolling		
									50		
									40		
									10		
	154A8 ⊕	619	4000	Driving wheel							
				50							
				40							
				25							
			10								
			10 C								

SIZE	LI/SS	New tire		Tire in service		SLR mm +/- 2%	RC mm +/- 2,5%	Rim	Speed Km/h	PRESSURE	
		SW mm +/- 1,5%	OD mm +/- 1,5%	SW max mm	OD max mm					psi	bar
600/55-26.5 TL  T421	166A8 ⊕→	600	1350	638	1379	595	3970	AG20.00	Free Rolling		
									50		
									40		
									10		
	154A8 ⊕	619	4000	Driving wheel							
				50							
				40							
				25							
			10								
			10 C								

7	12	14	17	20	23	26	29	32	33	35	38	41	42	43	46	49	52	54	58	61	64	67	72	75	84		
0,5	0,8	1,0	1,2	1,4	1,6	1,8	2,0	2,2	2,3	2,4	2,6	2,8	2,9	3,0	3,2	3,4	3,6	3,7	4,0	4,2	4,4	4,6	5,0	5,2	5,8		
1625	2070	2385	2700	2995	3285	3555	3825																				
1810	2300	2650	3000	3325	3650	3950	<b>4250</b>																				
2380	2980	3395	3820	4240	4635	5030	5415	5775	5950																		
1165	1485	1695	1910	2115	2315	2510	2700																				
1295	1650	1885	2120	2350	2575	2790	<b>3000</b>																				
1545	1965	2245	2525	2795	3065	3320	3570																				
1710	2140	2425	2710	2995	3275	3550	3820	4075	4200																		
2230	2715	3040	3365	3690	4015	4340	4650	4965	5120	5260	5560	5860	6000														

7	12	14	17	20	23	26	29	32	35	38	41	43	46	49	51	52	54	58	61	64	67	72	75	84			
0,5	0,8	1,0	1,2	1,4	1,6	1,8	2,0	2,2	2,4	2,6	2,8	3,0	3,2	3,4	3,5	3,6	3,7	4,0	4,2	4,4	4,6	5,0	5,2	5,8			
1060	1350	1530	1710	1890	2070	2260	2455	2615	2770																		
1180	1500	1700	1900	2100	2300	2510	2725	2905	<b>3075</b>																		
1555	1945	2195	2440	2685	2930	3170	3425	3685	3920	4130	4355																
750	955	1075	1190	1335	1485	1620	1755	1860	1960																		
835	1060	1195	1320	1485	1650	1800	1950	2065	<b>2180</b>																		
990	1260	1420	1570	1765	1965	2140	2320	2460	2595																		
1095	1375	1545	1715	1865	2070	2275	2455	2640	2800	2935	3085																
1430	1745	1955	2160	2335	2520	2700	2935	3160	3385	3590	3795	3975	4145	4315	4380												

7	12	14	17	20	23	26	29	32	35	38	41	43	46	49	51	52	54	58	61	64	67	72	75	84			
0,5	0,8	1,0	1,2	1,4	1,6	1,8	2,0	2,2	2,4	2,6	2,8	3,0	3,2	3,4	3,5	3,6	3,7	4,0	4,2	4,4	4,6	5,0	5,2	5,8			
1820	2320	2625	2925	3260	3600	3885	4165	4470	4770																		
2025	2575	2915	3250	3625	4000	4315	4625	4965	<b>5300</b>																		
2665	3335	3765	4175	4595	5050	5510	5920	6295	6680	7090	7505																
1310	1665	1870	2070	2295	2520	2725	2925	3150	3375																		
1455	1850	2080	2300	2550	2800	3025	3250	3500	<b>3750</b>																		
1730	2200	2475	2735	3035	3330	3605	3870	4165	4460																		
1915	2395	2695	2990	3250	3555	3860	4150	4420	4700	5005	5310																
2495	3045	3410	3770	4070	4390	4705	5050	5395	5715	6035	6355	6675	7015	7360	7535												

7	12	14	17	20	23	26	29	32	35	38	41	43	46	49	51	52	54	58	61	64	67	72	75	84			
0,5	0,8	1,0	1,2	1,4	1,6	1,8	2,0	2,2	2,4	2,6	2,8	3,0	3,2	3,4	3,5	3,6	3,7	4,0	4,2	4,4	4,6	5,0	5,2	5,8			
1820	2320	2625	2925	3260	3600	3885	4165	4470	4770																		
2025	2575	2915	3250	3625	4000	4315	4625	4965	<b>5300</b>																		
2665	3335	3765	4175	4595	5050	5510	5920	6295	6680	7090	7505																
1310	1665	1870	2070	2295	2520	2725	2925	3150	3375																		
1455	1850	2080	2300	2550	2800	3025	3250	3500	<b>3750</b>																		
1730	2200	2475	2735	3035	3330	3605	3870	4165	4460																		
1915	2395	2695	2990	3250	3555	3860	4150	4420	4700	5005	5310																
2495	3045	3410	3770	4070	4390	4705	5050	5395	5715	6035	6355	6675	7015	7360	7535												

## Twin Implement - T404 - T421 - T423 - T478

X-ply tires for transport equipment



SIZE	LI/SS	New tire		Tire in service		SLR mm +/- 2%	RC mm +/- 2,5%	Rim	Speed Km/h	PRESSURE	
		SW mm +/- 1,5%	OD mm +/- 1,5%	SW max mm	OD max mm					psi	bar
600/55-26.5  T421	173A8 ⊕→	610	1350	638	1379	600	3980	AG20.00	Free Rolling		
									50		
									40		
									10		
									10		
	161A8 ⊕	625	4010	Driving wheel							
				50							
				40							
				25							
				10							
10 C											

SIZE	LI/SS	New tire		Tire in service		SLR mm +/- 2%	RC mm +/- 2,5%	Rim	Speed Km/h	PRESSURE	
		SW mm +/- 1,5%	OD mm +/- 1,5%	SW max mm	OD max mm					psi	bar
710/45-26.5 TL  T404	169A8 ⊕→	710	1350	773	1384	600	3980	AG24.00	Free Rolling		
									50		
									40		
									10		
									10		
	157A8 ⊕	620	4000	Driving wheel							
				50							
				40							
				25							
				10							
10 C											

SIZE	LI/SS	New tire		Tire in service		SLR mm +/- 2%	RC mm +/- 2,5%	Rim	Speed Km/h	PRESSURE	
		SW mm +/- 1,5%	OD mm +/- 1,5%	SW max mm	OD max mm					psi	bar
710/45-26.5 TL  T423 MK2	169A8 ⊕→	710	1350	773	1384	590	3970	AG24.00	Free Rolling		
									50		
									40		
									10		
									10		
	157A8 ⊕	610	4020	Driving wheel							
				50							
				40							
				25							
				10							
10 C											

SIZE	LI/SS	New tire		Tire in service		SLR mm +/- 1,5%	RC mm +/- 2,5%	Rim	Speed Km/h	PRESSURE	
		SW mm +/- 1,5%	OD mm +/- 1,5%	SW max mm	OD max mm					psi	bar
800/40-26.5 TL  T404	172A8 ⊕→	800	1350	840	1379	590	3970	AG28.00	Free Rolling		
									50		
									40		
									10		
									10		
	159A8 ⊕	610	4020	Driving wheel							
				50							
				40							
				25							
				10							
10 C											

7	11	14	17	20	23	26	29	32	35	38	41	43	46	49	51	52	54	58	61	64	67
0.5	0.8	1.0	1.2	1.4	1.6	1.8	2.0	2.2	2.4	2.6	2.8	3.0	3.2	3.4	3.5	3.6	3.7	4.0	4.2	4.4	4.6
1820	2320	2625	2925	3260	3600	3885	4165	4470	4770	5150	5535	5700	5850								
2025	2575	2915	3250	3625	4000	4315	4625	4965	5300	5720	6150	6335	<b>6500</b>								
2665	3335	3765	4175	4595	5050	5510	5920	6295	6680	7090	7505	8030	8565	8760	8975	9060	9140				
1310	1665	1870	2070	2295	2520	2725	2925	3150	3375	3655	3935	4055	4160								
1455	1850	2080	2300	2550	2800	3025	3250	3500	3750	4060	4375	4505	<b>4625</b>								
1730	2200	2475	2735	3035	3330	3605	3870	4165	4460	4830	5205	5365	5505								
1915	2395	2695	2990	3250	3555	3860	4150	4420	4700	5005	5310	5700	6095	6235	6385	6445	6505				
2495	3045	3410	3770	4070	4390	4705	5050	5395	5715	6035	6355	6675	7015	7360	7535	7765	7995	8645	9000	9100	9180

7	12	14	17	20	23	26	29	32	35	38	41	43	46	49	51	52	54	58	61	64	67	72	75	84
0.5	0.8	1.0	1.2	1.4	1.6	1.8	2.0	2.2	2.4	2.6	2.8	3.0	3.2	3.4	3.5	3.6	3.7	4.0	4.2	4.4	4.6	5.0	5.2	5.8
1980	2520	2860	3195	3565	3940	4225	4500	4860	5220															
2200	2800	3175	3550	3960	4375	4695	5000	5400	<b>5800</b>															
2895	3625	4100	4555	5015	5520	6030	6460	6825	7245	7735	8215													
1415	1800	2030	2250	2510	2770	2985	3195	3455	3715															
1570	2000	2255	2500	2785	3075	3315	3550	3835	<b>4125</b>															
1870	2380	2680	2975	3315	3660	3945	4225	4565	4910															
2070	2590	2920	3240	3535	3885	4235	4550	4830	5145	5500	5840													
2700	3290	3685	4080	4410	4765	5115	5515	5910	6270	6615	6955	7300	7690	8085	8290									

7	12	14	17	20	23	26	29	32	35	38	41	43	46	49	51	52	54	58	61	64	67	72	75	84
0.5	0.8	1.0	1.2	1.4	1.6	1.8	2.0	2.2	2.4	2.6	2.8	3.0	3.2	3.4	3.5	3.6	3.7	4.0	4.2	4.4	4.6	5.0	5.2	5.8
1980	2520	2860	3195	3565	3940	4225	4500	4860	5220															
2200	2800	3175	3550	3960	4375	4695	5000	5400	<b>5800</b>															
2895	3625	4100	4555	5015	5520	6030	6460	6825	7245	7735	8215													
1415	1800	2030	2250	2510	2770	2985	3195	3455	3715															
1570	2000	2255	2500	2785	3075	3315	3550	3835	<b>4125</b>															
1870	2380	2680	2975	3315	3660	3945	4225	4565	4910															
2070	2590	2920	3240	3535	3885	4235	4550	4830	5145	5500	5840													
2700	3290	3685	4080	4410	4765	5115	5515	5910	6270	6615	6955	7300	7690	8085	8290									

7	12	14	17	20	23	26	29	32	35	38	41	43	46	49	51	52	54	58	61	64	67	72	75	84
0.5	0.8	1.0	1.2	1.4	1.6	1.8	2.0	2.2	2.4	2.6	2.8	3.0	3.2	3.4	3.5	3.6	3.7	4.0	4.2	4.4	4.6	5.0	5.2	5.8
2120	2700	3090	3490	3880	4275	4595	4905	5285	5670															
2355	3000	3435	3875	4310	4750	5105	5450	5875	<b>6300</b>															
3105	3885	4415	4945	5475	6010	6545	7020	7430	7890	8405	8925													
1500	1910	2180	2450	2735	3015	3255	3485	3715	3940															
1665	2120	2420	2725	3035	3350	3615	3875	4130	<b>4375</b>															
1980	2525	2885	3245	3615	3985	4300	4610	4910	5205															
2195	2745	3115	3485	3850	4230	4615	4960	5270	5575	5875	6195													
2860	3490	3905	4325	4740	5160	5575	6010	6440	6830	7210	7585	7910	8275	8635	8790									

## Twin Implement - T404 - T421 - T423 - T478

X-ply tires for transport equipment



SIZE	LI/SS	New tire		Tire in service		SLR mm +/- 2%	RC mm +/- 2,5%	Rim	Speed Km/h	PRESSURE	
		SW mm +/- 1,5%	OD mm +/- 1,5%	SW max mm	OD max mm					psi	bar
800/40-26.5 TL T423 MK2	172A8 ⊕→	800	1350	840	1379	600	3970	AG28.00	Free Rolling		
									50		
									40		
									10		
	159A8 ⊕	620	4020	Driving wheel							
				50							
				40							
				25							
			10								
			10 C								

SIZE	LI/SS	New tire		Tire in service		SLR mm +/- 2%	RC mm +/- 2,5%	Rim	Speed Km/h	PRESSURE	
		SW mm +/- 1,5%	OD mm +/- 1,5%	SW max mm	OD max mm					psi	bar
650/65-30.5 TL T404	173A8 ⊕→	660	1650	697	1679	710	4830	AG20.00	Free Rolling		
									50		
									40		
									10		
	160A8 ⊕	740	4860	Driving wheel							
				50							
				40							
				25							
			10								
			10 C								

SIZE	LI/SS	New tire		Tire in service		SLR mm +/- 2%	RC mm +/- 2,5%	Rim	Speed Km/h	PRESSURE	
		SW mm +/- 1,5%	OD mm +/- 1,5%	SW max mm	OD max mm					psi	bar
710/50-30.5 TL T404	175A8 ⊕→	727	1500	773	1534	650	4425	AG24.00	Free Rolling		
									50		
									40		
									10		
	163A8 ⊕	680	4455	Driving wheel							
				50							
				40							
				25							
			10								
			10 C								

SIZE	LI/SS	New tire		Tire in service		SLR mm +/- 2%	RC mm +/- 2,5%	Rim	Speed Km/h	PRESSURE	
		SW mm +/- 1,5%	OD mm +/- 1,5%	SW max mm	OD max mm					psi	bar
710/50-30.5 TL T423	175A8 ⊕→	730	1500	773	1534	660	4425	AG24.00	Free Rolling		
									50		
									40		
									10		
	163A8 ⊕	690	4455	Driving wheel							
				50							
				40							
				25							
			10								
			10 C								



7 12 14 17 20 23 26 29 32 35 38 41 43 46 49 51 52 54 58 61 64 67 72 75 84  
0,5 0,8 1,0 1,2 1,4 1,6 1,8 2,0 2,2 2,4 2,6 2,8 3,0 3,2 3,4 3,5 3,6 3,7 4,0 4,2 4,4 4,6 5,0 5,2 5,8

2120 2700 3090 3490 3880 4275 4595 4905 5285 5670  
2355 3000 3435 3875 4310 4750 5105 5450 5875 **6300**  
3105 3885 4415 4945 5475 6010 6545 7020 7430 7890 8405 8925  
1500 1910 2180 2450 2735 3015 3255 3485 3715 3940  
1665 2120 2420 2725 3035 3350 3615 3875 4130 **4375**  
1980 2525 2885 3245 3615 3985 4300 4610 4910 5205  
2195 2745 3115 3485 3850 4230 4615 4960 5270 5575 5875 6195  
2860 3490 3905 4325 4740 5160 5575 6010 6440 6830 7210 7585 7910 8275 8635 8790

7 12 14 17 20 23 26 29 32 33 35 38 41 42 43 46 49 51 52 54 58 61 64 67 72 75 84  
0,5 0,8 1,0 1,2 1,4 1,6 1,8 2,0 2,2 2,3 2,4 2,6 2,8 2,9 3,0 3,2 3,4 3,5 3,6 3,7 4,0 4,2 4,4 4,6 5,0 5,2 5,8

2510 3195 3675 4165 4605 5040 5450 5850  
2790 3550 4085 4625 5115 5600 6055 **6500**  
3675 4600 5235 5895 6540 7130 7715 8300 8835 9100  
1770 2250 2585 2925 3260 3600 3885 4160  
1965 2500 2875 3250 3625 4000 4315 **4625**  
2340 2975 3420 3870 4310 4760 5135 5505  
2585 3240 3685 4130 4595 5050 5510 5920 6295 6475  
3375 4115 4605 5100 5625 6135 6650 7175 7685 7950 8155 8610 9055 9250

7 12 14 17 20 23 26 29 32 35 38 41 43 46 49 51 52 54 58 61 64 67 72 75 84  
0,5 0,8 1,0 1,2 1,4 1,6 1,8 2,0 2,2 2,4 2,6 2,8 3,0 3,2 3,4 3,5 3,6 3,7 4,0 4,2 4,4 4,6 5,0 5,2 5,8

2300 2925 3320 3715 4170 4635 5020 5400 5805 6210  
2555 3250 3690 4125 4635 5150 5580 6000 6450 **6900**  
3365 4210 4760 5290 5830 6455 7095 7640 8150 8675 9220 9770  
1625 2070 2345 2610 2945 3285 3555 3825 4105 4385  
1805 2300 2605 2900 3270 3650 3950 4250 4565 **4875**  
2150 2735 3100 3450 3890 4345 4705 5055 5430 5800  
2380 2980 3365 3745 4100 4560 5030 5415 5775 6140 6520 6905  
3105 3785 4240 4690 5095 5515 5935 6475 6975 7455 7880 8305 8710 9150 9585 9795

7 12 14 17 20 23 26 29 32 35 38 41 43 46 49 51 52 54 58 61 64 67 72 75 84  
0,5 0,8 1,0 1,2 1,4 1,6 1,8 2,0 2,2 2,4 2,6 2,8 3,0 3,2 3,4 3,5 3,6 3,7 4,0 4,2 4,4 4,6 5,0 5,2 5,8

2300 2925 3320 3715 4170 4635 5020 5400 5805 6210  
2555 3250 3690 4125 4635 5150 5580 6000 6450 **6900**  
3365 4210 4760 5290 5830 6455 7095 7640 8150 8675 9220 9770  
1625 2070 2345 2610 2945 3285 3555 3825 4105 4385  
1805 2300 2605 2900 3270 3650 3950 4250 4565 **4875**  
2150 2735 3100 3450 3890 4345 4705 5055 5430 5800  
2380 2980 3365 3745 4100 4560 5030 5415 5775 6140 6520 6905  
3105 3785 4240 4690 5095 5515 5935 6475 6975 7455 7880 8305 8710 9150 9585 9795

## Twin Implement - T404 - T421 - T423 - T478

X-ply tires for transport equipment



SIZE	LI/SS	New tire		Tire in service		SLR mm +/- 2%	RC mm +/- 2,5%	Rim	Speed Km/h	PRESSURE	
		SW mm +/- 1,5%	OD mm +/- 1,5%	SW max mm	OD max mm					psi	bar
750/60-30.5 TL T404	178A8 ↻	750	1650	804	1738	710	4830	AG24.00	Free Rolling		
									50		
									40		
									10		
	166A8 ↻	740	4870	Driving wheel							
				50							
				40							
				25							
			10								
			10 C								

SIZE	LI/SS	New tire		Tire in service		SLR mm +/- 2%	RC mm +/- 2,5%	Rim	Speed Km/h	PRESSURE	
		SW mm +/- 1,5%	OD mm +/- 1,5%	SW max mm	OD max mm					psi	bar
800/45-30.5 TL T404	178A8 ↻	800	1500	862	1545	650	4455	AG28.00	Free Rolling		
									50		
									40		
									10		
	166A8 ↻	670	4485	Driving wheel							
				50							
				40							
				25							
			10								
			10 C								

SIZE	LI/SS	New tire		Tire in service		SLR mm +/- 2%	RC mm +/- 2,5%	Rim	Speed Km/h	PRESSURE	
		SW mm +/- 1,5%	OD mm +/- 1,5%	SW max mm	OD max mm					psi	bar
800/45-30.5 TL T423	178A8 ↻	800	1500	840	1536	660	4420	AG28.00	Free Rolling		
									50		
									40		
									10		
	166A8 ↻	680	4460	Driving wheel							
				50							
				40							
				25							
			10								
			10 C								

SIZE	LI/SS	New tire		Tire in service		SLR mm +/- 2%	RC mm +/- 2,5%	Rim	Speed Km/h	PRESSURE	
		SW mm +/- 1,5%	OD mm +/- 1,5%	SW max mm	OD max mm					psi	bar
850/50-30.5 TL T404	179A8 ↻	850	1650	920	1684	691	4840	AG28.00	Free Rolling		
									50		
									40		
									10		
	167A8 ↻	723	4880	Driving wheel							
				50							
				40							
				25							
			10								
			10 C								



# T421

# T423

# T428

# T440



Agricultural multi purpose tires. Low ground pressure tires for field and road. The cord material and rubber compound allow the tire to be used at speeds up to 70 Km/h as well as in heavy duty applications.

We recommend this tire for machines and implements with a high degree of road service.

SIZE	New tire		Tire in service		SLR mm	RC mm	SRI	Rim	Type	Speed Km/h	PRESSURE	
	SW mm	OD mm	SW max mm	OD max mm							psi	bar
620/50B22.5 160D	625	1170	675	1235	535	3555	555	AG20.00	TL	70		
										65		
T423										40		
										10		
										0		

SIZE	New tire		Tire in service		SLR mm	RC mm	SRI	Rim	Type	Speed Km/h	PRESSURE	
	SW mm	OD mm	SW max mm	OD max mm							psi	bar
650/45B22.5 160D	650	1160	697	1197	533	3505	550	AG20.00	TL	70		
										65		
T440										40		
										10		
										0		

SIZE	New tire		Tire in service		SLR mm	RC mm	SRI	Rim	Type	Speed Km/h	PRESSURE	
	SW mm	OD mm	SW max mm	OD max mm							psi	bar
710/40B22.5 161D	720	1165	774	1180	535	3554	535	AG24.00	TL	70		
										65		
T423										40		
										10		
										0		

SIZE		
<b>620/50B22.5</b>	<b>160D</b>	<b>T423</b>
<b>650/45B22.5</b>	<b>160D</b>	<b>T440</b>
<b>710/40B22.5</b>	<b>161D</b>	<b>T423</b>
<b>620/55B26.5</b>	<b>166D</b>	<b>T421</b>

SIZE		
<b>650/55B30.5</b>	<b>168D</b>	<b>T428</b>
<b>750/50B30.5</b>	<b>173D</b>	<b>T428</b>
<b>850/45B30.5</b>	<b>176D</b>	<b>T423</b>

14	17	20	23	26	29	32	35	38	41	43	46	49	52	55	58	62	67
1,0	1,2	1,4	1,6	1,8	2,0	2,2	2,4	2,6	2,8	3,0	3,2	3,4	3,6	3,8	4,0	4,3	4,6
1690	1875	2045	2210	2350	2480	2670	2865	3050	3230	3325	3415	3635	3870	3990	4095		
1855	2060	2245	2430	2580	2725	2935	3150	3350	3550	3655	3750	3995	4250	4385	<b>4500</b>		
2525	2800	3055	3305	3510	3705	3995	4285	4555	4830	4970	5100	5435	5780	5960	6120		
3100	3420	3740	4030	4310	4585	4800	5070	5410	5730	6045	6360	6505	6720	6980	7385	7840	8120
4305	4750	5195	5595	5985	6365	6670	7045	7510	7960	8395	8830	9030	9330	9695	10255	10885	11280

14	17	20	23	26	29	32	35	38	41	43	46	49	52	55	58	62	67
1,0	1,2	1,4	1,6	1,8	2,0	2,2	2,4	2,6	2,8	3,0	3,2	3,4	3,6	3,8	4,0	4,3	4,6
1640	1820	1985	2150	2315	2480	2640	2800	2970	3140	3280	3415	3585	3755	3925	4095		
1800	2000	2180	2360	2545	2725	2900	3075	3265	3450	3600	3750	3935	4125	4310	<b>4500</b>		
2450	2720	2970	3210	3460	3705	3945	4180	4440	4690	4900	5100	5355	5610	5865	6120		
3005	3320	3630	3910	4185	4485	4765	5040	5310	5595	5890	6180	6410	6670	6925	7220	7660	8100
4175	4610	5045	5435	5815	6225	6620	7000	7375	7770	8180	8585	8900	9265	9620	10025	10640	11280

14	17	20	23	26	29	32	35	38	41	43	46	49	52	55	58	62	67
1,0	1,2	1,4	1,6	1,8	2,0	2,2	2,4	2,6	2,8	3,0	3,2	3,4	3,6	3,8	4,0	4,3	4,6
1690	1875	2075	2275	2415	2550	2710	2865	3050	3230	3380	3525	3695	3870	4040	4210		
1855	2060	2280	2500	2655	2800	2975	3150	3350	3550	3715	3875	4065	4250	4440	<b>4625</b>		
2525	2800	3100	3400	3610	3810	4045	4285	4555	4830	5050	5270	5525	5780	6035	6290		
3100	3420	3740	4085	4435	4715	4935	5175	5445	5730	6045	6360	6610	6885	7150	7445	7885	8325
4305	4750	5195	5675	6160	6545	6855	7190	7560	7960	8395	8835	9180	9565	9935	10340	10955	11565

## Twin Ampt - T421 - T423 - T428 - T440

X-ply tires for transport equipment



SIZE	New tire		Tire in service		SLR mm	RC mm	SRI	Rim	Type	Speed Km/h	PRESSURE		
	SW mm	OD mm	SW max mm	OD max mm							psi	bar	MAX. LOAD kg
620/55B26.5 166D	630	1360	675	1403	620	4100	635	AG20.00	TL	70			
										65			
T421										40			
										10			
										0			

SIZE	New tire		Tire in service		SLR mm	RC mm	SRI	Rim	Type	Speed Km/h	PRESSURE		
	SW mm	OD mm	SW max mm	OD max mm							psi	bar	MAX. LOAD kg
650/55B30.5 168D	640	1490	697	1540	675	4480	700	AG20.00	TL	70			
										65			
T428										40			
										10			
										0			

SIZE	New tire		Tire in service		SLR mm	RC mm	SRI	Rim	Type	Speed Km/h	PRESSURE		
	SW mm	OD mm	SW max mm	OD max mm							psi	bar	MAX. LOAD kg
750/50B30.5 173D	750	1530	804	1577	690	4605	715	AG24.00	TL	70			
										65			
T428										40			
										10			
										0			

SIZE	New tire		Tire in service		SLR mm	RC mm	SRI	Rim	Type	Speed Km/h	PRESSURE		
	SW mm	OD mm	SW max mm	OD max mm							psi	bar	MAX. LOAD kg
850/45B30.5 176D	830	1530	921	1593	690	4635	725	AG28.00	TL	70			
										65			
T423										40			
										10			
										0			

According to availability

14	17	20	23	26	29	32	35	38	41	43	46	49	52	55	58	62	67
1,0	1,2	1,4	1,6	1,8	2,0	2,2	2,4	2,6	2,8	3,0	3,2	3,4	3,6	3,8	4,0	4,3	4,6
1940	2150	2390	2640	2805	2960	3140	3320	3535	3755	3925	4095	4265	4435	4630	4825		
2130	2360	2625	2900	3080	3250	3450	3650	3885	4125	4315	4500	4690	4875	5090	<b>5300</b>		
2900	3210	3575	3945	4190	4420	4695	4965	5285	5610	5870	6120	6375	6630	6920	7210		
3565	3920	4285	4710	5145	5470	5725	6005	6315	6640	7015	7390	7675	7995	8280	8565	9045	9540
4950	5445	5950	6540	7145	7595	7955	8340	8765	9225	9745	10265	10665	11105	11500	11895	12565	13250

14	17	20	23	26	29	32	35	38	41	43	46	49	52	55	58	62	67
1,0	1,2	1,4	1,6	1,8	2,0	2,2	2,4	2,6	2,8	3,0	3,2	3,4	3,6	3,8	4,0	4,3	4,6
2230	2480	2720	2960	3145	3320	3595	3870	4095	4325	4505	4685	4895	5095				
2455	2725	2990	3250	3455	3650	3950	4250	4500	4750	4955	5150	5375	<b>5600</b>				
3335	3705	4065	4420	4700	4965	5370	5780	6120	6460	6735	7005	7315	7615				
4095	4520	4950	5360	5765	6130	6430	6805	7285	7735	8125	8510	8815	9165	9485	9830		
5685	6280	6870	7440	8010	8515	8930	9455	10115	10740	11280	11815	12240	12730	13175	13650		

14	17	20	23	26	29	32	35	38	41	43	46	49	52	55	58	62	67
1,0	1,2	1,4	1,6	1,8	2,0	2,2	2,4	2,6	2,8	3,0	3,2	3,4	3,6	3,8	4,0	4,3	4,6
2570	2865	3140	3415	3645	3870	4150	4435	4700	4960	5125	5280	5595	5915				
2825	3150	3450	3750	4005	4250	4560	4875	5165	5450	5630	5800	6145	<b>6500</b>				
3840	4285	4695	5100	5445	5780	6205	6630	7020	7410	7660	7890	8360	8840				
4705	5215	5720	6190	6655	7090	7465	7895	8385	8870	9315	9760	10020	10370	10765	11325		
6535	7245	7945	8595	9240	9850	10370	10965	11645	12320	12940	13560	13915	14405	14950	15730		

14	17	20	23	26	29	32	35	38	41	43	46	49	52	55	58	62	67
1,0	1,2	1,4	1,6	1,8	2,0	2,2	2,4	2,6	2,8	3,0	3,2	3,4	3,6	3,8	4,0	4,3	4,6
2845	3140	3445	3755	4040	4325	4575	4825	5140	5460	5690	5915	6190	6460				
3130	3450	3790	4125	4440	4750	5030	5300	5650	6000	6255	6500	6800	<b>7100</b>				
4255	4690	5150	5610	6040	6460	6840	7210	7685	8160	8505	8840	9250	9655				
5240	5745	6265	6790	7315	7830	8310	8765	9180	9645	10195	10745	11130	11570	11985	12450		
7280	7980	8700	9430	10160	10875	11545	12170	12750	13395	14160	14925	15455	16070	16645	17290		

For technical notes about pressure tables please refer to page 260.

## Twin Ampt - T421 - T423 - T428 - T440

X-ply tires for transport equipment



# AW305



# AF302



# T452



# T306



# AW309 Flotation



The Implement tires are metric size marked, tubeless, and Load/Speed index rated, which gives a higher load capacity and higher permitted speed (40 - 50 kph) than previous tires. This line is recommended for trailers and other agricultural implements such as spreaders, balers, ploughs, drills.

The tread design and the rounded shoulders offer soft ground contact with minimal damage when turning, in addition to a low rolling resistance on road transport. Available in a wide range of sizes to cover all normal requirements.

SIZE	LI/SS	New tire		Tire in service		SLR mm	RC mm	Rim	Type/Tube	Speed Km/h
		SW mm	OD mm	SW max mm	OD max mm					
200/95-12	101A8 ↻	198	684	213	711	307	2041	4.25	TL 7.00-12	Free Rolling
	50									
AF302	89A8 ↻	198	684	213	711	316	2055	4.25	TL 7.00-12	10
										Driving wheel
										50
										40
										10



SIZE		
200/95-12	101A8	AF302
260/90-13	121A8	AF302
260/70-15.3	116A8	AW305
260/70-15.3	126A8	AW305
260/70-15.3	131A8	AW305
300/80-15.3	123A8	T452
300/80-15.3	141A8	T452
300/80-15.3	132A8	AW305
300/80-15.3	141A8	AW305
320/80-15.3	145A8	AW305
180/90-16	100A8	AF302
190/90-16	108A8	AF302
200/90-16	111A8	AF302
210/95-16	120A8	AF302
260/70-16	134A8	AW305

SIZE		
340/55-16	140A8	AW305
340/55-16	140A8	AW309
360/65-16	148A8	AW305
360/70-16	137A8	AW305
380/55-17	138A8	AW305
NEW 380/55-17	138A8	AW309
420/55-17	143A8	T452
480/45-17	146A8	AW305
NEW 480/45-17	150A8	AW309
NEW 500/50-17	149A8	AW309
520/50-17	159A8	T306
500/55-20	150A8	AW309

SIZE		Inches sizes
10.0/80-12	8 PR	AW305
10.0/80-12	10 PR	AW305

PRESSURE																																
psi	7	12	14	17	20	23	26	29	32	35	36	38	41	42	43	46	49	51	52	54	55	58	59									
bar	0,5	0,8	1,0	1,2	1,4	1,6	1,8	2,0	2,2	2,4	2,5	2,6	2,8	2,9	3,0	3,2	3,4	3,5	3,6	3,7	3,8	4,0	4,1									
MAX. LOAD kg																																
	285	360	410	465	515	565	610	655	700	745																						
	315	400	455	515	570	630	680	730	780	825																						
	415	520	590	660	730	800	870	935	990	1050	1105	1170																				
	200	250	290	330	365	405	435	465	495	520																						
	220	280	320	365	405	450	485	515	550	580																						
	290	365	415	465	515	570	620	665	700	740	780	820																				

Implement standard - AW305 - AF302 - T452 - T306 - AW309

X-ply tires for transport equipment



SIZE	LI/SS	New tire		Tire in service		SLR mm	RC mm	Rim	Type/Tube	Speed Km/h
		SW mm	OD mm	SW max mm	OD max mm					
260/90-13 AF302	121A8 ⊕→	262	795	279	831	350	2378	6.00F	TL 9.00-13	Free Rolling
	109A8 ⊕									362
										10
										Driving wheel
										50
										40
										10

SIZE	LI/SS	New tire		Tire in service		SLR mm	RC mm	Rim	Type/Tube	Speed Km/h
		SW mm	OD mm	SW max mm	OD max mm					
260/70-15.3 AW305	116A8 ⊕→	274	760	279	778	332	2265	9.00	TL 10.0/75-15.3	Free Rolling
	104A8 ⊕									354
										10
										Driving wheel
										50
										40
										10

SIZE	LI/SS	New tire		Tire in service		SLR mm	RC mm	Rim	Type/Tube	Speed Km/h
		SW mm	OD mm	SW max mm	OD max mm					
260/70-15.3 AW305	126A8 ⊕→	274	760	279	778	332	2265	9.00	TL 10.0/75-15.3	Free Rolling
	114A8 ⊕									354
										10
										Driving wheel
										50
										40
										10

SIZE	LI/SS	New tire		Tire in service		SLR mm	RC mm	Rim	Type/Tube	Speed Km/h
		SW mm	OD mm	SW max mm	OD max mm					
260/70-15.3 AW305	131A8 ⊕→	274	760	279	778	330	2280	9.00	TL 10.0/75-15.3	Free Rolling
	119A8 ⊕									354
										10
										Driving wheel
										50
										40
										10

PRESSURE		7	12	14	17	20	23	26	29	32	35	38	41	42	43	46	49	51	52	54	55	58	59
psi	bar	0,5	0,8	1,0	1,2	1,4	1,6	1,8	2,0	2,2	2,4	2,6	2,8	2,9	3,0	3,2	3,4	3,5	3,6	3,7	3,8	4,0	4,1
MAX. LOAD kg																							
		490	620	715	810	895	980	1070	1155	1230	1305												
		540	690	795	900	995	1090	1185	1285	1370	<b>1450</b>												
		715	895	1020	1145	1270	1385	1500	1620	1740	1850	1945	2055										
		345	440	500	565	630	695	765	835	880	925												
		385	485	560	630	700	775	850	925	980	<b>1030</b>												
		505	630	715	805	890	980	1065	1155	1250	1325	1390	1460										

PRESSURE		7	12	14	17	20	23	26	29	32	35	38	41	42	43	46	49	51	52	54	55	58	59
psi	bar	0,5	0,8	1,0	1,2	1,4	1,6	1,8	2,0	2,2	2,4	2,6	2,8	2,9	3,0	3,2	3,4	3,5	3,6	3,7	3,8	4,0	4,1
MAX. LOAD kg																							
		425	540	620	700	765	835	905	980	1055	1125												
		470	600	685	775	850	925	1010	1090	1170	<b>1250</b>												
		620	775	880	990	1095	1185	1275	1375	1475	1575	1670	1770										
		300	380	435	490	540	585	640	700	755	810												
		335	425	485	545	600	650	710	775	835	<b>900</b>												
		440	550	625	695	770	835	895	970	1045	1125	1200	1275										

PRESSURE		7	12	14	17	20	23	26	29	32	35	38	41	43	46	49	52	55	58	59			
psi	bar	0,5	0,8	1,0	1,2	1,4	1,6	1,8	2,0	2,2	2,4	2,6	2,8	3,0	3,2	3,4	3,6	3,8	4,0	4,1			
MAX. LOAD kg																							
		425	540	620	700	765	835	905	980	1055	1125	1195	1260	1305	1350	1440	1530						
		470	600	685	775	850	925	1010	1090	1170	1250	1325	1400	1450	1500	1600	<b>1700</b>						
		620	775	880	990	1095	1185	1275	1375	1475	1575	1670	1770	1860	1950	2010	2085	2170	2295	2360			
		300	380	435	490	540	585	640	700	755	810	855	900	930	955	1010	1060						
		335	425	485	545	600	650	710	775	835	900	950	1000	1030	1060	1120	<b>1180</b>						
		440	550	625	695	770	835	895	970	1045	1125	1200	1275	1335	1395	1425	1475	1530	1600	1640			

PRESSURE		7	12	17	23	29	35	38	41	43	46	49	52	55	58	67	72	78	84
psi	bar	0,5	0,8	1,2	1,6	2,0	2,4	2,6	2,8	3,0	3,2	3,4	3,6	3,8	4,0	4,6	5,0	5,4	5,8
MAX. LOAD kg																			
		425	540	700	835	980	1125	1195	1260	1305	1350	1440	1530	1600	1665	1730	1755		
		470	600	775	925	1090	1250	1325	1400	1450	1500	1600	1700	1775	1850	1925	<b>1950</b>		
		620	775	990	1185	1375	1575	1670	1770	1860	1950	2010	2085	2170	2295	2590	2635	2700	2750
		300	380	490	585	700	810	855	900	930	955	1010	1060	1110	1155	1205	1225		
		335	425	545	650	775	900	950	1000	1030	1060	1120	1180	1230	1285	1340	<b>1360</b>		
		440	550	695	835	970	1125	1200	1275	1335	1395	1425	1475	1530	1600	1800	1835	1880	1920

### Implement standard - AW305 - AF302 - T452 - T306 - AW309

X-ply tires for transport equipment



SIZE	LI/SS	New tire		Tire in service		SLR mm	RC mm	Rim	Type/Tube	Speed Km/h
		SW mm	OD mm	SW max mm	OD max mm					
300/80-15.3	123A8 ⊖→	305	900	319	902	390	2685	9.00	TL	Free Rolling
	50									
										40
										10
T452	111A8 ⊖					403	2691			Driving wheel
										50
										40
										25
										10
										10 C

SIZE	LI/SS	New tire		Tire in service		SLR mm	RC mm	Rim	Type/Tube	Speed Km/h
		SW mm	OD mm	SW max mm	OD max mm					
300/80-15.3	141A8 ⊖→	300	890	310	902	383	2601	9.00	TL	Free Rolling
	50									
										40
										10
T452	129A8 ⊖									Driving wheel
										50
										40
										25
										10
										10 C

According to availability

SIZE	LI/SS	New tire		Tire in service		SLR mm	RC mm	Rim	Type/Tube	Speed Km/h
		SW mm	OD mm	SW max mm	OD max mm					
300/80-15.3	132A8 ⊖→	296	870	319	902	372	2595	9.00	TL 11.5/80-15.3	Free Rolling
	50									
										40
										10
AW305	120A8 ⊖					407	2642			Driving wheel
										50
										40
										10

SIZE	LI/SS	New tire		Tire in service		SLR mm	RC mm	Rim	Type/Tube	Speed Km/h
		SW mm	OD mm	SW max mm	OD max mm					
300/80-15.3	141A8 ⊖→	300	870	319	902	380	2610	9.00	TL 11.5/80-15.3	Free Rolling
	50									
										40
										10
AW305	129A8 ⊖					407	2642			Driving wheel
										50
										40
										10

PRESSURE		7	12	14	17	20	23	26	29	32	33	35	38	41	42	43	46	49	51	52	54	55	58	59	67
psi	bar	0,5	0,8	1,0	1,2	1,4	1,6	1,8	2,0	2,2	2,3	2,4	2,6	2,8	2,9	3,0	3,2	3,4	3,5	3,6	3,7	3,8	4,0	4,1	4,6
MAX. LOAD kg																									
		600	765	875	980	1085	1190	1290	1395																
		670	850	970	1090	1205	1320	1435	1550	<b>1550</b>															
		880	1100	1250	1395	1540	1680	1820	1960	2100	2170														
		425	540	620	695	775	855	920	980																
		470	600	685	775	860	950	1020	<b>1090</b>																
		560	715	820	920	1025	1130	1215	1295																
		620	775	885	990	1095	1200	1310	1405	1485	1525														
		810	985	1105	1225	1345	1465	1585	1705	1825	1885	1935	2035	2140	2180										

PRESSURE		7	12	14	17	20	23	26	29	32	35	38	41	43	46	49	52	55	58	61	67	72	75	84
psi	bar	0,5	0,8	1,0	1,2	1,4	1,6	1,8	2,0	2,2	2,4	2,6	2,8	3,0	3,2	3,4	3,6	3,8	4,0	4,2	4,6	5,0	5,2	5,8
MAX. LOAD kg																								
		600	765	875	980	1085	1190	1290	1395	1485	1575	1690	1800	1855	1910	2015	2125	2220	2320					
		670	850	970	1090	1205	1320	1435	1550	1650	1750	1875	2000	2065	2120	2240	2360	2470	<b>2575</b>					
		880	1100	1250	1395	1540	1680	1820	1960	2100	2230	2350	2480	2630	2785	2855	2955	3055	3205	3340	3605			
		425	540	620	695	775	855	920	980	1040	1095	1175	1260	1305	1350	1440	1530	1600	1665					
		470	600	685	775	860	950	1020	1090	1155	1215	1305	1400	1450	1500	1600	1700	1775	<b>1850</b>					
		560	715	820	920	1025	1130	1215	1295	1375	1445	1555	1665	1725	1785	1905	2025	2110	2200					
		620	775	885	990	1095	1200	1310	1405	1485	1565	1635	1720	1835	1950	2010	2085	2170	2295	2405	2590			
		810	985	1105	1225	1345	1465	1585	1705	1825	1935	2035	2140	2220	2315	2405	2510	2630	2765	2880	2980	3255	3390	3700

PRESSURE		7	12	14	17	20	23	26	29	32	35	38	41	43	46	49	51	52	54	55	58	59	67	
psi	bar	0,5	0,8	1,0	1,2	1,4	1,6	1,8	2,0	2,2	2,4	2,6	2,8	3,0	3,2	3,4	3,5	3,6	3,7	3,8	4,0	4,1	4,6	
MAX. LOAD kg																								
		600	765	875	980	1085	1190	1290	1395	1485	1575	1690	1800											
		670	850	970	1090	1205	1320	1435	1550	1650	1750	1875	<b>2000</b>											
		880	1100	1250	1395	1540	1680	1820	1960	2100	2230	2350	2480	2630	2785									
		425	540	620	695	775	855	920	980	1040	1095	1175	1260											
		470	600	685	775	860	950	1020	1090	1155	1215	1305	<b>1400</b>											
		620	775	885	990	1095	1200	1310	1405	1485	1565	1635	1720	1835	1950									

PRESSURE		7	12	17	23	26	29	32	35	38	41	43	46	49	52	55	58	61	64	67				
psi	bar	0,5	0,8	1,2	1,6	1,8	2,0	2,2	2,4	2,6	2,8	3,0	3,2	3,4	3,6	3,8	4,0	4,2	4,4	4,6				
MAX. LOAD kg																								
		600	765	980	1190	1290	1395	1485	1575	1690	1800	1855	1910	2015	2125	2220	2320							
		670	850	1090	1320	1435	1550	1650	1750	1875	2000	2065	2120	2240	2360	2470	<b>2575</b>							
		880	1100	1395	1680	1820	1960	2100	2230	2350	2480	2630	2785	2855	2955	3055	3205	3340	3475	3605				
		425	540	695	855	920	980	1040	1095	1175	1260	1305	1350	1440	1530	1600	1665							
		470	600	775	950	1020	1090	1155	1215	1305	1400	1450	1500	1600	1700	1775	<b>1850</b>							
		620	775	990	1200	1310	1405	1485	1565	1635	1720	1835	1950	2010	2085	2170	2295	2405	2500	2590				

**Implement standard - AW305 - AF302 - T452 - T306 - AW309**

X-ply tires for transport equipment



SIZE	LI/SS	New tire		Tire in service		SLR mm	RC mm	Rim	Type/Tube	Speed Km/h
		SW mm	OD mm	SW max mm	OD max mm					
320/80-15.3  AW305	145A8 ↻	322	897	345	936	396	2691	9.00	TL 12.5/80-15.3	Free Rolling
										40
										10
	133A8 ↻					424	2702			Driving wheel
										50
										40
										10

SIZE	LI/SS	New tire		Tire in service		SLR mm	RC mm	Rim	Type/Tube	Speed Km/h
		SW mm	OD mm	SW max mm	OD max mm					
180/90-16  AF302	100A8 ↻	175	728	192	753	307	2162	4.00E	TL 6.00-16	Free Rolling
										40
										10
	88A8 ↻					337	2194			Driving wheel
										50
										40
										10

SIZE	LI/SS	New tire		Tire in service		SLR mm	RC mm	Rim	Type/Tube	Speed Km/h
		SW mm	OD mm	SW max mm	OD max mm					
190/90-16  AF302	108A8 ↻	192	746	205	772	331	2223	4.50E	TL 6.50/7.00-16	Free Rolling
										40
										10
	96A8 ↻					343	2245			Driving wheel
										50
										40
										10

SIZE	LI/SS	New tire		Tire in service		SLR mm	RC mm	Rim	Type/Tube	Speed Km/h
		SW mm	OD mm	SW max mm	OD max mm					
200/90-16  AF302	111A8 ↻	204	764	213	792	338	2227	5.00F	TL 6.50/7.00-16	Free Rolling
										40
										10
	99A8 ↻					354	2305			Driving wheel
										50
										40
										10

SIZE	LI/SS	New tire		Tire in service		SLR mm	RC mm	Rim	Type/Tube	Speed Km/h
		SW mm	OD mm	SW max mm	OD max mm					
210/95-16  AF302	120A8 ↻	218	802	231	833	347	2392	5.50F	TL 7.50-16	Free Rolling
										40
										10
	108A8 ↻					373	2420			Driving wheel
										50
										40
										10

PRESSURE		7	12	17	23	26	29	32	35	38	41	43	46	49	52	55	58	61	64	67
psi	bar	0,5	0,8	1,2	1,6	1,8	2,0	2,2	2,4	2,6	2,8	3,0	3,2	3,4	3,6	3,8	4,0	4,2	4,4	4,6
MAX. LOAD kg																				
		655	835	1060	1305	1420	1530	1645	1755	1885	2015	2075	2125	2255	2385	2500	2610			
		725	925	1180	1450	1575	1700	1825	1950	2095	2240	2305	2360	2505	2650	2775	<b>2900</b>			
		955	1200	1510	1830	2000	2155	2305	2455	2605	2760	2940	3120	3185	3295	3410	3590	3755	3910	4060
		460	585	765	925	995	1060	1145	1225	1330	1440	1485	1530	1620	1710	1785	1855			
		510	650	850	1030	1105	1180	1270	1360	1480	1600	1650	1700	1800	1900	1980	<b>2060</b>			
		675	840	1075	1310	1420	1520	1610	1705	1815	1925	2075	2230	2285	2365	2450	2575	2685	2790	2885

PRESSURE		7	12	14	17	20	23	26	29	32	33	38	41	42	43	46	49	51	52	54	55	58	59	67
psi	bar	0,5	0,8	1,0	1,2	1,4	1,6	1,8	2,0	2,2	2,3	2,6	2,8	2,9	3,0	3,2	3,4	3,5	3,6	3,7	3,8	4,0	4,1	4,6
MAX. LOAD kg																								
		310	395	450	505	565	620	670	720															
		345	435	500	560	625	690	745	<b>800</b>															
		450	565	640	715	790	870	950	1025	1090	1120													
		215	275	320	360	400	440	470	505															
		240	305	355	400	445	485	525	<b>560</b>															
		320	400	455	510	565	620	670	720	765	785													

PRESSURE		7	12	14	17	20	23	26	29	32	35	38	41	42	43	46	49	51	52	54	55	58	59	67
psi	bar	0,5	0,8	1,0	1,2	1,4	1,6	1,8	2,0	2,2	2,4	2,6	2,8	2,9	3,0	3,2	3,4	3,5	3,6	3,7	3,8	4,0	4,1	4,6
MAX. LOAD kg																								
		335	430	490	555	615	675	730	790	845	900													
		375	475	545	615	685	750	815	875	940	<b>1000</b>													
		490	615	700	785	870	950	1035	1115	1190	1265	1340	1415											
		235	300	345	395	435	475	515	555	595	640													
		265	335	385	435	485	530	575	615	665	<b>710</b>													
		345	435	495	555	620	675	730	785	835	890	950	1005											

PRESSURE		7	12	14	17	20	23	26	29	32	35	38	41	42	43	46	49	51	52	54	55	58	59	67
psi	bar	0,5	0,8	1,0	1,2	1,4	1,6	1,8	2,0	2,2	2,4	2,6	2,8	2,9	3,0	3,2	3,4	3,5	3,6	3,7	3,8	4,0	4,1	4,6
MAX. LOAD kg																								
		365	465	535	605	660	720	790	855	920	980													
		405	515	590	670	735	800	875	950	1020	<b>1090</b>													
		535	665	760	855	945	1025	1100	1190	1285	1375	1455	1545											
		260	330	380	425	465	505	555	605	650	695													
		285	365	420	475	520	560	615	670	725	<b>775</b>													
		380	475	540	605	670	720	770	835	905	970	1035	1095											

PRESSURE		7	12	14	17	20	23	26	29	32	35	38	41	43	46	49	51	52	54	55	58	59	67	
psi	bar	0,5	0,8	1,0	1,2	1,4	1,6	1,8	2,0	2,2	2,4	2,6	2,8	3,0	3,2	3,4	3,5	3,6	3,7	3,8	4,0	4,1	4,6	
MAX. LOAD kg																								
		410	520	600	675	755	835	895	955	1025	1095	1175	1260											
		455	580	665	750	835	925	995	1060	1140	1215	1305	<b>1400</b>											
		600	750	855	960	1060	1165	1275	1365	1445	1530	1625	1720	1835	1950									
		290	370	425	475	530	585	630	675	730	785	845	900											
		325	410	470	530	590	650	700	750	810	875	935	<b>1000</b>											
		425	535	605	675	750	825	895	960	1020	1090	1165	1240	1315	1395									

## Implement standard - AW305 - AF302 - T452 - T306 - AW309

X-ply tires for transport equipment



SIZE	LI/SS	New tire		Tire in service		SLR mm	RC mm	Rim	Type/Tube	Speed Km/h
		SW mm	OD mm	SW max mm	OD max mm					
260/70-16 AW305	134A8 ⊕→	265	776	279	796	336	2303	W8	TL 10.5/65-16	Free Rolling
	122A8 ⊕									348
										10
										Driving wheel
										50
										40
										10

SIZE	LI/SS	New tire		Tire in service		SLR mm	RC mm	Rim	Type/Tube	Speed Km/h
		SW mm	OD mm	SW max mm	OD max mm					
340/55-16 AW305	140A8 ⊕→	342	777	370	807	333	2331	11.00	TL 13.0/55-16	Free Rolling
	128A8 ⊕									364
										10
										Driving wheel
										50
										40
										10

SIZE	LI/SS	New tire		Tire in service		SLR mm	RC mm	Rim	Type/Tube	Speed Km/h
		SW mm	OD mm	SW max mm	OD max mm					
340/55-16 AW309	140A8 ⊕→	342	766	370	800	330	2295	11.00	TL	Free Rolling
	128A8 ⊕									355
										10
										Driving wheel
										50
										40
										10

SIZE	LI/SS	New tire		Tire in service		SLR mm	RC mm	Rim	Type/Tube	Speed Km/h
		SW mm	OD mm	SW max mm	OD max mm					
360/65-16 AW305	148A8 ⊕→	362	880	386	907	377	2640	11.00	TL	Free Rolling
	136A8 ⊕									396
										10
										Driving wheel
										50
										40
										10

SIZE	LI/SS	New tire		Tire in service		SLR mm	RC mm	Rim	Type/Tube	Speed Km/h
		SW mm	OD mm	SW max mm	OD max mm					
360/70-16 AW305	137A8 ⊕→	362	905	386	946	380	2697	11.00	TL 13.0/75-16 14.0/65-16	Free Rolling
	125A8 ⊕									412
										10
										Driving wheel
										50
										40
										10



PRESSURE																	
psi	7	12	17	23	29	35	41	46	52	58	61	64	67	70	72	79	84
bar	0,5	0,8	1,2	1,6	2,0	2,4	2,8	3,2	3,6	4,0	4,2	4,4	4,6	4,8	5,0	5,4	5,8
MAX. LOAD kg																	
	460	585	765	925	1060	1225	1395	1485	1665	1800	1830	1855	1875	1895	1910		
	510	650	850	1030	1180	1360	1550	1650	1850	2000	2035	2060	2085	2105	<b>2120</b>		
	675	840	1080	1310	1520	1705	1925	2160	2295	2505	2615	2710	2800	2830	2855	2930	2990
	325	415	540	655	765	875	980	1035	1155	1260	1285	1305	1320	1335	1350		
	365	460	600	730	850	975	1090	1150	1285	1400	1425	1450	1470	1485	<b>1500</b>		
	480	600	765	925	1080	1230	1380	1520	1605	1740	1820	1890	1960	1985	2005	2065	2115

PRESSURE																				
psi	7	12	17	23	26	29	32	35	38	41	43	46	49	52	55	58	61	64	67	
bar	0,5	0,8	1,2	1,6	1,8	2,0	2,2	2,4	2,6	2,8	3,0	3,2	3,4	3,6	3,8	4,0	4,2	4,4	4,6	
MAX. LOAD kg																				
	565	720	925	1125	1215	1305	1415	1530	1620	1710	1785	1855	1935	2015	2130	2250				
	630	800	1030	1250	1350	1450	1575	1700	1800	1900	1980	2060	2150	2240	2370	<b>2500</b>				
	830	1035	1315	1590	1720	1850	1970	2105	2260	2405	2530	2645	2740	2855	2950	3060	3190	3335	3500	
	395	505	655	810	870	925	995	1060	1125	1190	1245	1305	1375	1440	1530	1620				
	440	560	730	900	965	1030	1105	1180	1250	1320	1385	1450	1525	1600	1700	<b>1800</b>				
	580	725	925	1135	1240	1330	1405	1490	1580	1670	1755	1840	1915	2000	2085	2175	2285	2395	2520	

PRESSURE																				
psi	7	11	17	23	26	28	31	34	37	40	43	46	48	51	54	57	60	63	67	
bar	0,5	0,8	1,2	1,6	1,8	2	2,2	2,4	2,6	2,8	3	3,2	3,4	3,6	3,8	4	4,2	4,4	4,6	
MAX. LOAD kg																				
	565	720	925	1125	1215	1305	1415	1530	1620	1710	1785	1855	1935	2015	2130	2250				
	630	800	1030	1250	1350	1450	1575	1700	1800	1900	1980	2060	2150	2240	2370	<b>2500</b>				
	830	1035	1315	1590	1720	1850	1970	2105	2260	2405	2530	2645	2740	2855	2950	3060	3190	3335	3500	
	395	505	655	810	870	925	995	1060	1125	1190	1245	1305	1375	1440	1530	1620				
	440	560	730	900	965	1030	1105	1180	1250	1320	1385	1450	1525	1600	1700	<b>1800</b>				
	580	725	925	1135	1240	1330	1405	1490	1580	1670	1755	1840	1915	2000	2085	2175	2285	2395	2520	

PRESSURE																				
psi	7	12	17	23	26	29	32	35	38	41	43	46	49	52	55	58	61	64	67	
bar	0,5	0,8	1,2	1,6	1,8	2,0	2,2	2,4	2,6	2,8	3,0	3,2	3,4	3,6	3,8	4,0	4,2	4,4	4,6	
MAX. LOAD kg																				
	730	925	1190	1440	1555	1665	1785	1910	2045	2185	2255	2320	2460	2610	2725	2835				
	810	1030	1320	1600	1725	1850	1985	2120	2275	2430	2505	2575	2735	2900	3025	<b>3150</b>				
	1065	1335	1690	2035	2205	2370	2520	2670	2835	3005	3195	3385	3465	3585	3720	3925	4100	4260	4410	
	515	655	855	1010	1085	1155	1255	1350	1460	1575	1620	1665	1760	1855	1935	2015				
	575	730	950	1120	1205	1285	1390	1500	1625	1750	1805	1850	1955	2060	2150	<b>2240</b>				
	755	945	1205	1445	1545	1655	1750	1865	1995	2125	2280	2435	2495	2580	2665	2795	2915	3030	3135	

PRESSURE																						
psi	7	12	14	17	20	23	26	29	32	35	38	41	42	43	46	49	51	52	54	55	58	59
bar	0,5	0,8	1,0	1,2	1,4	1,6	1,8	2,0	2,2	2,4	2,6	2,8	2,9	3,0	3,2	3,4	3,5	3,6	3,7	3,8	4,0	4,1
MAX. LOAD kg																						
	770	980	1120	1260	1395	1530	1665	1800	1935	2070												
	855	1090	1245	1400	1550	1700	1850	2000	2150	<b>2300</b>												
	1130	1410	1600	1790	1980	2160	2340	2525	2710	2890	3075	3255										
	550	695	800	900	985	1060	1160	1260	1370	1485												
	610	775	885	1000	1090	1180	1290	1400	1525	<b>1650</b>												
	800	1005	1140	1275	1415	1520	1625	1760	1895	2035	2190	2335										

## Implement standard - AW305 - AF302 - T452 - T306 - AW309

X-ply tires for transport equipment



SIZE	LI/SS	New tire		Tire in service		SLR mm	RC mm	Rim	Type/Tube	Speed Km/h
		SW mm	OD mm	SW max mm	OD max mm					
380/55-17 AW305	138A8 ⊕→	384	845	410	880	355	2521	13.00	TL 15.0/55-17	Free Rolling
	126A8 ⊕									378
										10
										Driving wheel
										50
										40
										10

SIZE	LI/SS	New tire		Tire in service		SLR mm	RC mm	Rim	Type/Tube	Speed Km/h
		SW mm	OD mm	SW max mm	OD max mm					
380/55-17 AW309	138A8 ⊕→	384	845	410	880	355	2521	13.00	TL 15.0/55-17	Free Rolling
	126A8 ⊕									378
										10
										Driving wheel
										50
										40
										10

SIZE	LI/SS	New tire		Tire in service		SLR mm	RC mm	Rim	Type/Tube	Speed Km/h
		SW mm	OD mm	SW max mm	OD max mm					
420/55-17 T452	143A8 ⊕→	416	897	451	926	382	2606	13.00	TL	Free Rolling
	131A8 ⊕									
										40
										10
										Driving wheel
										50
										40
										10

SIZE	LI/SS	New tire		Tire in service		SLR mm	RC mm	Rim	Type/Tube	Speed Km/h
		SW mm	OD mm	SW max mm	OD max mm					
480/45-17 AW305	146A8 ⊕→	478	868	517	894	369	2582	16.00	TL 19.0/45-17 500/50-17	Free Rolling
	134A8 ⊕									390
										40
										10
										Driving wheel
										50
										40
										10

SIZE	LI/SS	New tire		Tire in service		SLR mm	RC mm	Rim	Type/Tube	Speed Km/h
		SW mm	OD mm	SW max mm	OD max mm					
480/45-17 AW309	150A8 ⊕→	480	860	517	894	365	2510	16.00	TL	Free Rolling
	138A8 ⊕									380
										40
										10
										Driving wheel
										50
										40
										10

PRESSURE																					
psi	7	12	14	17	20	23	26	29	32	35	38	41	43	46	49	51	52	54	55	58	59
bar	0,5	0,8	1,0	1,2	1,4	1,6	1,8	2,0	2,2	2,4	2,6	2,8	3,0	3,2	3,4	3,5	3,6	3,7	3,8	4,0	4,1
MAX. LOAD kg																					
	690	880	1000	1125	1260	1395	1510	1620	1735	1855	1990	2125									
	765	975	1115	1250	1400	1550	1675	1800	1930	2060	2210	<b>2360</b>									
	1010	1265	1430	1600	1765	1950	2135	2295	2445	2600	2755	2915	3100	3285							
	490	620	715	810	895	980	1055	1125	1215	1305	1415	1530									
	540	690	795	900	995	1090	1170	1250	1350	1450	1575	<b>1700</b>									
	715	895	1020	1145	1275	1390	1500	1610	1705	1810	1935	2055	2210	2370							

PRESSURE																					
psi	7	12	14	17	20	23	26	29	32	35	38	41	43	46	49	51	52	54	55	58	59
bar	0,5	0,8	1,0	1,2	1,4	1,6	1,8	2,0	2,2	2,4	2,6	2,8	3,0	3,2	3,4	3,5	3,6	3,7	3,8	4,0	4,1
MAX. LOAD kg																					
	690	880	1000	1125	1260	1395	1510	1620	1735	1855	1990	2125									
	765	975	1115	1250	1400	1550	1675	1800	1930	2060	2210	<b>2360</b>									
	1010	1265	1430	1600	1765	1950	2135	2295	2445	2600	2755	2915	3100	3285							
	490	620	715	810	895	980	1055	1125	1215	1305	1415	1530									
	540	690	795	900	995	1090	1170	1250	1350	1450	1575	<b>1700</b>									
	715	895	1020	1145	1275	1390	1500	1610	1705	1810	1935	2055	2210	2370							

PRESSURE						
psi	12	17	23	29	35	40
bar	0,8	1,2	1,6	2,0	2,4	2,8
MAX. LOAD kg						
	1030	1325	1620	1865	2160	1865
	1145	1470	1800	2070	2400	<b>2725</b>
	1600	2060	2520	2900	3355	2900
	735	950	1160	1335	1545	1755
	820	1055	1285	1480	1715	<b>1950</b>
	1145	1475	1800	2075	2400	2730

PRESSURE																					
psi	7	12	17	23	26	29	32	35	38	41	43	46	49	52	54	55	58	59			
bar	0,5	0,8	1,2	1,6	1,8	2,0	2,2	2,4	2,6	2,8	3,0	3,2	3,4	3,6	3,7	3,8	4,0	4,1			
MAX. LOAD kg																					
	835	1060	1350	1665	1790	1910	2075	2250	2385	2520	2615	2700									
	930	1180	1500	1850	1985	2120	2310	2500	2650	2800	2905	<b>3000</b>									
	1220	1530	1925	2335	2550	2735	2890	3085	3320	3540	3720	3900	4015	4165	4220						
	600	765	955	1155	1255	1350	1485	1620	1710	1800	1855	1910									
	670	850	1060	1285	1395	1500	1650	1800	1900	2000	2065	<b>2120</b>									
	880	1100	1375	1635	1770	1905	2035	2190	2380	2550	2670	2785	2855	2955	2980						

PRESSURE																					
psi	7	12	17	23	26	29	32	35	38	41	43	46	49	52	54	55	58	59			
bar	0,5	0,8	1,2	1,6	1,8	2,0	2,2	2,4	2,6	2,8	3,0	3,2	3,4	3,6	3,7	3,8	4,0	4,1			
MAX. LOAD kg																					
	835	1060	1350	1665	1790	1910	2075	2250	2385	2520	2615	2700	2855	3015							
	930	1180	1500	1850	1985	2120	2310	2500	2650	2800	2905	3000	3175	<b>3350</b>							
	1220	1530	1925	2335	2550	2735	2890	3085	3320	3540	3720	3900	4015	4165	4220	4325	4545	4650			
	600	765	955	1155	1255	1350	1485	1620	1710	1800	1855	1910	2015	2125							
	670	850	1060	1285	1395	1500	1650	1800	1900	2000	2065	2120	2240	<b>2360</b>							
	880	1100	1375	1635	1770	1905	2035	2190	2380	2550	2670	2785	2855	2955	2980	3055	3205	3275			

## Implement standard - AW305 - AF302 - T452 - T306 - AW309

X-ply tires for transport equipment



SIZE	LI/SS	New tire		Tire in service		SLR mm	RC mm	Rim	Type/Tube	Speed Km/h
		SW mm	OD mm	SW max mm	OD max mm					
500/50-17 AW309	149A8 ⊕→	495	945	543	968	408	2766	16.00	TL	Free Rolling
	137A8 ⊕									50
										10
										Driving wheel
										50
										40
										10

SIZE	LI/SS	New tire		Tire in service		SLR mm	RC mm	Rim	Type/Tube	Speed Km/h
		SW mm	OD mm	SW max mm	OD max mm					
520/50-17 T306	159A8 ⊕→	516	952	557	988	404	2820	16.00	TL	Free Rolling
	147A8 ⊕									50
										10
						421	2855			Driving wheel
										50
										40
										10

SIZE	LI/SS	New tire		Tire in service		SLR mm	RC mm	Rim	Type/Tube	Speed Km/h
		SW mm	OD mm	SW max mm	OD max mm					
500/55-20 AW309	150A8 ⊕→	510	1055	537	1080	455	3160	16.00	TL	Free Rolling
	138A8 ⊕									50
										10
						470	3175			Driving wheel
										50
										40
										10

## INCHES SIZES

SIZE	LI/SS	New tire		Tire in service		SLR mm	RC mm	Rim	Type/Tube	Speed Km/h
		SW mm	OD mm	SW max mm	OD max mm					
10.0/80-12 AW305	8 PR ⊕→	268	716	277	730	314	2138	9.00	TL/TL 8.50-12 10.0/80-12	Free Rolling
	8 PR ⊕									50
										10
										Driving wheel
										50
										40
										10

SIZE	LI/SS	New tire		Tire in service		SLR mm	RC mm	Rim	Type/Tube	Speed Km/h
		SW mm	OD mm	SW max mm	OD max mm					
10.0/80-12 AW305	10 PR ⊕→	268	716	277	730	314	2138	9.00	TL 8.50-12 10.0/80-12	Free Rolling
	10 PR ⊕									50
										10
										Driving wheel
										50
										40
										10

PRESSURE																	
psi	7	12	17	23	26	28	31	34	37	40	43	46	48	51	54	57	59
bar	0,5	0,8	1,2	1,6	1,8	2,0	2,2	2,4	2,6	2,8	3,0	3,2	3,4	3,6	3,8	4,0	4,1
MAX. LOAD kg																	
	990	1260	1620	1960	2110	2250	2430	2610	2770	2925							
	1100	1400	1800	2180	2345	2500	2700	2900	3075	<b>3250</b>							
	1450	1815	2300	2775	3005	3220	3410	3620	3865	4105	4320	4525					
	705	900	1125	1395	1510	1620	1735	1855	1965	2070							
	785	1000	1250	1550	1675	1800	1930	2060	2180	<b>2300</b>							
	1035	1295	1620	1950	2135	2295	2445	2600	2755	2915	3060	3205					

PRESSURE																	
psi	7	12	17	23	29	32	35	38	41	43	46	49	52	55	58	59	
bar	0,5	0,8	1,2	1,6	2,0	2,2	2,4	2,6	2,8	3,0	3,2	3,4	3,6	3,8	4,0	4,1	
MAX. LOAD kg																	
	1095	1395	1800	2185	2520	2720	2925	3105	3285	3445	3600	3770	3940				
	1220	1550	2000	2430	2800	3025	3250	3450	3650	3825	4000	4190	<b>4375</b>				
	1605	2010	2555	3090	3595	3815	4055	4330	4600	4845	5085	5295	5525	5740	5965	6075	
	770	980	1260	1575	1800	1935	2070	2195	2315	2420	2520	2645	2770				
	855	1090	1400	1750	2000	2150	2300	2440	2575	2690	2800	2940	<b>3075</b>				
	1130	1410	1790	2195	2585	2730	2890	3075	3255	3425	3585	3720	3875	4020	4185	4270	

PRESSURE																
psi	7	11	14	17	20	23	26	28	31	34	37	40	43	46	49	51
bar	0,5	0,8	1,0	1,2	1,4	1,6	1,8	2,0	2,2	2,4	2,6	2,8	3,0	3,2	3,4	3,5
MAX. LOAD kg																
	1130	1440	1645	1855	2055	2250	2430	2610	2815	3015						
	1255	1600	1830	2060	2280	2500	2700	2900	3125	<b>3350</b>						
	1655	2075	2350	2635	2910	3180	3445	3705	3945	4195	4470	4745				
	790	1010	1155	1305	1460	1620	1740	1855	1990	2125						
	880	1120	1285	1450	1625	1800	1935	2060	2210	<b>2360</b>						
	1160	1450	1650	1845	2050	2265	2480	2660	2810	2975	3155	3340				

## INCHES SIZES

PRESSURE																		
psi	7	12	14	17	20	23	26	29	32	35	38	41	43	45	46	49	52	55
bar	0,5	0,8	1,0	1,2	1,4	1,6	1,8	2,0	2,2	2,4	2,6	2,8	3,0	3,1	3,2	3,4	3,6	3,8
MAX. LOAD kg																		
	385	505	575	640	700	755	810	865	915	965	1010	1055	1095	1115				
	425	560	640	710	780	840	900	960	1015	1070	1120	1170	1215	<b>1240</b>				
	550	720	825	915	1005	1085	1160	1240	1310	1380	1445	1510	1565	1600				
	270	355	405	450	490	530	565	605	640	670	705	740	765	785				
	300	395	450	500	545	590	630	670	710	745	785	820	850	<b>870</b>				
	385	510	580	645	705	760	815	865	915	960	1015	1060	1095	1120				

PRESSURE																		
psi	7	12	14	17	20	23	26	29	32	35	38	41	43	46	49	52	55	57
bar	0,5	0,8	1,0	1,2	1,4	1,6	1,8	2,0	2,2	2,4	2,6	2,8	3,0	3,2	3,4	3,6	3,8	3,9
MAX. LOAD kg																		
	385	505	570	640	700	750	805	860	910	955	1000	1045	1090	1130	1170	1210	1250	1270
	425	560	635	710	775	835	895	955	1010	1060	1110	1160	1210	1255	1300	1345	1390	<b>1410</b>
	550	720	820	915	1000	1075	1155	1230	1305	1365	1430	1495	1560	1620	1675	1735	1795	1820
	265	350	400	445	485	525	565	605	635	670	700	735	760	790	820	845	875	885
	295	390	445	495	540	585	630	670	705	745	780	815	845	880	910	940	970	<b>985</b>
	380	505	575	640	695	755	815	865	910	960	1005	1050	1090	1135	1175	1215	1250	1270

For technical notes about pressure tables please refer to page 260.

### Implement standard - AW305 - AF302 - T452 - T306 - AW309

X-ply tires for transport equipment



# T404



Specially designed for grass and sensitive ground conditions. Its soft carcass design, tread pattern and low ground pressure avoid track formation and provide very low soil compaction.

This tire is also flexible for both soft and hard surfaces.

SIZE	New tire		Tire in service				Rim	Type	Speed Km/h	PRESSURE	
	SW mm	OD mm	SW mm	OD mm	SLR mm	RC mm				psi	bar
400/55-17.5 108A8 <b>T404</b>	400	870	420	892	410	2640	AG11.75	TL	50		
									40		
									25		
									10		

According to availability

SIZE	New tire		Tire in service				Rim	Type	Speed Km/h	PRESSURE	
	SW mm	OD mm	SW mm	OD mm	SLR mm	RC mm				psi	bar
400/55-22.5 111A8 <b>T404</b>	400	1000	420	1021	455	3000	AG11.75	TL	50		
									40		
									25		
									10		

SIZE	New tire		Tire in service				Rim	Type	Speed Km/h	PRESSURE	
	SW mm	OD mm	SW mm	OD mm	SLR mm	RC mm				psi	bar
600/60-30.5 142A8 <b>T404</b>	610	1500	630	1536	660	4360	AG20.00	TL	50		
									40		
									25		
									10		

## SIZE

**400/55-17.5 108A8 T404**

**400/55-22.5 111A8 T404**

**600/60-30.5 142A8 T404**

6 0,4	7 0,5	9 0,6	10 0,7	12 0,8	13 0,9	14 1,0	16 1,1	17 1,2	19 1,3	20 1,4
505	555	605	655	705	755	805	855	900		
560	615	670	725	780	835	890	945	<b>1000</b>		
670	735	800	865	930	995	1060	1125	1190		
710	775	845	915	985	1055	1125	1195	1260	1330	1400

6 0,4	7 0,5	9 0,6	10 0,7	12 0,8	13 0,9	14 1,0	16 1,1	17 1,2	19 1,3	20 1,4
550	605	660	715	770	820	875	930	985		
615	675	735	795	855	915	975	1035	<b>1090</b>		
730	800	870	945	1015	1085	1155	1230	1300		
770	845	925	1000	1075	1150	1225	1300	1375	1450	1530

6 0,4	7 0,5	9 0,6	10 0,7	12 0,8	13 0,9	14 1,0	16 1,1	17 1,2	19 1,3	20 1,4
1340	1470	1600	1730	1865	1995	2125	2255	2385		
1485	1630	1780	1925	2070	2215	2360	2505	<b>2650</b>		
1770	1940	2115	2290	2460	2635	2810	2985	3155		
1870	2055	2240	2425	2605	2790	2975	3160	3340	3525	3710

For technical notes about pressure tables please refer to page 260.

### Twin Garden Tractor: T404

X-ply tire for crop processing and green area equipment



# Light service tires

A large range of tires from 4" to 15" in rim diameter in different sizes and tread designs. These tires can be used

in farming, industrial and green area applications. Trelleborg offers a complete wheel solution.

## DRIVER



Green area tire for professional use.

## GARDENER



Green area tire for hobby machines.

## T49



High Speed tire with high shoulder profile.

## T63



Farming tire with traction pattern.

## T94



Industry tire with combined pattern.

## T310



Farming tire increasing efficiency during working operations due to its optimized groove depth and a smoother shape

## T411



Combined pattern for green area and farming.

## T412



Combined pattern for green area and farming.

## T413



Combined pattern for green area and farming.

## T415



Tire for small compact machines used for digging, drilling and loading.

## T421



Farming tire for ploughing and for mini loader.

## T430



Tire for agriculture and green areas with rounded shoulder profile for small dumpers and mini loaders

## T446



Farming tire with easy rolling pattern.

## T448



Farming tire with extra strong tread and easy rolling pattern.

## T462



Farming tire with traction pattern.

## T463



Combined tire for farming and green area.

## T501



High speed tire with easy rolling pattern.

## T510



Farming tire with easy rolling pattern.

## T513



Farming tire with extra good sidewall stability.

## T521



Smooth pattern tire for green area.



### T522



Industry, farming and green area tire with smooth pattern.

### T523



High Speed or industry tire with high shoulder.

### T528



Tire especially made for snow machines.

### T530



Industry tire with good grip and low roll resistance.

### T533



High Speed tire with combined pattern.

### T536



Farming tire with combined pattern.

### T537



Combined tire for green area, farming and industry.

### T539



Combined tire for green area, farming, industry or high speed service.

### T550



Skid Steer tire with good grip and comfort.

### T559 Turf Grip



Combined tire for green area, farming and industry.

### T560 ICE



For detachable chairlifts. Designed to perfectly work at very low temperature.

### T570



Skid Steer tire with good grip and comfort and long lifespan.

### T690



High Speed tire with high shoulder.

### T991



Industry and farming tire with rounded shoulder.

### HIGH GRIP



Tire for green areas with good grip.

### TRACTION



Farming tire with good grip.

#### Light service tires

X-ply tires for crop processing and green area equipment



## TIRES 4"

SIZE	PR/LI	Tread pattern	Main range of use	Rim size	Permitted rims	OD mm +/-1,5%	SW mm +/-2%	Max. air pressure bar	Max. load kg	Speed (km/h)	RC mm +/-2,5%
3.00-4	4	T991	Farming	2.10	2.5	260	88	3,5	105	30	772

### PRESSURE

psi	<b>7 12 14 17 20 23 26 29 32 35 38 41 43 46 51 55 61 64 67</b>
bar	<b>0,5 0,8 1,0 1,2 1,4 1,6 1,8 2,0 2,2 2,4 2,6 2,8 3,0 3,2 3,5 3,8 4,2 4,4 4,6</b>

### MAX. LOAD kg

40 FR	30 40 45 50 55 60 65 70 72 75 80 82 85 90 95
<b>30 FR</b>	35 45 50 55 60 65 70 75 80 85 90 92 95 100 <b>105</b>
10 FR	45 60 65 70 75 85 90 95 105 110 115 117 125 130 135
40 DrW	23 25 30 35 40 42 45 50 52 55 57 60 65 67 70
<b>30 DrW</b>	25 30 35 40 45 47 50 55 57 60 62 65 70 72 <b>75</b>
10 DrW	30 40 45 50 60 62 65 70 72 75 80 85 90 92 95
10C	40 45 55 65 70 75 80 85 90 95 100 105 110 115 120 123 127 130 135

SIZE	PR/LI	Tread pattern	Main range of use	Rim size	Permitted rims	OD mm +/-1,5%	SW mm +/-2%	Max. air pressure bar	Max. load kg	Speed (km/h)	RC mm +/-2,5%
3.00-4	6	T991	Farming	2.10	2.5	260	88	5,0	135	30	772

### PRESSURE

psi	<b>7 14 19 25 29 33 39 43 48 54 58 62 68 72</b>
bar	<b>0,5 1,0 1,3 1,7 2,0 2,3 2,7 3,0 3,3 3,7 4,0 4,3 4,7 5,0</b>

### MAX. LOAD kg

40 FR	30 50 55 65 70 75 85 90 95 105 110 115 117 120
<b>30 FR</b>	35 55 60 70 80 85 95 100 105 115 120 125 130 <b>135</b>
10 FR	45 70 75 90 105 110 125 130 135 150 155 160 170 175
40 DrW	20 30 40 45 50 55 60 65 70 72 75 77 80 85
<b>30 DrW</b>	25 35 45 50 55 60 65 70 75 80 85 87 90 <b>95</b>
10 DrW	30 45 60 65 70 75 85 90 95 105 110 112 114 115

SIZE	PR/LI	Tread pattern	Main range of use	Rim size	Permitted rims	OD mm +/-1,5%	SW mm +/-2%	Max. air pressure bar	Max. load kg	Speed (km/h)	RC mm +/-2,5%
3.00-4	6	T530	Industrial	2.10	2.5	252	83	6,0	200	25	751

### PRESSURE

psi	<b>14 22 29 36 43 51 58 65 72 80 87</b>
bar	<b>1,0 1,5 2,0 2,5 3,0 3,5 4,0 4,5 5,0 5,5 6,0</b>

### MAX. LOAD kg

50	60 75 90 100 115 120 135 145 150 160 170
40	60 80 95 105 120 130 140 150 160 170 180
<b>25</b>	70 90 105 120 135 145 160 170 180 190 <b>200</b>
10	90 115 135 155 175 190 210 220 235 245 260

SIZE	PR/LI	Tread pattern	Main range of use	Rim size	Permitted rims	OD mm +/-1,5%	SW mm +/-2%	Max. air pressure bar	Max. load kg	Speed (km/h)	RC mm +/-2,5%											
<b>4.00-4</b>	6	<b>T991</b>	Farming	2.50C	3.00	312	113	4,25	190	30	927											
<b>PRESSURE</b>																						
<b>psi</b>				<b>7</b>	<b>12</b>	<b>14</b>	<b>17</b>	<b>20</b>	<b>23</b>	<b>26</b>	<b>29</b>	<b>32</b>	<b>35</b>	<b>38</b>	<b>41</b>	<b>43</b>	<b>46</b>	<b>49</b>	<b>52</b>	<b>55</b>	<b>58</b>	<b>62</b>
<b>bar</b>				<b>0,5</b>	<b>0,8</b>	<b>1,0</b>	<b>1,2</b>	<b>1,4</b>	<b>1,6</b>	<b>1,8</b>	<b>2,0</b>	<b>2,2</b>	<b>2,4</b>	<b>2,6</b>	<b>2,8</b>	<b>3,0</b>	<b>3,2</b>	<b>3,4</b>	<b>3,6</b>	<b>3,8</b>	<b>4,0</b>	<b>4,2</b>
<b>MAX. LOAD kg</b>																						
40 FR				50	65	70	80	90	95	105	110	115	120	130	135	140	145	150	155	160	165	170
<b>30 FR</b>				55	70	80	90	100	105	115	120	130	135	145	150	155	160	165	170	180	185	<b>190</b>
10 FR				70	90	105	115	130	135	150	155	170	175	185	195	200	205	215	220	230	240	245
40 DrW				35	45	50	60	65	70	72	75	80	85	90	95	100	105	107	110	115	117	120
<b>30 DrW</b>				40	50	55	65	70	75	80	85	90	95	100	105	110	115	117	120	125	130	<b>135</b>
10 DrW				50	65	70	85	90	95	105	110	115	125	130	135	140	150	152	155	160	170	175

SIZE	PR/LI	Tread pattern	Main range of use	Rim size	Permitted rims	OD mm +/-1,5%	SW mm +/-2%	Max. air pressure bar	Max. load kg	Speed (km/h)	RC mm +/-2,5%					
<b>4.10/3.50-4</b>	6	<b>T539</b>	Industrial	2.10		272	89	6,9	210	25	808					
<b>PRESSURE</b>																
<b>psi</b>				<b>14</b>	<b>22</b>	<b>29</b>	<b>36</b>	<b>43</b>	<b>51</b>	<b>58</b>	<b>65</b>	<b>72</b>	<b>80</b>	<b>87</b>	<b>94</b>	<b>100</b>
<b>bar</b>				<b>1,0</b>	<b>1,5</b>	<b>2,0</b>	<b>2,5</b>	<b>3,0</b>	<b>3,5</b>	<b>4,0</b>	<b>4,5</b>	<b>5,0</b>	<b>5,5</b>	<b>6,0</b>	<b>6,5</b>	<b>6,9</b>
<b>MAX. LOAD kg</b>																
50				60	70	85	95	110	120	130	140	145	155	165	170	175
40				65	75	90	100	115	125	140	145	155	165	175	180	185
<b>25</b>				70	85	100	115	130	140	155	165	175	185	195	205	<b>210</b>
10				90	110	130	150	170	180	200	215	230	240	255	265	275

SIZE	PR/LI	Tread pattern	Main range of use	Rim size	Permitted rims	OD mm +/-1,5%	SW mm +/-2%	Max. air pressure bar	Max. load kg	Speed (km/h)	RC mm +/-2,5%				
<b>4.10-4</b>	4	<b>T510</b>	Farming	2.10C	3.25A	276	104	2,8	165	30	820				
<b>PRESSURE</b>															
<b>psi</b>				<b>7</b>	<b>12</b>	<b>14</b>	<b>17</b>	<b>20</b>	<b>23</b>	<b>26</b>	<b>29</b>	<b>32</b>	<b>35</b>	<b>38</b>	<b>41</b>
<b>bar</b>				<b>0,5</b>	<b>0,8</b>	<b>1,0</b>	<b>1,2</b>	<b>1,4</b>	<b>1,6</b>	<b>1,8</b>	<b>2,0</b>	<b>2,2</b>	<b>2,4</b>	<b>2,6</b>	<b>2,8</b>
<b>MAX. LOAD kg</b>															
40				55	70	80	90	100	110	115	120	130	135	145	150
<b>30</b>				60	80	90	100	110	120	125	135	145	150	160	<b>165</b>
10				75	105	115	130	140	155	160	175	185	195	205	215

SIZE	PR/LI	Tread pattern	Main range of use	Rim size	Permitted rims	OD mm +/-1,5%	SW mm +/-2%	Max. air pressure bar	Max. load kg	Speed (km/h)	RC mm +/-2,5%			
<b>11x4.00-4</b>	2	<b>T537S TL</b>	Green Area	2.75A	3.25A	262	101	1,5	100	25	778			
<b>PRESSURE</b>														
<b>psi</b>				<b>7</b>	<b>9</b>	<b>10</b>	<b>12</b>	<b>13</b>	<b>14</b>	<b>16</b>	<b>17</b>	<b>19</b>	<b>20</b>	<b>22</b>
<b>bar</b>				<b>0,5</b>	<b>0,6</b>	<b>0,7</b>	<b>0,8</b>	<b>0,9</b>	<b>1,0</b>	<b>1,1</b>	<b>1,2</b>	<b>1,3</b>	<b>1,4</b>	<b>1,5</b>
<b>MAX. LOAD kg</b>														
40				45	50	55	60	65	67	70	75	80	85	90
<b>25</b>				50	55	65	70	75	77	80	85	90	95	<b>100</b>
15				55	70	75	80	85	87	90	95	105	110	115
10				60	65	80	85	90	92	95	105	110	115	120

## Light service tires

X-ply tires for crop processing and green area equipment



SIZE	PR/LI	Tread pattern	Main range of use	Rim size	Permitted rims	OD mm +/-1,5%	SW mm +/-2%	Max. air pressure bar	Max. load kg	Speed (km/h)	RC mm +/-2,5%
<b>100/100-4</b>	60A8/48A8	<b>T539</b>	Industrial	2.5		304	98	6,0	250	40	908

#### PRESSURE

psi	<b>12 17 23 29 35 41 46 52 58 61 64 67 70 72 75 78 81 84 87</b>
bar	<b>0,8 1,2 1,6 2,0 2,4 2,8 3,2 3,6 4,0 4,2 4,4 4,6 4,8 5,0 5,2 5,4 5,6 5,8 6,0</b>

#### MAX. LOAD kg

50 FR	65 85 100 120 135 155 165 185 200 203 207 210 212 215 217 220 222 223 225
<b>40 FR</b>	75 95 110 130 150 170 185 205 220 225 230 233 235 235 237 240 245 247 <b>250</b>
10 FR	95 120 145 165 190 210 235 255 280 290 305 315 317 320 322 325 330 332 335
50 DrW	45 60 70 85 95 105 115 130 140 145 147 150 152 153 154 155 156 158 160
<b>40 DrW</b>	50 65 80 95 105 120 130 145 160 162 165 167 170 172 173 175 177 178 <b>180</b>
10 DrW	65 85 100 120 135 150 165 180 195 205 215 225 227 230 235 237 238 239 240

## TIRES 6"

SIZE	PR/LI	Tread pattern	Main range of use	Rim size	Permitted rims	OD mm +/-1,5%	SW mm +/-2%	Max. air pressure bar	Max. load kg	Speed (km/h)	RC mm +/-2,5%
<b>3.50-6</b>	4	<b>T510</b>	Farming	2.50A	2.50C	341	100	3,0	165	30	1013

#### PRESSURE

psi	<b>7 12 14 17 20 23 26 29 32 35 38 41 43</b>
bar	<b>0,5 0,8 1,0 1,2 1,4 1,6 1,8 2,0 2,2 2,4 2,6 2,8 3,0</b>

#### MAX. LOAD kg

40	55 70 75 85 95 105 110 115 125 130 135 145 150
<b>30</b>	60 75 85 95 105 115 120 130 140 145 150 160 <b>165</b>
10	75 95 110 125 135 150 155 170 180 185 195 205 215

SIZE	PR/LI	Tread pattern	Main range of use	Rim size	Permitted rims	OD mm +/-1,5%	SW mm +/-2%	Max. air pressure bar	Max. load kg	Speed (km/h)	RC mm +/-2,5%
<b>4.00-6</b>	6	<b>T991</b>	Farming	2.50A		358	108	4,3	250	30	1063

#### PRESSURE

psi	<b>14 17 20 23 26 29 32 35 38 41 43 46 49 52 55 58 61 62</b>
bar	<b>1,0 1,2 1,4 1,6 1,8 2,0 2,2 2,4 2,6 2,8 3,0 3,2 3,4 3,6 3,8 4,0 4,2 4,3</b>

#### MAX. LOAD kg

40 FR	95 110 115 125 135 145 155 160 165 175 185 190 200 205 210 215 220 225
<b>30 FR</b>	105 120 130 140 150 160 170 180 185 195 205 210 220 225 235 240 245 <b>250</b>
10 FR	135 155 170 180 195 205 220 230 240 250 265 270 285 290 305 310 315 325
40 DrW	70 75 80 90 95 100 110 115 117 120 125 130 140 145 150 155 157 160
<b>30 DrW</b>	75 85 90 100 105 110 120 125 130 135 140 145 155 160 165 170 172 <b>175</b>
10 DrW	95 110 115 130 135 140 155 160 170 175 180 185 200 205 215 220 222 225

SIZE	PR/LI	Tread pattern	Main range of use	Rim size	Permitted rims	OD mm +/-1,5%	SW mm +/-2%	Max. air pressure bar	Max. load kg	Speed (km/h)	RC mm +/-2,5%	
<b>4.10/3.50-6</b>	57J	<b>T533 HS</b>	High Speed	2.50A-6		320	94	4,5	230	100	950	
<b>PRESSURE</b>												
<b>psi</b>				<b>7</b>	<b>15</b>	<b>22</b>	<b>29</b>	<b>36</b>	<b>44</b>	<b>51</b>	<b>58</b>	<b>65</b>
<b>bar</b>				<b>0,5</b>	<b>1</b>	<b>1,5</b>	<b>2</b>	<b>2,5</b>	<b>3</b>	<b>3,5</b>	<b>4</b>	<b>4,5</b>
<b>MAX. LOAD kg</b>												
100				65	95	120	145	165	180	200	215	<b>230</b>
<b>80</b>				68	100	125	150	170	185	210	225	240
60				70	105	130	160	180	200	220	235	255
40				75	110	140	165	190	205	230	245	265
<b>30</b>				80	120	150	180	205	225	250	270	<b>290</b>
20				100	145	180	220	250	270	300	325	345
10				115	170	215	260	295	325	360	385	415

SIZE	PR/LI	Tread pattern	Main range of use	Rim size	Permitted rims	OD mm +/-1,5%	SW mm +/-2%	Max. air pressure bar	Max. load kg	Speed (km/h)	RC mm +/-2,5%
<b>13x5.00-6</b>	2	<b>GARDENER</b>	Green Area	3.50		325	120	1,4	132	30	962

SIZE	PR/LI	Tread pattern	Main range of use	Rim size	Permitted rims	OD mm +/-1,5%	SW mm +/-2%	Max. air pressure bar	Max. load kg	Speed (km/h)	RC mm +/-2,5%
<b>13x5.00-6</b>	4	<b>T539 TL</b>	Green Area	3.50A		322	117	2,8	200	30	956
<b>PRESSURE</b>											
<b>psi</b>				<b>12</b>	<b>17</b>	<b>23</b>		<b>29</b>	<b>35</b>	<b>41</b>	
<b>bar</b>				<b>0,8</b>	<b>1,2</b>	<b>1,6</b>		<b>2,0</b>	<b>2,4</b>	<b>2,8</b>	
<b>MAX. LOAD kg</b>											
40				75	95	120		135	160	180	
35				80	105	125		145	165	190	
<b>30</b>				85	110	130		150	175	<b>200</b>	
25				90	115	140		165	190	215	
20				95	125	150		175	200	230	
15				100	130	160		185	215	240	
10				110	140	170		195	225	260	
0				140	180	220		250	290	330	

SIZE	PR/LI	Tread pattern	Main range of use	Rim size	Permitted rims	OD mm +/-1,5%	SW mm +/-2%	Max. air pressure bar	Max. load kg	Speed (km/h)	RC mm +/-2,5%
<b>13x5.00-6</b>	6	<b>T539 TL</b>	Industrial	3.50A		320	122	4,1	250	30	989
<b>PRESSURE</b>											
<b>psi</b>				<b>12</b>	<b>23</b>	<b>29</b>	<b>35</b>	<b>41</b>	<b>46</b>	<b>52</b>	<b>59</b>
<b>bar</b>				<b>0,8</b>	<b>1,6</b>	<b>2,0</b>	<b>2,4</b>	<b>2,8</b>	<b>3,2</b>	<b>3,6</b>	<b>4,1</b>
<b>MAX. LOAD kg</b>											
40				70	115	135	155	175	195	205	225
35				75	120	140	160	185	210	215	240
<b>30</b>				80	130	150	170	195	220	230	<b>250</b>
25				85	135	160	180	205	225	245	270
20				90	145	170	195	220	235	260	285
15				95	155	180	205	235	250	275	305
10				105	165	190	220	250	270	295	325
0				130	210	245	280	320	340	375	415

### Light service tires

X-ply tires for crop processing and green area equipment



SIZE	PR/LI	Tread pattern	Main range of use	Rim size	Permitted rims	OD mm +/-1,5%	SW mm +/-2%	Max. air pressure bar	Max. load kg	Speed (km/h)	RC mm +/-2,5%
13x5.00-6	4	T510 TL	Farming	3.50A		326	119	2,8	200	30	968

**PRESSURE**

psi			<b>12</b>	<b>17</b>	<b>23</b>	<b>29</b>	<b>35</b>	<b>41</b>
bar			<b>0,8</b>	<b>1,2</b>	<b>1,6</b>	<b>2,0</b>	<b>2,4</b>	<b>2,8</b>

**MAX. LOAD kg**

40			75	95	120	135	160	180
35			80	105	125	145	165	190
<b>30</b>			85	110	130	150	175	<b>200</b>
25			90	115	140	165	190	215
20			95	125	150	175	200	230
15			100	130	160	185	215	240
10			110	140	170	195	225	260
0			140	180	220	250	290	330

SIZE	PR/LI	Tread pattern	Main range of use	Rim size	Permitted rims	OD mm +/-1,5%	SW mm +/-2%	Max. air pressure bar	Max. load kg	Speed (km/h)	RC mm +/-2,5%
13x5.00-6	6	T510	Farming	3.50A		326	119	4,1	250	30	955

**PRESSURE**

psi			<b>12</b>	<b>23</b>	<b>29</b>	<b>35</b>	<b>41</b>	<b>46</b>	<b>52</b>	<b>59</b>
bar			<b>0,8</b>	<b>1,6</b>	<b>2,0</b>	<b>2,4</b>	<b>2,8</b>	<b>3,2</b>	<b>3,6</b>	<b>4,1</b>

**MAX. LOAD kg**

40			70	115	135	155	175	195	205	225
35			75	120	140	160	185	210	215	240
<b>30</b>			80	130	150	170	195	220	230	<b>250</b>
25			85	135	160	180	205	225	245	270
20			90	145	170	195	220	235	260	285
15			95	155	180	205	235	250	275	305
10			105	165	190	220	250	270	295	325
0			130	210	245	280	320	340	375	415

SIZE	PR/LI	Tread pattern	Main range of use	Rim size	Permitted rims	OD mm +/-1,5%	SW mm +/-2%	Max. air pressure bar	Max. load kg	Speed (km/h)	RC mm +/-2,5%
15x6.00-6	2	GARDENER TL	Green Area	4.50		363	163	1,0	165	30	1070

SIZE	PR/LI	Tread pattern	Main range of use	Rim size	Permitted rims	OD mm +/-1,5%	SW mm +/-2%	Max. air pressure bar	Max. load kg	Speed (km/h)	RC mm +/-2,5%
15x6.00-6	4	T539 Grip TL	Green Area/Farming	4.50A-6		370	161	2,1	257	30	1099

**PRESSURE**

psi			<b>7</b>	<b>12</b>	<b>14</b>	<b>17</b>	<b>20</b>	<b>23</b>	<b>26</b>	<b>30</b>
bar			<b>0,5</b>	<b>0,8</b>	<b>1,0</b>	<b>1,2</b>	<b>1,4</b>	<b>1,6</b>	<b>1,8</b>	<b>2,1</b>

**MAX. LOAD kg**

40 FR			100	130	150	165	185	200	210	230
<b>30 FR</b>			110	145	165	185	205	220	235	<b>257</b>
10 FR			140	185	215	240	265	285	305	330
40 DrW			70	90	105	115	125	140	150	160
<b>30 DrW</b>			80	100	115	130	140	155	165	<b>180</b>
10 DrW			105	130	150	170	180	200	215	230

SIZE	PR/LI	Tread pattern	Main range of use	Rim size	Permitted rims	OD mm +/-1,5%	SW mm +/-2%	Max. air pressure bar	Max. load kg	Speed (km/h)	RC mm +/-2,5%
15x6.00-6	4	T510 TL	Farming	4.50A-6		368	160	2,1	257	30	1093
<b>PRESSURE</b>											
psi				<b>7</b>	<b>12</b>	<b>14</b>	<b>17</b>	<b>20</b>	<b>23</b>	<b>26</b>	<b>29</b>
bar				<b>0,5</b>	<b>0,8</b>	<b>1,0</b>	<b>1,2</b>	<b>1,4</b>	<b>1,6</b>	<b>1,8</b>	<b>2,0</b>
<b>MAX. LOAD kg</b>											
40				100	130	150	165	185	200	210	230
<b>30</b>				110	145	165	185	205	200	235	<b>257</b>
10				140	185	215	240	265	285	305	330

SIZE	PR/LI	Tread pattern	Main range of use	Rim size	Permitted rims	OD mm +/-1,5%	SW mm +/-2%	Max. air pressure bar	Max. load kg	Speed (km/h)	RC mm +/-2,5%									
15x6.00-6	6	T510 TT	Farming	4.50A-6		366	162	3,8	335	30	1087									
<b>PRESSURE</b>																				
psi				<b>7</b>	<b>12</b>	<b>14</b>	<b>17</b>	<b>20</b>	<b>23</b>	<b>26</b>	<b>29</b>	<b>32</b>	<b>35</b>	<b>38</b>	<b>41</b>	<b>44</b>	<b>46</b>	<b>49</b>	<b>52</b>	<b>55</b>
bar				<b>0,5</b>	<b>0,8</b>	<b>1,0</b>	<b>1,2</b>	<b>1,4</b>	<b>1,6</b>	<b>1,8</b>	<b>2,0</b>	<b>2,2</b>	<b>2,4</b>	<b>2,6</b>	<b>2,8</b>	<b>3</b>	<b>3,2</b>	<b>3,4</b>	<b>3,6</b>	<b>3,8</b>
<b>MAX. LOAD kg</b>																				
40				90	120	140	155	165	180	195	205	220	230	245	250	260	275	285	295	300
<b>30</b>				100	135	155	170	185	200	215	<b>230</b>	245	255	270	280	290	305	315	325	335
10				130	175	200	220	240	260	275	295	315	330	350	360	375	395	405	420	430

SIZE	PR/LI	Tread pattern	Main range of use	Rim size	Permitted rims	OD mm +/-1,5%	SW mm +/-2%	Max. air pressure bar	Max. load kg	Speed (km/h)	RC mm +/-2,5%
100/65-6	24A8	T539 Grip TL	Green Area	3.00A		286	96	1,6	90	40	835
<b>PRESSURE</b>											
psi				<b>7</b>	<b>12</b>	<b>14</b>	<b>17</b>	<b>20</b>	<b>23</b>	<b>25</b>	<b>26</b>
bar				<b>0,5</b>	<b>0,8</b>	<b>1,0</b>	<b>1,2</b>	<b>1,4</b>	<b>1,6</b>	<b>1,7</b>	<b>1,8</b>
<b>MAX. LOAD kg</b>											
50 FR				40	50	60	65	75	80		
<b>40 FR</b>				45	60	65	75	80	<b>90</b>		
10 FR				60	75	85	95	105	115	120	125
50 DrW						20	45	50	55		
<b>40 DrW</b>						25	50	55	<b>65</b>		
10 DrW						15	35	75	80	83	85

SIZE	PR/LI	Tread pattern	Main range of use	Rim size	Permitted rims	OD mm +/-1,5%	SW mm +/-2%	Max. air pressure bar	Max. load kg	Speed (km/h)	RC mm +/-2,5%				
100/85-6	46	T513	Farming	2.50A-6	2.50C-6	325	105	2,8	165	30	1004				
<b>PRESSURE</b>															
psi				<b>7</b>	<b>12</b>	<b>14</b>	<b>17</b>	<b>20</b>	<b>23</b>	<b>26</b>	<b>29</b>	<b>32</b>	<b>35</b>	<b>38</b>	<b>41</b>
bar				<b>0,5</b>	<b>0,8</b>	<b>1,0</b>	<b>1,2</b>	<b>1,4</b>	<b>1,6</b>	<b>1,8</b>	<b>2,0</b>	<b>2,2</b>	<b>2,4</b>	<b>2,6</b>	<b>2,8</b>
<b>MAX. LOAD kg</b>															
40 FR				55	70	85	95	105	115	115	125	135	140	150	155
<b>30 FR</b>				60	80	95	105	115	125	130	140	150	155	165	<b>170</b>
10 FR				75	105	125	135	150	160	170	180	195	200	215	220
40 DrW				40	50	60	65	70	75	80	90	95	100	105	110
<b>30 DrW</b>				45	55	65	70	80	85	90	100	105	110	115	<b>118</b>
10 DrW				60	70	85	90	105	110	115	130	135	140	150	155

## Light service tires

X-ply tires for crop processing and green area equipment



SIZE	PR/LI	Tread pattern	Main range of use	Rim size	Permitted rims	OD mm +/-1,5%	SW mm +/-2%	Max. air pressure bar	Max. load kg	Speed (km/h)	RC mm +/-2,5%
140-6	6	T539	Farming	4.50A		328	137	4,3	260	30	974

**PRESSURE**

psi	<b>12</b>	<b>14</b>	<b>22</b>	<b>29</b>	<b>36</b>	<b>43</b>	<b>46</b>	<b>49</b>	<b>52</b>	<b>55</b>	<b>58</b>	<b>62</b>
bar	<b>0,8</b>	<b>1,0</b>	<b>1,5</b>	<b>2,0</b>	<b>2,5</b>	<b>3,0</b>	<b>3,2</b>	<b>3,4</b>	<b>3,6</b>	<b>3,8</b>	<b>4,0</b>	<b>4,3</b>

**MAX. LOAD kg**

40 FR	85	100	125	150	170	190	200	205	210	215	225	235
<b>30 FR</b>	95	110	140	165	190	210	220	225	235	240	250	<b>260</b>
10 FR	125	140	180	215	245	270	285	290	305	310	325	335
40 DrW	65	70	90	105	120	130	140	145	150	155	158	160
<b>30 DrW</b>	70	80	100	115	135	145	155	160	165	170	175	<b>180</b>
10 DrW	90	105	130	150	175	185	200	205	215	220	225	230

SIZE	PR/LI	Tread pattern	Main range of use	Rim size	Permitted rims	OD mm +/-1,5%	SW mm +/-2%	Max. air pressure bar	Max. load kg	Speed (km/h)	RC mm +/-2,5%
140-6	10	T510	Industrial	4.50A		340	143	9,5	780	25	1004

**PRESSURE**

psi	<b>14</b>	<b>22</b>	<b>29</b>	<b>36</b>	<b>43</b>	<b>51</b>	<b>58</b>	<b>65</b>	<b>72</b>	<b>80</b>	<b>87</b>	<b>94</b>	<b>101</b>	<b>109</b>	<b>116</b>	<b>123</b>	<b>130</b>	<b>138</b>
bar	<b>1,0</b>	<b>1,5</b>	<b>2,0</b>	<b>2,5</b>	<b>3,0</b>	<b>3,5</b>	<b>4,0</b>	<b>4,5</b>	<b>5,0</b>	<b>5,5</b>	<b>6,0</b>	<b>6,5</b>	<b>7,0</b>	<b>7,5</b>	<b>8,0</b>	<b>8,5</b>	<b>9,0</b>	<b>9,5</b>

**MAX. LOAD kg**

50	175	225	265	300	330	365	395	425	450	475	500	525	545	570	590	615	635	655
40	185	235	280	315	350	385	420	450	475	505	530	555	580	605	625	650	670	695
<b>25</b>	210	265	315	355	395	435	470	505	535	565	595	625	650	680	705	730	755	<b>780</b>
10	275	345	410	460	515	565	610	655	695	735	775	815	845	885	915	950	980	1015



## TIRES 8"

SIZE	PR/LI	Tread pattern	Main range of use	Rim size	Permitted rims	OD mm +/-1,5%	SW mm +/-2%	Max. air pressure bar	Max. load kg	Speed (km/h)	RC mm +/-2,5%
<b>3.00-8</b>	2	<b>T539 Grey</b>	Industrial	2.50A	2.10	358	86	2,4	140	25	1063

### PRESSURE

<b>psi</b>	<b>7</b>	<b>12</b>	<b>14</b>	<b>17</b>	<b>20</b>	<b>23</b>	<b>26</b>	<b>29</b>	<b>32</b>	<b>35</b>
<b>bar</b>	<b>0,5</b>	<b>0,8</b>	<b>1,0</b>	<b>1,2</b>	<b>1,4</b>	<b>1,6</b>	<b>1,8</b>	<b>2,0</b>	<b>2,2</b>	<b>2,4</b>

### MAX. LOAD kg

50	45	65	70	80	85	90	100	105	115	120
40	50	70	75	85	90	100	105	110	120	125
<b>25</b>	55	75	85	95	100	110	120	125	135	<b>140</b>
10	70	100	110	125	130	145	155	165	175	180

SIZE	PR/LI	Tread pattern	Main range of use	Rim size	Permitted rims	OD mm +/-1,5%	SW mm +/-2%	Max. air pressure bar	Max. load kg	Speed (km/h)	RC mm +/-2,5%
<b>3.50-8</b>	4	<b>T510</b>	Farming	2.50A	2.10	392	101	2,8	190	30	1164

### PRESSURE

<b>psi</b>	<b>7</b>	<b>12</b>	<b>14</b>	<b>17</b>	<b>20</b>	<b>23</b>	<b>26</b>	<b>29</b>	<b>32</b>	<b>35</b>	<b>38</b>	<b>41</b>
<b>bar</b>	<b>0,5</b>	<b>0,8</b>	<b>1,0</b>	<b>1,2</b>	<b>1,4</b>	<b>1,6</b>	<b>1,8</b>	<b>2,0</b>	<b>2,2</b>	<b>2,4</b>	<b>2,6</b>	<b>2,8</b>

### MAX. LOAD kg

40	65	80	95	105	115	120	130	140	150	160	165	170
<b>30</b>	70	90	105	115	125	135	145	155	165	175	180	<b>190</b>
10	90	115	135	150	160	175	185	200	215	225	230	245

SIZE	PR/LI	Tread pattern	Main range of use	Rim size	Permitted rims	OD mm +/-1,5%	SW mm +/-2%	Max. air pressure bar	Max. load kg	Speed (km/h)	RC mm +/-2,5%
<b>3.50-8</b>	4	<b>T513</b>	Farming	2.50A	2.10	399	98	2,8	190	30	1185

### PRESSURE

<b>psi</b>	<b>7</b>	<b>12</b>	<b>14</b>	<b>17</b>	<b>20</b>	<b>23</b>	<b>26</b>	<b>29</b>	<b>32</b>	<b>35</b>	<b>38</b>	<b>41</b>
<b>bar</b>	<b>0,5</b>	<b>0,8</b>	<b>1,0</b>	<b>1,2</b>	<b>1,4</b>	<b>1,6</b>	<b>1,8</b>	<b>2,0</b>	<b>2,2</b>	<b>2,4</b>	<b>2,6</b>	<b>2,8</b>

### MAX. LOAD kg

40	65	80	95	105	115	120	130	140	150	160	165	170
<b>30</b>	70	90	105	115	125	135	145	155	165	175	180	<b>190</b>
10	90	115	135	150	160	175	185	200	215	225	230	245

SIZE	PR/LI	Tread pattern	Main range of use	Rim size	Permitted rims	OD mm +/-1,5%	SW mm +/-2%	Max. air pressure bar	Max. load kg	Speed (km/h)	RC mm +/-2,5%
<b>3.50-8</b>	56J	<b>T501 HS</b>	High Speed	2.50A-8	2.1-8	500	255	4,3	224	100	1167
<b>4.00-8</b>	4	<b>T63 TL</b>	Farming	2.50A	3.00	427	106	2,8	225	30	1277
	4	<b>T510</b>	Farming	2.50A	3.00	425	114	2,8	225	30	1236
	4	<b>T513</b>	Farming	2.50A	3.00	426	107	2,8	225	30	1271
	6	<b>T991</b>	Farming	2.50A	3.00	416	105	4,3	290	30	1233
	6	<b>T522</b>	Farming	2.50A	3.00	430	110	4,3	290	30	1265

## Light service tires

X-ply tires for crop processing and green area equipment



SIZE	PR/LI	Tread pattern	Main range of use	Rim size	Permitted rims	OD mm +/-1,5%	SW mm +/-2%	Max. air pressure bar	Max. load kg	Speed (km/h)	RC mm +/-2,5%
<b>4.00-8</b>	8	<b>T523</b>	Industrial	2.50	3.00/3.75	418	123	9,0	670	25	1240

**PRESSURE**

<b>psi</b>	<b>14 22 29 36 43 51 58 65 72 80 87 94 101 109 116 123 130</b>
<b>bar</b>	<b>1,0 1,5 2,0 2,5 3,0 3,5 4,0 4,5 5,0 5,5 6,0 6,5 7,0 7,5 8,0 8,5 9,0</b>

**MAX. LOAD kg**

50	155 195 235 265 295 325 350 375 400 420 445 465 485 505 525 545 565
40	165 210 250 280 310 345 370 395 425 445 470 495 515 535 555 580 595
<b>25</b>	185 235 280 315 350 385 415 445 475 500 530 555 580 600 625 650 <b>670</b>
10	240 305 365 410 455 500 540 580 620 650 690 720 755 780 815 845 870

SIZE	PR/LI	Tread pattern	Main range of use	Rim size	Permitted rims	OD mm +/-1,5%	SW mm +/-2%	Max. air pressure bar	Max. load kg	Speed (km/h)	RC mm +/-2,5%
<b>4.00-8</b>	71J	<b>T49 HS</b>	High Speed	2.50A-8	3.00-8	423	121	6,3	345	100	1241

SIZE	PR/LI	Tread pattern	Main range of use	Rim size	Permitted rims	OD mm +/-1,5%	SW mm +/-2%	Max. air pressure bar	Max. load kg	Speed (km/h)	RC mm +/-2,5%
<b>5.00-8</b>	6	<b>T522</b>	Farming	3.00		450	130	3,6	387	30	1337
<b>16x6.50-8</b>	4	<b>T539 Grip TL</b>	Green Area	5.375I	5.50A	406	166	1,9	280	30	1206
<b>16x6.50-8</b>	6	<b>T539</b>	Farming	5.375I-8	5.50A-8	410	174	3,0	365	30	1218

SIZE	PR/LI	Tread pattern	Main range of use	Rim size	Permitted rims	OD mm +/-1,5%	SW mm +/-2%	Max. air pressure bar	Max. load kg	Speed (km/h)	RC mm +/-2,5%
<b>16x6.50-8</b>	73A8	<b>T510</b>	Farming	5.375I	5.50A	413	173	3,0	325	40	1221

**PRESSURE**

<b>psi</b>	<b>7 12 17 23 29 32 35 38 41 44</b>
<b>bar</b>	<b>0,5 0,8 1,2 1,6 2,0 2,2 2,4 2,6 2,8 3,0</b>

**MAX. LOAD kg**

50	115 155 195 230 260 275 290 300 315 330
<b>40</b>	130 170 215 255 290 305 320 335 350 <b>365</b>
30	145 190 240 285 325 340 360 375 390 410
25	155 200 255 305 345 365 380 400 415 435
20	165 215 270 320 365 385 405 420 440 460
10	180 240 300 355 405 425 450 470 490 510

SIZE	PR/LI	Tread pattern	Main range of use	Rim size	Permitted rims	OD mm +/-1,5%	SW mm +/-2%	Max. air pressure bar	Max. load kg	Speed (km/h)	RC mm +/-2,5%
16x6.50-8	73A8	T310	Farming	5.375I	5.50A	413	173	3,0	325	40	1221

#### PRESSURE

psi	7	12	17	23	29	32	35	38	41	44
bar	0,5	0,8	1,2	1,6	2,0	2,2	2,4	2,6	2,8	3,0

#### MAX. LOAD kg

50	115	155	195	230	260	275	290	300	315	330
40	130	170	215	255	290	305	320	335	350	365
30	145	190	240	285	325	340	360	375	390	410
25	155	200	255	305	345	365	380	400	415	435
20	165	215	270	320	365	385	405	420	440	460
10	180	240	300	355	405	425	450	470	490	510

SIZE	PR/LI	Tread pattern	Main range of use	Rim size	Permitted rims	OD mm +/-1,5%	SW mm +/-2%	Max. air pressure bar	Max. load kg	Speed (km/h)	RC mm +/-2,5%
16x6.50-8	84	T310	Farming	5.375I	5.50A	406	172	5,1	500	40,5	1221

#### PRESSURE

psi	12	17	22	29	35	40	43	49	51	54	57	63	66	69	74
bar	0,8	1,2	1,6	2,0	2,4	2,8	3,0	3,4	3,6	3,8	4,0	4,4	4,6	4,8	5,1

#### MAX. LOAD kg

50	155	195	230	260	290	315	330	355	370	380	390	415	425	435	450
40	170	215	255	290	320	350	365	395	410	420	435	460	470	485	500
30	190	240	285	325	360	390	410	440	460	470	485	515	525	545	560
25	200	255	305	345	380	415	435	470	490	500	520	545	560	575	595
20	215	270	320	365	405	440	460	500	515	530	550	580	590	610	630
10	240	300	355	405	450	490	510	555	575	590	610	645	660	680	700

SIZE	PR/LI	Tread pattern	Main range of use	Rim size	Permitted rims	OD mm +/-1,5%	SW mm +/-2%	Max. air pressure bar	Max. load kg	Speed (km/h)	RC mm +/-2,5%
16x6.50-8	84A8/80B	T510	Green Area	5.375I	5.50A	406	172	5,1	500	40	1221
	2/49A6	GARDENER TL	Green Area	5.375		414	168	1,0	185	30	1221

SIZE	PR/LI	Tread pattern	Main range of use	Rim size	Permitted rims	OD mm +/-1,5%	SW mm +/-2%	Max. air pressure bar	Max. load kg	Speed (km/h)	RC mm +/-2,5%
16.5x6.50-8	64J	T539 HS	High Speed	5.375-8	5.50A-8	411	165	3,1	280	100	1224

#### PRESSURE

psi	7	12	15	22	30	36	44	45
bar	0,5	0,8	1	1,5	2,1	2,5	3	3,1

#### MAX. LOAD kg

10	170	225	260	335	405	440	495	505
20	145	190	220	280	340	370	415	420
30	120	155	180	230	280	305	345	350
40	110	145	165	215	260	280	315	320
60	105	140	160	205	250	270	305	310
80	100	130	150	190	235	255	285	290
100	95	125	145	185	225	245	275	280

## Light service tires

X-ply tires for crop processing and green area equipment



SIZE	PR/LI	Tread pattern	Main range of use	Rim size	Permitted rims	OD mm +/-1,5%	SW mm +/-2%	Max. air pressure bar	Max. load kg	Speed (km/h)	RC mm +/-2,5%
16.5x6.50-8	72J	T539 HS TL	High Speed	5.375I	5.50A	408	172	4,8	365	100	1212
16x7.50-8	4	T537 TL	Green Area	5.375	5.50A	430	180	2,1	335	30	1265

SIZE	PR/LI	Tread pattern	Main range of use	Rim size	Permitted rims	OD mm +/-1,5%	SW mm +/-2%	Max. air pressure bar	Max. load kg	Speed (km/h)	RC mm +/-2,5%
16x7.50-8	4/70A6	T539 TL	Green Area	5.375I	5.00A	420	179	1,8	335	30	1240

#### PRESSURE

psi	<b>7</b>	<b>12</b>	<b>14</b>	<b>17</b>	<b>20</b>	<b>23</b>	<b>26</b>
bar	<b>0,5</b>	<b>0,8</b>	<b>1</b>	<b>1,2</b>	<b>1,4</b>	<b>1,6</b>	<b>1,8</b>

#### MAX. LOAD kg

<b>40</b>	145	190	215	240	260	285	<b>300</b>
30	160	210	240	265	290	315	335
25	170	225	255	285	310	335	360
20	180	240	275	300	330	360	380
15	195	255	290	320	350	380	405
10	205	270	310	340	375	405	430

SIZE	PR/LI	Tread pattern	Main range of use	Rim size	Permitted rims	OD mm +/-1,5%	SW mm +/-2%	Max. air pressure bar	Max. load kg	Speed (km/h)	RC mm +/-2,5%
18x7.50-8	2	T539 TL	Green Area/Farming	5.50	6.00	464	184	0,9	243	30	1372
18x8.50-8	2/58A6	GARDENER TL	Green Area	7.00		455	214	0,7	236	30	1350

SIZE	PR/LI	Tread pattern	Main range of use	Rim size	Permitted rims	OD mm +/-1,5%	SW mm +/-2%	Max. air pressure bar	Max. load kg	Speed (km/h)	RC mm +/-2,5%
18x8.50-8	6	T539	Farming	7.00I	6.50	466	222	2,8	475	30	1384
	6	T510	Farming	7.00I	6.50	463	225	2,8	475	30	1384

SIZE	PR/LI	Tread pattern	Main range of use	Rim size	Permitted rims	OD mm +/-1,5%	SW mm +/-2%	Max. air pressure bar	Max. load kg	Speed (km/h)	RC mm +/-2,5%
18x8.50-8	4	T539 TL	Green Area/Farming	7.00I	6.50	472	222	1,5	375	30	1402

**PRESSURE**

<b>psi</b>	<b>12</b>	<b>14</b>	<b>17</b>	<b>20</b>	<b>22</b>
<b>bar</b>	<b>0,8</b>	<b>1,0</b>	<b>1,2</b>	<b>1,4</b>	<b>1,5</b>

**MAX. LOAD kg**

40	235	265	295	325	340
35	245	280	315	340	355
<b>30</b>	260	295	330	360	<b>375</b>
25	280	315	355	385	400
20	295	335	375	410	430
15	315	355	400	435	455
10	335	380	425	465	485

SIZE	PR/LI	Tread pattern	Main range of use	Rim size	Permitted rims	OD mm +/-1,5%	SW mm +/-2%	Max. air pressure bar	Max. load kg	Speed (km/h)	RC mm +/-2,5%
18x8.50-8	6	T510	Farming	7.00I	6.50	463	225	2,8	475	30	1384

SIZE	PR/LI	Tread pattern	Main range of use	Rim size	Permitted rims	OD mm +/-1,5%	SW mm +/-2%	Max. air pressure bar	Max. load kg	Speed (km/h)	RC mm +/-2,5%
18x8.50-8	6	T539	Farming	7.00I	6.50-8	466	222	2,8	475	30	1384

**PRESSURE**

<b>psi</b>	<b>12</b>	<b>15</b>	<b>17</b>	<b>20</b>	<b>23</b>	<b>26</b>	<b>29</b>	<b>32</b>	<b>35</b>	<b>38</b>	<b>41</b>
<b>bar</b>	<b>0,8</b>	<b>1,0</b>	<b>1,2</b>	<b>1,4</b>	<b>1,6</b>	<b>1,8</b>	<b>2,0</b>	<b>2,2</b>	<b>2,4</b>	<b>2,6</b>	<b>2,8</b>

**MAX. LOAD kg**

40	205	235	260	285	305	330	350	370	390	410	430
<b>30</b>	230	260	290	315	340	365	390	410	435	455	<b>475</b>
25	245	280	310	335	365	390	415	440	465	485	510
20	260	295	330	360	390	415	445	465	495	520	540
15	280	315	350	380	410	440	470	495	525	550	575
10	295	335	375	405	440	470	505	530	560	585	615

SIZE	PR/LI	Tread pattern	Main range of use	Rim size	Permitted rims	OD mm +/-1,5%	SW mm +/-2%	Max. air pressure bar	Max. load kg	Speed (km/h)	RC mm +/-2,5%
18x8.50-8	8PR	T415	Industrial	7.00I-8	6.50-8	450	213	3,2	580	30	1347

**PRESSURE**

<b>psi</b>	<b>12</b>	<b>15</b>	<b>17</b>	<b>20</b>	<b>23</b>	<b>26</b>	<b>29</b>	<b>32</b>	<b>35</b>	<b>37</b>	<b>40</b>	<b>43</b>	<b>46</b>
<b>bar</b>	<b>0,8</b>	<b>1</b>	<b>1,2</b>	<b>1,4</b>	<b>1,6</b>	<b>1,8</b>	<b>2</b>	<b>2,2</b>	<b>2,4</b>	<b>2,6</b>	<b>2,8</b>	<b>3</b>	<b>3,2</b>

**MAX. LOAD kg**

50	210	235	260	290	310	330	350	370	390	410	430	450	465
45	215	245	270	300	320	345	365	385	405	425	445	465	480
40	225	255	280	310	330	355	375	400	420	440	460	480	495
35	230	260	290	320	340	370	390	410	435	455	475	495	515
30	240	270	295	330	350	380	400	425	450	470	490	510	530
25	245	280	305	340	365	390	415	440	460	485	505	530	545
20	255	285	315	350	375	405	425	450	475	500	520	545	565
<b>15</b>	260	295	325	360	385	415	440	465	490	515	535	560	<b>580</b>

**Light service tires**

X-ply tires for crop processing and green area equipment



SIZE	PR/LI	Tread pattern	Main range of use	Rim size	Permitted rims	OD mm +/-1,5%	SW mm +/-2%	Max. air pressure bar	Max. load kg	Speed (km/h)	RC mm +/-2,5%
<b>18x8.50-8</b>	8	<b>T570 TL</b>	Skid Steer	7.00I		450	213	3,2	580	15	

**PRESSURE**

<b>psi</b>	<b>12</b>	<b>17</b>	<b>23</b>	<b>29</b>	<b>32</b>	<b>35</b>	<b>38</b>	<b>41</b>	<b>43</b>	<b>46</b>
<b>bar</b>	<b>0,8</b>	<b>1,2</b>	<b>1,6</b>	<b>2,0</b>	<b>2,2</b>	<b>2,4</b>	<b>2,6</b>	<b>2,8</b>	<b>3,0</b>	<b>3,2</b>

**MAX. LOAD kg**

40	220	275	325	375	395	415	440	455	475	495
30	235	295	345	395	420	440	465	480	505	520
25	245	310	365	420	440	465	490	510	530	550
20	255	320	375	430	455	480	505	525	550	570
<b>15</b>	260	325	385	440	465	490	515	535	560	<b>580</b>
10	310	385	460	525	555	585	615	635	665	690

SIZE	PR/LI	Tread pattern	Main range of use	Rim size	Permitted rims	OD mm +/-1,5%	SW mm +/-2%	Max. air pressure bar	Max. load kg	Speed (km/h)	RC mm +/-2,5%
<b>18x9.50-8</b>	4	<b>T521 GT TL</b>	Green Area	7.00I		455	240	1,7	470	25	1348

**PRESSURE**

<b>psi</b>	<b>7</b>	<b>12</b>	<b>14</b>	<b>17</b>	<b>20</b>	<b>23</b>	<b>25</b>
<b>bar</b>	<b>0,5</b>	<b>0,8</b>	<b>1,0</b>	<b>1,2</b>	<b>1,4</b>	<b>1,6</b>	<b>1,7</b>

**MAX. LOAD kg**

40	200	265	305	340	370	400	415
30	220	285	330	365	400	430	445
<b>25</b>	230	300	345	385	420	455	<b>470</b>
20	245	320	370	410	450	485	505
15	260	340	395	440	480	520	535
10	280	365	415	465	510	550	570
0	365	475	545	610	665	720	745

SIZE	PR/LI	Tread pattern	Main range of use	Rim size	Permitted rims	OD mm +/-1,5%	SW mm +/-2%	Max. air pressure bar	Max. load kg	Speed (km/h)	RC mm +/-2,5%
<b>18x9.50-8</b>	4/82A6	<b>DRIVER TL</b>	Professional	7.00		465	235	1,7	475	30	1347
<b>20x8.00-8</b>	4	<b>T539 TL</b>	Green Area	6.00		515	215	1,5	420	30	1517
<b>20x10.00-8</b>	2	<b>Gardener</b>	Green Area	7.00		500	255	0,7	345	30	1463

SIZE	PR/LI	Tread pattern	Main range of use	Rim size	Permitted rims	OD mm +/-1,5%	SW mm +/-2%	Max. air pressure bar	Max. load kg	Speed (km/h)	RC mm +/-2,5%
<b>20x10.00-8</b>	6	<b>T539</b>	Farming	8.50	8.00	529	264	2,4	670	30	1556
<b>PRESSURE</b>											
<b>psi</b>			<b>7</b>	<b>12</b>	<b>14</b>	<b>17</b>	<b>20</b>	<b>23</b>	<b>26</b>	<b>29</b>	<b>32</b>
<b>bar</b>			<b>0,5</b>	<b>0,8</b>	<b>1</b>	<b>1,2</b>	<b>1,4</b>	<b>1,6</b>	<b>1,8</b>	<b>2</b>	<b>2,2</b>
<b>MAX. LOAD kg</b>											
40			250	335	380	425	465	500	535	570	605
<b>30</b>			280	370	420	470	515	555	595	635	<b>670</b>
20			320	420	480	535	585	635	680	725	765
15			340	450	510	570	625	670	720	770	810
<b>10</b>			360	475	540	605	665	715	770	820	865

SIZE	PR/LI	Tread pattern	Main range of use	Rim size	Permitted rims	OD mm +/-1,5%	SW mm +/-2%	Max. air pressure bar	Max. load kg	Speed (km/h)	RC mm +/-2,5%
<b>170/60-8</b>	47A8/35A8	<b>HIGH GRIP TL</b>	Green Area	5.375		407	171	1,2	175	40	1195
<b>PRESSURE</b>											
<b>psi</b>			<b>7</b>	<b>12</b>	<b>14</b>	<b>17</b>	<b>20</b>				
<b>bar</b>			<b>0,5</b>	<b>0,8</b>	<b>1,0</b>	<b>1,2</b>	<b>1,4</b>				
<b>MAX. LOAD kg</b>											
50 FR			95	120	140	160					
<b>40 FR</b>			105	135	155	<b>175</b>					
10 FR			140	175	200	225	245				
50 DrW			70	90	100	110					
<b>40 DrW</b>			75	95	110	<b>120</b>					
10 DrW			100	125	140	155	170				

SIZE	PR/LI	Tread pattern	Main range of use	Rim size	Permitted rims	OD mm +/-1,5%	SW mm +/-2%	Max. air pressure bar	Max. load kg	Speed (km/h)	RC mm +/-2,5%
<b>190-8</b>	8	<b>T537</b>	Industrial	5.50	6.00	424	175	5,9	575	25	1265

## Light service tires

X-ply tires for crop processing and green area equipment



SIZE	PR/LI	Tread pattern	Main range of use	Rim size	Permitted rims	OD mm +/-1,5%	SW mm +/-2%	Max. air pressure bar	Max. load kg	Speed (km/h)	RC mm +/-2,5%			
<b>200/65-8</b>	59A8/47A8	<b>HIGH GRIP TL</b>	Green Area	5.375	6.50	455	205	1,2	243	40	1360			
<b>PRESSURE</b>														
<b>psi</b>			<b>7</b>	<b>12</b>	<b>14</b>	<b>17</b>	<b>20</b>	<b>23</b>	<b>26</b>	<b>28</b>	<b>31</b>	<b>34</b>	<b>37</b>	<b>40</b>
<b>bar</b>			<b>0,5</b>	<b>0,8</b>	<b>1,0</b>	<b>1,2</b>	<b>1,4</b>	<b>1,6</b>	<b>1,8</b>	<b>2</b>	<b>2,2</b>	<b>2,4</b>	<b>2,6</b>	<b>2,8</b>
<b>MAX. LOAD kg</b>														
50 FR			135	170	195	220	243	265	280	310	345	370	400	445
<b>40 FR</b>			150	190	215	243	265	280	310	345	370	400	445	475
10 FR			195	245	280	310	345	370	395	420	445	475	500	535
50 DrW			95	120	140	160	180	200	215	235	255	275	295	315
<b>40 DrW</b>			105	130	155	175	195	215	235	255	275	295	315	335
10 DrW			135	170	195	220	243	265	280	310	345	370	400	445

SIZE	PR/LI	Tread pattern	Main range of use	Rim size	Permitted rims	OD mm +/-1,5%	SW mm +/-2%	Max. air pressure bar	Max. load kg	Speed (km/h)	RC mm +/-2,5%			
<b>220/45-8</b>	70A8/58A8	<b>T510</b>	Farming	7.00I-8		410	220	2,4	335	40	1195			
<b>PRESSURE</b>														
<b>psi</b>			<b>7</b>	<b>12</b>	<b>14</b>	<b>17</b>	<b>20</b>	<b>23</b>	<b>26</b>	<b>28</b>	<b>31</b>	<b>34</b>	<b>37</b>	<b>40</b>
<b>bar</b>			<b>0,5</b>	<b>0,8</b>	<b>1,0</b>	<b>1,2</b>	<b>1,4</b>	<b>1,6</b>	<b>1,8</b>	<b>2</b>	<b>2,2</b>	<b>2,4</b>	<b>2,6</b>	<b>2,8</b>
<b>MAX. LOAD kg</b>														
50 FR			115	145	165	185	205	225	245	260	300	335	370	405
<b>40 FR</b>			125	160	185	205	230	250	270	290	315	335	355	375
10 FR			165	210	235	265	290	320	345	370	395	420	445	475
50 DrW			80	100	115	130	145	160	175	185	200	215	230	245
<b>40 DrW</b>			90	110	130	145	160	180	195	205	220	235	250	265
10 DrW			115	145	165	185	205	225	250	265	280	300	315	335

SIZE	PR/LI	Tread pattern	Main range of use	Rim size	Permitted rims	OD mm +/-1,5%	SW mm +/-2%	Max. air pressure bar	Max. load kg	Speed (km/h)	RC mm +/-2,5%			
<b>220/45-8</b>	70A8/58A8	<b>T310</b>	Farming	7.00I-8		410	220	2,4	335	40	1195			
<b>PRESSURE</b>														
<b>psi</b>			<b>7</b>	<b>12</b>	<b>14</b>	<b>17</b>	<b>20</b>	<b>23</b>	<b>26</b>	<b>28</b>	<b>31</b>	<b>34</b>	<b>37</b>	<b>40</b>
<b>bar</b>			<b>0,5</b>	<b>0,8</b>	<b>1,0</b>	<b>1,2</b>	<b>1,4</b>	<b>1,6</b>	<b>1,8</b>	<b>2</b>	<b>2,2</b>	<b>2,4</b>	<b>2,6</b>	<b>2,8</b>
<b>MAX. LOAD kg</b>														
50 FR			115	145	165	185	205	225	245	260	300	335	370	405
<b>40 FR</b>			125	160	185	205	230	250	270	290	315	335	355	375
10 FR			165	210	235	265	290	320	345	370	395	420	445	475
50 DrW			80	100	115	130	145	160	175	185	200	215	230	245
<b>40 DrW</b>			90	110	130	145	160	180	195	205	220	235	250	265
10 DrW			115	145	165	185	205	225	250	265	280	300	315	335



SIZE	PR/LI	Tread pattern	Main range of use	Rim size	Permitted rims	OD mm +/-1,5%	SW mm +/-2%	Max. air pressure bar	Max. load kg	Speed (km/h)	RC mm +/-2,5%	
<b>220/60-8</b>	74A8/62A8	<b>T463 PLUS</b>	Farming	7.00I-8	8.00-8	476	220	2,0	375	40	1392	
<b>PRESSURE</b>												
<b>psi</b>			<b>7</b>	<b>12</b>	<b>14</b>	<b>17</b>	<b>20</b>	<b>23</b>	<b>26</b>	<b>28</b>	<b>31</b>	<b>34</b>
<b>bar</b>			<b>0,5</b>	<b>0,8</b>	<b>1,0</b>	<b>1,2</b>	<b>1,4</b>	<b>1,6</b>	<b>1,8</b>	<b>2,0</b>	<b>2,2</b>	<b>2,4</b>
<b>MAX. LOAD kg</b>												
50 FR			145	185	210	240	265	295	315	340		
<b>40 FR</b>			160	205	235	265	295	325	350	<b>375</b>		
10 FR			215	265	305	340	375	410	445	480	510	525
50 DrW			105	130	150	170	190	205	225	240		
<b>40 DrW</b>			115	145	165	190	210	230	250	<b>265</b>		
10 DrW			150	190	215	240	270	295	315	340	360	370

SIZE	PR/LI	Tread pattern	Main range of use	Rim size	Permitted rims	OD mm +/-1,5%	SW mm +/-2%	Max. air pressure bar	Max. load kg	Speed (km/h)	RC mm +/-2,5%
<b>210/60-8</b>	83A8	<b>T415 TL</b>	Industrial	7.00	6.50	455	212	3,2	487	40	1347
<b>PRESSURE</b>											
<b>psi</b>			<b>12</b>	<b>17</b>	<b>23</b>	<b>29</b>	<b>35</b>	<b>41</b>	<b>46</b>		
<b>bar</b>			<b>0,8</b>	<b>1,2</b>	<b>1,6</b>	<b>2,0</b>	<b>2,4</b>	<b>2,8</b>	<b>3,2</b>		
<b>MAX. LOAD kg</b>											
50 FR			170	220	270	310	360	410	440		
<b>40 FR</b>			190	245	300	345	400	455	<b>487</b>		
30 FR			215	275	335	390	450	510	545		
10 FR			265	345	420	485	560	635	680		
50 DrW			120	155	195	220	255	290	310		
<b>40 DrW</b>			135	175	215	245	285	320	<b>345</b>		
30 DrW			150	195	240	275	315	360	385		
10 DrW			190	240	300	345	395	450	485		

SIZE	PR/LI	Tread pattern	Main range of use	Rim size	Permitted rims	OD mm +/-1,5%	SW mm +/-2%	Max. air pressure bar	Max. load kg	Speed (km/h)	RC mm +/-2,5%					
<b>220/60-8</b>	83	<b>T510</b>	Farming	7.00I		464	222	2,8	487	40	1382					
<b>PRESSURE</b>																
<b>psi</b>			<b>7</b>	<b>12</b>	<b>14</b>	<b>17</b>	<b>20</b>	<b>23</b>	<b>26</b>	<b>29</b>	<b>32</b>	<b>35</b>	<b>38</b>	<b>41</b>	<b>43</b>	<b>46</b>
<b>bar</b>			<b>0,5</b>	<b>0,8</b>	<b>1,0</b>	<b>1,2</b>	<b>1,4</b>	<b>1,6</b>	<b>1,8</b>	<b>2,0</b>	<b>2,2</b>	<b>2,4</b>	<b>2,6</b>	<b>2,8</b>	<b>3,0</b>	<b>3,2</b>
<b>MAX. LOAD kg</b>																
50 FR			145	185	210	240	265	295	315	340	365	395	415	440		
<b>40 FR</b>			160	205	235	265	295	325	350	375	405	435	460	<b>487</b>		
10 FR			215	265	305	340	375	410	445	480	510	545	580	620	650	680
50 DrW			105	130	150	170	190	205	225	240	255	275	295	310		
<b>40 DrW</b>			115	145	165	190	210	230	250	265	285	305	325	<b>345</b>		
10 DrW			150	190	215	240	270	295	315	340	360	385	410	435	460	480

## Light service tires

X-ply tires for crop processing and green area equipment



## TIRES 9"

SIZE	PR/LI	Tread pattern	Main range of use	Rim size	Permitted rims	OD mm +/-1,5%	SW mm +/-2%	Max. air pressure bar	Max. load kg	Speed (km/h)	RC mm +/-2,5%
6.00-9	6	T522	Farming	4.50	4.00E	560	174	3,0	500	30	1665

### PRESSURE

psi	<b>7</b>	<b>12</b>	<b>14</b>	<b>17</b>	<b>20</b>	<b>23</b>	<b>26</b>	<b>29</b>	<b>32</b>	<b>35</b>	<b>38</b>	<b>41</b>	<b>43</b>
bar	<b>0,5</b>	<b>0,8</b>	<b>1,0</b>	<b>1,2</b>	<b>1,4</b>	<b>1,6</b>	<b>1,8</b>	<b>2,0</b>	<b>2,2</b>	<b>2,4</b>	<b>2,6</b>	<b>2,8</b>	<b>3,0</b>

### MAX. LOAD kg

40 FR	160	205	240	265	290	310	335	355	375	395	415	430	450
<b>30 FR</b>	175	230	265	295	320	345	370	395	415	440	460	480	<b>500</b>
10 FR	225	295	340	380	415	445	475	510	535	570	595	620	645
40 DrW	115	145	165	185	205	215	235	250	260	275	290	300	315
<b>30 DrW</b>	125	160	185	205	225	240	260	275	290	305	320	335	<b>350</b>
10 DrW	160	205	240	265	290	310	335	355	375	395	415	430	450

SIZE	PR/LI	Tread pattern	Main range of use	Rim size	Permitted rims	OD mm +/-1,5%	SW mm +/-2%	Max. air pressure bar	Max. load kg	Speed (km/h)	RC mm +/-2,5%
6.00-9	10	T522	Farming	4.00E-9	4.50-9	564	164	5,0	670	30	1675

### PRESSURE

psi	<b>7</b>	<b>14</b>	<b>22</b>	<b>29</b>	<b>36</b>	<b>43</b>	<b>46</b>	<b>49</b>	<b>52</b>	<b>55</b>	<b>58</b>	<b>62</b>	<b>64</b>	<b>67</b>	<b>70</b>	<b>72</b>
bar	<b>0,5</b>	<b>1,0</b>	<b>1,5</b>	<b>2,0</b>	<b>2,5</b>	<b>3,0</b>	<b>3,2</b>	<b>3,4</b>	<b>3,6</b>	<b>3,8</b>	<b>4,0</b>	<b>4,2</b>	<b>4,4</b>	<b>4,6</b>	<b>4,8</b>	<b>5,0</b>

### MAX. LOAD kg

40 FR	160	240	295	355	400	450	465	480	500	515	530	545	560	575	590	605
<b>30 FR</b>	175	265	330	395	445	500	515	535	555	570	590	605	620	640	655	<b>670</b>
10 FR	225	340	425	510	575	645	665	690	715	735	760	780	800	825	845	865
40 DrW	115	165	205	250	285	315	325	340	345	360	370	385	390	400	415	425
<b>30 DrW</b>	125	185	230	275	315	350	360	375	385	400	410	425	435	445	460	<b>475</b>
10 DrW	160	240	295	355	405	450	465	485	495	515	530	550	560	575	595	605

SIZE	PR/LI	Tread pattern	Main range of use	Rim size	Permitted rims	OD mm +/-1,5%	SW mm +/-2%	Max. air pressure bar	Max. load kg	Speed (km/h)	RC mm +/-2,5%
6.00-9	10	T991	Farming	4.00E	4.50	542	182	5,0	670	30	1610
	99J	T523 HS	High Speed	4.00E	4.50	562	170	8,5	775	100	1669

## TIRES 10"

SIZE	PR/LI	Tread pattern	Main range of use	Rim size	Permitted rims	OD mm +/-1,5%	SW mm +/-2%	Max. air pressure bar	Max. load kg	Speed (km/h)	RC mm +/-2,5%
4.40-10	62J	T690 HS	High Speed	3.50-10	-	476	118	3,5	265	100	1414

SIZE	PR/LI	Tread pattern	Main range of use	Rim size	Permitted rims	OD mm +/-1,5%	SW mm +/-2%	Max. air pressure bar	Max. load kg	Speed (km/h)	RC mm +/-2,5%											
<b>5.0-10</b>	8	<b>T462 TL</b>	Farming	4.00	3.50	537	144	5,2	670	30	1571											
<b>PRESSURE</b>																						
<b>psi</b>				<b>12</b>	<b>14</b>	<b>19</b>	<b>23</b>	<b>29</b>	<b>33</b>	<b>38</b>	<b>43</b>	<b>48</b>	<b>52</b>	<b>58</b>	<b>62</b>	<b>67</b>	<b>72</b>	<b>75</b>	<b>81</b>	<b>87</b>	<b>93</b>	<b>99</b>
<b>bar</b>				<b>0,8</b>	<b>1,0</b>	<b>1,3</b>	<b>1,6</b>	<b>2,0</b>	<b>2,3</b>	<b>2,6</b>	<b>3,0</b>	<b>3,3</b>	<b>3,6</b>	<b>4,0</b>	<b>4,3</b>	<b>4,6</b>	<b>5,0</b>	<b>5,2</b>	<b>5,6</b>	<b>6,0</b>	<b>6,4</b>	<b>6,8</b>
<b>MAX. LOAD kg</b>																						
40 FR				205	230	270	300	345	375	400	435	465	485	520	540	565	590	605				
<b>30 FR</b>				225	255	300	335	385	415	445	485	515	540	575	600	625	655	<b>670</b>				
10 FR				290	330	385	430	495	535	575	625	665	695	740	775	805	845	865				
40 DrW				140	160	190	210	245	260	285	305	325	340	360	380	390	415	425				
<b>30 DrW</b>				155	180	210	235	270	290	315	340	360	380	400	420	435	460	<b>470</b>				
10 DrW				200	230	270	305	350	375	405	440	465	490	515	540	560	595	605				
10C				245	285	330	370	425	455	495	535	570	600	630	660	685	725	740	775	805	835	865

SIZE	PR/LI	Tread pattern	Main range of use	Rim size	Permitted rims	OD mm +/-1,5%	SW mm +/-2%	Max. air pressure bar	Max. load kg	Speed (km/h)	RC mm +/-2,5%							
<b>7.50-10</b>	12	<b>T991</b>	Farming	5.50F-10	6.00F-10	670	224	5,0	1075	30	1990							
<b>PRESSURE</b>																		
<b>psi</b>				<b>14</b>	<b>22</b>	<b>29</b>	<b>36</b>	<b>43</b>	<b>46</b>	<b>49</b>	<b>52</b>	<b>55</b>	<b>58</b>	<b>62</b>	<b>64</b>	<b>67</b>	<b>70</b>	<b>72</b>
<b>bar</b>				<b>1,0</b>	<b>1,5</b>	<b>2,0</b>	<b>2,5</b>	<b>3,0</b>	<b>3,2</b>	<b>3,4</b>	<b>3,6</b>	<b>3,8</b>	<b>4,0</b>	<b>4,2</b>	<b>4,4</b>	<b>4,6</b>	<b>4,8</b>	<b>5,0</b>
<b>MAX. LOAD kg</b>																		
40 FR				380	475	565	645	715	745	775	795	825	850	875	900	925	945	970
<b>30 FR</b>				420	530	630	715	795	830	860	885	915	945	970	1000	1025	1050	<b>1075</b>
10 FR				540	685	815	920	1025	1070	1110	1140	1180	1220	1250	1290	1320	1355	1385
40 DrW				265	335	395	450	505	520	540	560	575	595	610	630	645	660	680
<b>30 DrW</b>				295	370	440	500	560	580	600	620	640	660	680	700	715	735	<b>755</b>
10 DrW				380	475	570	645	720	750	775	800	825	850	875	905	920	950	975

SIZE	PR/LI	Tread pattern	Main range of use	Rim size	Permitted rims	OD mm +/-1,5%	SW mm +/-2%	Max. air pressure bar	Max. load kg	Speed (km/h)	RC mm +/-2,5%
<b>7.50-10</b>	14	<b>T523 TL</b>	Industrial	5.50F		668	225	9,0	2180	25	1984

SIZE	PR/LI	Tread pattern	Main range of use	Rim size	Permitted rims	OD mm +/-1,5%	SW mm +/-2%	Max. air pressure bar	Max. load kg	Speed (km/h)	RC mm +/-2,5%		
<b>18x8.50-10</b>	8	<b>T570 TL</b>	Skid Steer	7.00I		468	204	3,2	545	15	1391		
<b>PRESSURE</b>													
<b>psi</b>				<b>12</b>	<b>17</b>	<b>23</b>	<b>29</b>	<b>32</b>	<b>35</b>	<b>38</b>	<b>41</b>	<b>43</b>	<b>46</b>
<b>bar</b>				<b>0,8</b>	<b>1,2</b>	<b>1,6</b>	<b>2,0</b>	<b>2,2</b>	<b>2,4</b>	<b>2,6</b>	<b>2,8</b>	<b>3,0</b>	<b>3,2</b>
<b>MAX. LOAD kg</b>													
40				205	260	310	355	375	390	410	430	445	465
30				215	275	330	375	395	415	435	455	475	490
25				230	290	345	395	420	435	460	480	500	520
20				235	300	360	405	430	450	475	495	515	535
<b>15</b>				240	305	365	415	440	460	485	505	525	<b>545</b>
10				285	365	435	495	525	545	575	600	625	650

## Light service tires

X-ply tires for crop processing and green area equipment



SIZE	PR/LI	Tread pattern	Main range of use	Rim size	Permitted rims	OD mm +/-1,5%	SW mm +/-2%	Max. air pressure bar	Max. load kg	Speed (km/h)	RC mm +/-2,5%
20x8.00-10	4	T539 GT TL	Green Area	6.00I	7.00	512	204	1,7	412	30	1521

**PRESSURE**

psi	<b>12</b>	<b>14</b>	<b>17</b>	<b>20</b>	<b>23</b>	<b>25</b>
bar	<b>0,8</b>	<b>1,0</b>	<b>1,2</b>	<b>1,4</b>	<b>1,6</b>	<b>1,7</b>

**MAX. LOAD kg**

40	210	240	270	295	320	330
35	240	270	300	335	360	370
<b>30</b>	265	300	335	370	400	<b>412</b>
25	285	320	360	395	430	440
20	320	360	400	445	480	490
15	345	390	435	480	520	535
10	370	420	470	520	560	575

SIZE	PR/LI	Tread pattern	Main range of use	Rim size	Permitted rims	OD mm +/-1,5%	SW mm +/-2%	Max. air pressure bar	Max. load kg	Speed (km/h)	RC mm +/-2,5%
20x8.00-10	6	T539 TL	Farming	6.00I		505	204	2,9	585	30	1500

**PRESSURE**

psi	<b>12</b>	<b>14</b>	<b>17</b>	<b>20</b>	<b>23</b>	<b>26</b>	<b>29</b>	<b>32</b>	<b>35</b>	<b>38</b>	<b>41</b>	<b>42</b>	<b>43</b>	<b>46</b>	<b>49</b>	<b>52</b>	<b>55</b>
bar	<b>0,8</b>	<b>1,0</b>	<b>1,2</b>	<b>1,4</b>	<b>1,6</b>	<b>1,8</b>	<b>2,0</b>	<b>2,2</b>	<b>2,4</b>	<b>2,6</b>	<b>2,8</b>	<b>2,9</b>	<b>3,0</b>	<b>3,2</b>	<b>3,4</b>	<b>3,6</b>	<b>3,8</b>

**MAX. LOAD kg**

40 FR	250	285	315	340	375	400	425	450	475	495	520	525					
<b>30 FR</b>	275	315	350	380	415	445	470	500	525	550	575	<b>585</b>					
10 FR	355	405	450	490	535	575	605	645	675	710	740	755					
40 DrW	175	200	220	245	260	280	295	315	330	345	360	370					
<b>30 DrW</b>	195	220	245	270	290	310	330	350	365	385	400	<b>410</b>					
10 DrW	250	285	315	350	375	400	425	450	470	495	515	530					
10C	310	345	385	425	455	490	520	550	575	605	630	645	660	685	710	735	755

SIZE	PR/LI	Tread pattern	Main range of use	Rim size	Permitted rims	OD mm +/-1,5%	SW mm +/-2%	Max. air pressure bar	Max. load kg	Speed (km/h)	RC mm +/-2,5%
20x8.00-10	8	T570 TL	Skid Steer	6.00I		505	208	2,8	615	15	1532
20.5x8.00-10	10	T539 TL	Farming	7.00		525	208	4,0	825	30	1573
20x10.00-10	6	T539 TL	Farming	7.00	8.50	512	242	2,4	650	30	1533

SIZE	PR/LI	Tread pattern	Main range of use	Rim size	Permitted rims	OD mm +/-1,5%	SW mm +/-2%	Max. air pressure bar	Max. load kg	Speed (km/h)	RC mm +/-2,5%
110/100-10	8448/72A8	T560 ICETL	Ropeway	3.00B		474	110	5,0	500	40	1420

**PRESSURE**

psi	<b>12</b>	<b>17</b>	<b>23</b>	<b>26</b>	<b>29</b>	<b>32</b>	<b>35</b>	<b>38</b>	<b>41</b>	<b>43</b>	<b>46</b>	<b>49</b>	<b>52</b>	<b>55</b>	<b>58</b>	<b>62</b>	<b>67</b>	<b>72</b>	<b>75</b>	<b>84</b>
bar	<b>0,8</b>	<b>1,2</b>	<b>1,6</b>	<b>1,8</b>	<b>2,0</b>	<b>2,2</b>	<b>2,4</b>	<b>2,6</b>	<b>2,8</b>	<b>3,0</b>	<b>3,2</b>	<b>3,4</b>	<b>3,6</b>	<b>3,8</b>	<b>4,0</b>	<b>4,3</b>	<b>4,6</b>	<b>5,0</b>	<b>5,2</b>	<b>5,8</b>

**MAX. LOAD kg**

50 FR	135	175	210	230	245	265	285	305	330	340	350	365	385	400	415	430	440	450		
<b>40 FR</b>	150	195	235	255	270	295	315	340	365	375	385	405	425	445	460	475	490	<b>500</b>		
10 FR	195	250	300	325	350	370	395	420	445	475	510	520	540	555	580	615	645	665	680	705
50 DrW	95	120	155	165	175	190	200	215	230	240	245	255	270	280	295	300	310	320		
<b>40 DrW</b>	105	135	170	185	195	210	225	240	255	265	270	285	300	315	325	335	345	<b>355</b>		
10 DrW	140	175	215	235	250	265	280	300	315	335	360	365	380	390	410	435	455	470	480	500

SIZE	PR/LI	Tread pattern	Main range of use	Rim size	Permitted rims	OD mm +/-1,5%	SW mm +/-2%	Max. air pressure bar	Max. load kg	Speed (km/h)	RC mm +/-2,5%
<b>200/55-10</b>	95A8	<b>T430 TL</b>	Farming	6.00	5.50/7.00	487	190	4,0	690	40	1448

#### PRESSURE

psi	<b>12</b>	<b>17</b>	<b>23</b>	<b>29</b>	<b>35</b>	<b>41</b>	<b>46</b>	<b>52</b>	<b>58</b>
bar	<b>0,8</b>	<b>1,2</b>	<b>1,6</b>	<b>2,0</b>	<b>2,4</b>	<b>2,8</b>	<b>3,2</b>	<b>3,6</b>	<b>4,0</b>

#### MAX. LOAD kg

50 FR	200	260	320	370	430	475	520	565	620
<b>40 FR</b>	225	290	355	410	475	530	580	630	<b>690</b>
30 FR	250	325	400	460	530	595	650	705	775
10 FR	290	370	450	525	595	675	740	800	860
50 DrW	145	185	225	260	300	340	370	405	440
<b>40 DrW</b>	160	205	250	290	335	375	410	450	<b>485</b>
30 DrW	180	230	280	325	375	420	460	505	545
10 DrW	210	265	320	370	420	475	525	570	615

SIZE	PR/LI	Tread pattern	Main range of use	Rim size	Permitted rims	OD mm +/-1,5%	SW mm +/-2%	Max. air pressure bar	Max. load kg	Speed (km/h)	RC mm +/-2,5%
<b>250/50-10</b>	79A8/67A8	<b>HIGH GRIP TL</b>	Green Area	8.50		504	251	1,2	437	40	1515

### TIRES 12"

SIZE	PR/LI	Tread pattern	Main range of use	Rim size	Permitted rims	OD mm +/-1,5%	SW mm +/-2%	Max. air pressure bar	Max. load kg	Speed (km/h)	RC mm +/-2,5%
<b>6-12</b>	4	<b>T63 TL</b>	Farming	4.00E	5.00	582	146	2,75	230	30	1729
<b>10.0/75-12</b>	10	<b>T446 TL</b>	Farming	9.00	7.00	690	255	3,9	1325	30	2049

SIZE	PR/LI	Tread pattern	Main range of use	Rim size	Permitted rims	OD mm +/-1,5%	SW mm +/-2%	Max. air pressure bar	Max. load kg	Speed (km/h)	RC mm +/-2,5%
<b>23x8.50-12</b>	4	<b>T463 TL</b>	Farming	7.00	7JA	570	213	1,8	500	30	1699

#### PRESSURE

psi	<b>12</b>	<b>17</b>	<b>26</b>
bar	<b>0,8</b>	<b>1,2</b>	<b>1,8</b>

#### MAX. LOAD kg

40	288	369	450
35	304	390	475
<b>30</b>	320	410	<b>500</b>
25	342	439	535
20	365	467	570
15	387	496	605
10	413	529	645
0	528	677	825

### Light service tires

X-ply tires for crop processing and green area equipment



SIZE	PR/LI	Tread pattern	Main range of use	Rim size	Permitted rims	OD mm +/-1,5%	SW mm +/-2%	Max. air pressure bar	Max. load kg	Speed (km/h)	RC mm +/-2,5%
<b>23x8.50-12</b>	104	<b>T463 TL</b>	Farming	7.00	7JA-12	572	-	4,0	900	40	1718

**PRESSURE**

psi	<b>14</b>	<b>17</b>	<b>20</b>	<b>23</b>	<b>26</b>	<b>29</b>	<b>32</b>	<b>35</b>	<b>38</b>	<b>41</b>	<b>43</b>	<b>46</b>	<b>49</b>	<b>52</b>	<b>55</b>	<b>58</b>
bar	<b>1,0</b>	<b>1,2</b>	<b>1,4</b>	<b>1,6</b>	<b>1,8</b>	<b>2,0</b>	<b>2,2</b>	<b>2,4</b>	<b>2,6</b>	<b>2,8</b>	<b>3,0</b>	<b>3,2</b>	<b>3,4</b>	<b>3,6</b>	<b>3,8</b>	<b>4,0</b>

**MAX. LOAD kg**

40	400	445	485	525	565	600	635	670	700	730	760	790	820	845	875	<b>900</b>
30	450	500	545	590	635	670	710	750	785	820	850	885	920	945	980	1010
20	505	560	610	660	710	755	800	845	880	920	960	995	1035	1065	1105	1135
15	530	590	645	700	750	800	845	890	930	970	1010	1050	1090	1125	1165	1195
10	560	625	680	735	790	840	890	940	980	1020	1065	1105	1150	1185	1225	1260

SIZE	PR/LI	Tread pattern	Main range of use	Rim size	Permitted rims	OD mm +/-1,5%	SW mm +/-2%	Max. air pressure bar	Max. load kg	Speed (km/h)	RC mm +/-2,5%
<b>23x8.50-12</b>	6	<b>T550 TL</b>	Skid Steer	7.00I	7JA	589	211	3,4	820	10	1752

**PRESSURE**

psi	<b>12</b>	<b>14</b>	<b>17</b>	<b>20</b>	<b>23</b>	<b>26</b>	<b>29</b>	<b>32</b>	<b>35</b>	<b>38</b>	<b>41</b>	<b>43</b>	<b>46</b>	<b>49</b>
bar	<b>0,5</b>	<b>1,0</b>	<b>1,2</b>	<b>1,4</b>	<b>1,6</b>	<b>1,8</b>	<b>2,0</b>	<b>2,2</b>	<b>2,4</b>	<b>2,6</b>	<b>2,8</b>	<b>3,0</b>	<b>3,2</b>	<b>3,4</b>

**MAX. LOAD kg**

50	220	250	280	310	335	355	380	400	420	440	460	480	500	515
40	230	265	295	325	350	375	395	420	440	460	480	500	520	540
30	240	270	305	335	360	385	410	430	455	475	495	515	535	560
20	265	305	340	370	405	430	455	485	510	530	555	580	600	625
15	275	315	350	385	420	445	475	500	530	555	575	600	625	650
<b>10</b>	350	400	445	490	530	565	600	635	670	700	730	760	790	<b>820</b>
0	555	630	705	775	835	895	950	1005	1060	1105	1155	1200	1250	1295

SIZE	PR/LI	Tread pattern	Main range of use	Rim size	Permitted rims	OD mm +/-1,5%	SW mm +/-2%	Max. air pressure bar	Max. load kg	Speed (km/h)	RC mm +/-2,5%
<b>23x8.50-12</b>	10	<b>T539</b>	Farming	7.00I	7JA	568	212	4,0	900	30	1687

**PRESSURE**

psi	<b>14</b>	<b>17</b>	<b>20</b>	<b>23</b>	<b>26</b>	<b>29</b>	<b>32</b>	<b>35</b>	<b>38</b>	<b>41</b>	<b>43</b>	<b>46</b>	<b>49</b>	<b>52</b>	<b>55</b>	<b>58</b>
bar	<b>1,0</b>	<b>1,2</b>	<b>1,4</b>	<b>1,6</b>	<b>1,8</b>	<b>2,0</b>	<b>2,2</b>	<b>2,4</b>	<b>2,6</b>	<b>2,8</b>	<b>3,0</b>	<b>3,2</b>	<b>3,4</b>	<b>3,6</b>	<b>3,8</b>	<b>4,0</b>

**MAX. LOAD kg**

40	360	400	435	475	510	540	570	605	630	655	685	710	740	760	790	810
<b>30</b>	400	445	485	525	565	600	635	670	700	730	760	790	820	845	875	<b>900</b>
20	455	505	555	600	645	685	725	765	800	830	865	900	935	965	1000	1025
15	485	540	585	635	685	725	770	810	845	885	920	955	990	1020	1060	1090
10	515	575	625	675	730	775	820	865	905	940	980	1020	1060	1090	1130	1160

SIZE	PR/LI	Tread pattern	Main range of use	Rim size	Permitted rims	OD mm +/-1,5%	SW mm +/-2%	Max. air pressure bar	Max. load kg	Speed (km/h)	RC mm +/-2,5%
<b>23x8.50-12</b>	10	<b>T539 Grey</b>	Scissor lift	7.00		580	220	4,0	900	30	1758

#### PRESSURE

psi	<b>14 17 20 23 26 29 32 35 38 41 43 46 49 52 55 58</b>
bar	<b>1,0 1,2 1,4 1,6 1,8 2,0 2,2 2,4 2,6 2,8 3,0 3,2 3,4 3,6 3,8 4,0</b>

#### MAX. LOAD kg

40	360 400 435 475 510 540 570 605 630 655 685 710 740 760 790 810
<b>30</b>	400 445 485 525 565 600 635 670 700 730 760 790 820 845 875 <b>900</b>
20	455 505 555 600 645 685 725 765 800 830 865 900 935 965 1000 1025
15	485 540 585 635 685 725 770 810 845 885 920 955 990 1020 1060 1090
10	515 575 625 675 730 775 820 865 905 940 980 1020 1060 1090 1130 1160

SIZE	PR/LI	Tread pattern	Main range of use	Rim size	Permitted rims	OD mm +/-1,5%	SW mm +/-2%	Max. air pressure bar	Max. load kg	Speed (km/h)	RC mm +/-2,5%
<b>23x10.50-12</b>	4	<b>T463 TL</b>	Farming	8.5	7JA	572	275	1,4	600	30	1705

SIZE	PR/LI	Tread pattern	Main range of use	Rim size	Permitted rims	OD mm +/-1,5%	SW mm +/-2%	Max. air pressure bar	Max. load kg	Speed (km/h)	RC mm +/-2,5%
<b>23x10.50-12</b>	10	<b>T463 TL</b>	Farming	7.00I	8.50I	574	272	3,6	1000	30	1705

#### PRESSURE

psi	<b>14 17 20 23 26 29 32 35 38 41 43 46 49 52 55 58 61 64 68</b>
bar	<b>1,0 1,2 1,4 1,6 1,8 2,0 2,2 2,4 2,6 2,8 3,0 3,2 3,4 3,6 3,8 4,0 4,2 4,4 4,7</b>

#### MAX. LOAD kg

40 FR	430 475 520 560 600 640 675 710 745 780 810 840 870 900
<b>30 FR</b>	475 525 575 620 665 710 750 790 825 865 900 935 965 <b>1000</b>
10 FR	510 675 740 800 860 915 970 1020 1065 1115 1160 1205 1245 1290
40 DrW	295 335 365 390 420 445 475 495 520 545 565 590 610 630
<b>30 DrW</b>	330 370 405 435 465 495 525 550 580 605 630 655 675 <b>700</b>
10 DrW	425 475 520 560 600 640 675 710 750 780 815 845 870 905
10C	520 585 640 685 735 780 830 865 915 955 995 1035 1065 1105 1135 1175 1205 1240 1295

## Light service tires

X-ply tires for crop processing and green area equipment



SIZE	PR/LI	Tread pattern	Main range of use	Rim size	Permitted rims	OD mm +/-1,5%	SW mm +/-2%	Max. air pressure bar	Max. load kg	Speed (km/h)	RC mm +/-2,5%
<b>23x10.50-12</b>	4	<b>T539 TL</b>	Green Area/Farming	7.00I	8.50I	580	269	1,4	550	30	1723

**PRESSURE**

<b>psi</b>	<b>12</b>	<b>14</b>	<b>17</b>	<b>20</b>	<b>23</b>	<b>26</b>
<b>bar</b>	<b>0,8</b>	<b>1,0</b>	<b>1,2</b>	<b>1,4</b>	<b>1,6</b>	<b>1,8</b>

**MAX. LOAD kg**

40 FR	355	405	455	495		
<b>30 FR</b>	395	450	505	<b>550</b>		
10 FR	510	580	650	710		
40 DrW	250	285	315	345		
<b>30 DrW</b>	280	315	350	<b>385</b>		
10 DrW	360	405	450	495		
10C	440	495	550	605	655	700

SIZE	PR/LI	Tread pattern	Main range of use	Rim size	Permitted rims	OD mm +/-1,5%	SW mm +/-2%	Max. air pressure bar	Max. load kg	Speed (km/h)	RC mm +/-2,5%
<b>23x10.50-12</b>	6	<b>T539 TL</b>	Farming	7.00	8.50	571	247	2,2	800	30	1699

**PRESSURE**

<b>psi</b>	<b>7</b>	<b>12</b>	<b>14</b>	<b>17</b>	<b>20</b>	<b>23</b>	<b>26</b>	<b>29</b>	<b>32</b>
<b>bar</b>	<b>0,5</b>	<b>0,8</b>	<b>1,0</b>	<b>1,2</b>	<b>1,4</b>	<b>1,6</b>	<b>1,8</b>	<b>2,0</b>	<b>2,2</b>

**MAX. LOAD kg**

40	300	400	455	505	555	600	640	680	720
<b>30</b>	335	445	505	560	615	665	710	755	<b>800</b>
20	380	505	575	640	700	760	810	860	910
15	405	540	610	680	745	805	860	915	970
10	430	575	650	720	795	860	915	975	1030

SIZE	PR/LI	Tread pattern	Main range of use	Rim size	Permitted rims	OD mm +/-1,5%	SW mm +/-2%	Max. air pressure bar	Max. load kg	Speed (km/h)	RC mm +/-2,5%
<b>23x10.50-12</b>	6	<b>T539 Grey TL</b>	Industrial	7.00	8.50	571	247	2,2	800	30	1699



SIZE	PR/LI	Tread pattern	Main range of use	Rim size	Permitted rims	OD mm +/-1,5%	SW mm +/-2%	Max. air pressure bar	Max. load kg	Speed (km/h)	RC mm +/-2,5%
<b>23x10.50-12</b>	6/100A6	<b>DRIVER TL</b>	Green Area	7.00	8.50	580	238	2,2	800	30	1720
<b>PRESSURE</b>											
<b>psi</b>			<b>7</b>	<b>12</b>	<b>14</b>	<b>17</b>	<b>20</b>	<b>23</b>	<b>26</b>	<b>29</b>	<b>32</b>
<b>bar</b>			<b>0,5</b>	<b>0,8</b>	<b>1,0</b>	<b>1,2</b>	<b>1,4</b>	<b>1,6</b>	<b>1,8</b>	<b>2,0</b>	<b>2,2</b>
<b>MAX. LOAD kg</b>											
40			300	400	455	505	555	600	640	680	720
<b>30</b>			335	445	505	560	615	665	710	755	<b>800</b>
20			380	505	575	640	700	760	810	860	910
15			405	540	610	680	745	805	860	915	970
10			430	575	650	720	795	860	915	975	1030

SIZE	PR/LI	Tread pattern	Main range of use	Rim size	Permitted rims	OD mm +/-1,5%	SW mm +/-2%	Max. air pressure bar	Max. load kg	Speed (km/h)	RC mm +/-2,5%
<b>23x12.50-12</b>	6	<b>T539 TL</b>	Industrial	10	10.50I	584	317	2,1	925	30	1734
<b>PRESSURE</b>											
<b>psi</b>			<b>7</b>	<b>12</b>	<b>14</b>	<b>17</b>	<b>20</b>	<b>23</b>	<b>26</b>	<b>29</b>	<b>30</b>
<b>bar</b>			<b>0,5</b>	<b>0,8</b>	<b>1,0</b>	<b>1,2</b>	<b>1,4</b>	<b>1,6</b>	<b>1,8</b>	<b>2,0</b>	<b>2,1</b>
<b>MAX. LOAD kg</b>											
40			360	475	540	600	655	710	760	810	835
<b>30</b>			400	525	600	665	730	790	845	900	<b>925</b>
20			455	600	685	760	830	900	965	1025	1055
15			485	635	725	805	885	955	1020	1090	1120
10			515	675	775	860	940	1020	1090	1160	1195

## Light service tires

X-ply tires for crop processing and green area equipment



SIZE	PR/LI	Tread pattern	Main range of use	Rim size	Permitted rims	OD mm +/-1,5%	SW mm +/-2%	Max. air pressure bar	Max. load kg	Speed (km/h)	RC mm +/-2,5%						
26x12.00-12	8	T539 TL	Farming	10.50I	9.50JA	652	320	2,7	1150	30	1936						
<b>PRESSURE</b>																	
psi			<b>12</b>	<b>14</b>	<b>17</b>	<b>20</b>	<b>23</b>	<b>26</b>	<b>29</b>	<b>32</b>	<b>35</b>	<b>38</b>	<b>39</b>	<b>42</b>	<b>45</b>	<b>48</b>	<b>51</b>
bar			<b>0,8</b>	<b>1,0</b>	<b>1,2</b>	<b>1,4</b>	<b>1,6</b>	<b>1,8</b>	<b>2,0</b>	<b>2,2</b>	<b>2,4</b>	<b>2,6</b>	<b>2,7</b>	<b>2,9</b>	<b>3,1</b>	<b>3,3</b>	<b>3,5</b>
<b>MAX. LOAD kg</b>																	
40 FR			510	580	645	705	760	815	870	920	970	1015	1035				
<b>30 FR</b>			565	645	715	785	845	905	965	1020	1075	1125	<b>1150</b>				
10 FR			730	830	920	1015	1090	1165	1245	1315	1385	1450	1485				
40 DrW			355	405	450	495	535	570	610	645	675	705	725				
<b>30 DrW</b>			395	450	500	550	595	635	675	715	750	785	<b>805</b>				
10 DrW			510	580	645	710	770	820	870	920	970	1015	1040				
10C			625	710	790	865	940	1000	1065	1130	1185	1240	1270	1325	1380	1425	1475

SIZE	PR/LI	Tread pattern	Main range of use	Rim size	Permitted rims	OD mm +/-1,5%	SW mm +/-2%	Max. air pressure bar	Max. load kg	Speed (km/h)	RC mm +/-2,5%						
26x12.00-12	8	T539 TT	Farming	10.50I-12	9.50JA-12	652	320	2,7	1150	30	1936						
<b>PRESSURE</b>																	
psi			<b>12</b>	<b>14</b>	<b>17</b>	<b>20</b>	<b>23</b>	<b>26</b>	<b>29</b>	<b>32</b>	<b>35</b>	<b>38</b>	<b>39</b>	<b>42</b>	<b>45</b>	<b>48</b>	<b>51</b>
bar			<b>0,8</b>	<b>1,0</b>	<b>1,2</b>	<b>1,4</b>	<b>1,6</b>	<b>1,8</b>	<b>2,0</b>	<b>2,2</b>	<b>2,4</b>	<b>2,6</b>	<b>2,7</b>	<b>2,9</b>	<b>3,1</b>	<b>3,3</b>	<b>3,5</b>
<b>MAX. LOAD kg</b>																	
40 FR			510	580	645	705	760	815	870	920	970	1015	1035				
<b>30 FR</b>			565	645	715	785	845	905	965	1020	1075	1125	<b>1150</b>				
10 FR			730	830	920	1015	1090	1165	1245	1315	1385	1450	1485				
40 DrW			355	405	450	495	535	570	610	645	675	705	725				
<b>30 DrW</b>			395	450	500	550	595	635	675	715	750	785	<b>805</b>				
10 DrW			510	580	645	710	770	820	870	920	970	1015	1040				
10C			625	710	790	865	940	1000	1065	1130	1185	1240	1270	1325	1380	1425	1475

SIZE	PR/LI	Tread pattern	Main range of use	Rim size	Permitted rims	OD mm +/-1,5%	SW mm +/-2%	Max. air pressure bar	Max. load kg	Speed (km/h)	RC mm +/-2,5%
26x12.00-12	4	T411 TL	Green Area/Farming	10.50I-12	9.50JA-12	646	318	1,4	800	30	1919
<b>PRESSURE</b>											
psi			<b>7</b>	<b>12</b>	<b>14</b>	<b>17</b>	<b>20</b>	<b>23</b>	<b>26</b>		
bar			<b>0,5</b>	<b>0,8</b>	<b>1,0</b>	<b>1,2</b>	<b>1,4</b>	<b>1,6</b>	<b>1,8</b>		
<b>MAX. LOAD kg</b>											
40 FR			395	520	590	655	720				
<b>30 FR</b>			440	575	655	730	<b>800</b>				
10 FR			570	740	845	940	1030				
40 DrW			275	365	415	460	505				
<b>30 DrW</b>			305	405	460	510	<b>560</b>				
10 DrW			395	520	595	660	720				
10C			489	640	725	805	885	955	1025		

SIZE	PR/LI	Tread pattern	Main range of use	Rim size	Permitted rims	OD mm +/-1,5%	SW mm +/-2%	Max. air pressure bar	Max. load kg	Speed (km/h)	RC mm +/-2,5%
26x12.00-12	8	T463 TL	Farming	10.50I	9.50JA	654	318	2,7	1150	30	1942

**PRESSURE**

psi	<b>12</b>	<b>14</b>	<b>17</b>	<b>20</b>	<b>23</b>	<b>26</b>	<b>29</b>	<b>32</b>	<b>35</b>	<b>38</b>	<b>39</b>	<b>42</b>	<b>45</b>	<b>48</b>	<b>51</b>
bar	<b>0,8</b>	<b>1,0</b>	<b>1,2</b>	<b>1,4</b>	<b>1,6</b>	<b>1,8</b>	<b>2,0</b>	<b>2,2</b>	<b>2,4</b>	<b>2,6</b>	<b>2,7</b>	<b>2,9</b>	<b>3,1</b>	<b>3,3</b>	<b>3,5</b>

**MAX. LOAD kg**

40 FR	510	580	645	705	760	815	870	920	970	1015	1035				
<b>30 FR</b>	565	645	715	785	845	905	965	1020	1075	1125	<b>1150</b>				
10 FR	730	830	920	1015	1090	1165	1245	1315	1385	1450	1485				
40 DrW	355	405	450	495	535	570	610	645	675	705	725				
<b>30 DrW</b>	395	450	500	550	595	635	675	715	750	785	<b>805</b>				
10 DrW	510	580	645	710	770	820	870	920	970	1015	1040				
10C	625	710	790	865	940	1000	1065	1130	1185	1240	1270	1325	1380	1425	1475

SIZE	PR/LI	Tread pattern	Main range of use	Rim size	Permitted rims	OD mm +/-1,5%	SW mm +/-2%	Max. air pressure bar	Max. load kg	Speed (km/h)	RC mm +/-2,5%
220/60-12 (23x8.50-12)	88A8/76A8	T539 Soft Grip TL	Green Area	7.00I	7JA	578	224	2,0	560	40	1736

**PRESSURE**

psi	<b>12</b>	<b>14</b>	<b>17</b>	<b>20</b>	<b>23</b>	<b>26</b>	<b>29</b>	<b>32</b>	<b>33</b>	<b>38</b>	<b>41</b>	<b>42</b>
bar	<b>0,8</b>	<b>1,0</b>	<b>1,2</b>	<b>1,4</b>	<b>1,6</b>	<b>1,8</b>	<b>2,0</b>	<b>2,2</b>	<b>2,3</b>	<b>2,6</b>	<b>2,8</b>	<b>2,9</b>

**MAX. LOAD kg**

50 FR	275	320	360	400	440	470	505								
<b>40 FR</b>	305	355	400	445	485	525	<b>560</b>								
10 FR	400	455	510	565	620	670	720	765	785						
50 DrW	195	225	250	280	310	335	360								
<b>40 DrW</b>	220	250	280	310	345	375	<b>400</b>								
10 DrW	285	320	360	395	435	475	510	545	560						
10C	360	400	445	485	530	575	620	665	685	745	785	800			

SIZE	PR/LI	Tread pattern	Main range of use	Rim size	Permitted rims	OD mm +/-1,5%	SW mm +/-2%	Max. air pressure bar	Max. load kg	Speed (km/h)	RC mm +/-2,5%
300/65-12	118A8	T446 TL	Farming	9.00		687	303	2,6	1250	30	2040

SIZE	PR/LI	Tread pattern	Main range of use	Rim size	Permitted rims	OD mm +/-1,5%	SW mm +/-2%	Max. air pressure bar	Max. load kg	Speed (km/h)	RC mm +/-2,5%
320/60-12	132A8	T421 TL/TT	Farming	10.50I		689	320	4,0	2000	40	2049

**PRESSURE**

psi	<b>14</b>	<b>22</b>	<b>29</b>	<b>36</b>	<b>43</b>	<b>46</b>	<b>49</b>	<b>52</b>	<b>55</b>	<b>58</b>	<b>61</b>	<b>64</b>	<b>67</b>	<b>70</b>	<b>72</b>	<b>77</b>	<b>81</b>	<b>84</b>
bar	<b>1,0</b>	<b>1,5</b>	<b>2,0</b>	<b>2,5</b>	<b>3,0</b>	<b>3,2</b>	<b>3,4</b>	<b>3,6</b>	<b>3,8</b>	<b>4,0</b>	<b>4,2</b>	<b>4,4</b>	<b>4,6</b>	<b>4,8</b>	<b>5,0</b>	<b>5,3</b>	<b>5,6</b>	<b>5,8</b>

**MAX. LOAD kg**

50 FR	665	860	1060	1265	1440	1485	1555	1620	1710	1800								
<b>40 FR</b>	740	955	1180	1405	1600	1650	1725	1800	1900	<b>2000</b>								
10 FR	950	1220	1490	1760	2040	2160	2215	2295	2365	2455	2560	2675	2800					
50 DrW	470	610	765	905	1010	1035	1080	1125	1190	1260								
<b>40 DrW</b>	520	675	850	1005	1120	1150	1200	1250	1325	<b>1400</b>								
10 DrW	675	860	1060	1265	1450	1520	1550	1605	1650	1705	1780	1865	1960					
10C	850	1065	1275	1505	1745	1830	1915	1995	2080	2155	2240	2265	2285	2355	2420	2545	2700	2800

**Light service tires**

X-ply tires for crop processing and green area equipment



SIZE	PR/LI	Tread pattern	Main range of use	Rim size	Permitted rims	OD mm +/-1,5%	SW mm +/-2%	Max. air pressure bar	Max. load kg	Speed (km/h)	RC mm +/-2,5%
320/60-12	132A8	T421 Grey TL	Industrial	10.50I		689	320	4,0	2000	40	2049

#### PRESSURE

psi	<b>14</b>	<b>22</b>	<b>29</b>	<b>36</b>	<b>44</b>	<b>46</b>	<b>49</b>	<b>52</b>	<b>55</b>	<b>58</b>	<b>61</b>	<b>64</b>	<b>67</b>	<b>70</b>	<b>73</b>	<b>77</b>
bar	<b>1,0</b>	<b>1,5</b>	<b>2,0</b>	<b>2,5</b>	<b>3,0</b>	<b>3,2</b>	<b>3,4</b>	<b>3,6</b>	<b>3,8</b>	<b>4,0</b>	<b>4,2</b>	<b>4,4</b>	<b>4,6</b>	<b>4,8</b>	<b>5,0</b>	<b>5,3</b>

#### MAX. LOAD kg

50 FR	665	860	1060	1265	1440	1485	1555	1620	1710	1800						
<b>40 FR</b>	740	955	1180	1405	1600	1650	1725	1800	1900	<b>2000</b>						
10 FR	950	1220	1490	1760	2040	2160	2215	2295	2365	2455	2560	2675	2800			
50 DrW	470	610	765	905	1010	1035	1080	1125	1190	1260						
<b>40 DrW</b>	520	675	850	1005	1120	1150	1200	1250	1325	<b>1400</b>						
10 DrW	675	860	1060	1265	1450	1520	1550	1605	1650	1705	1780	1865	1960			
10C	850	1065	1275	1505	1745	1830	1915	1995	2080	2155	2240	2265	2285	2355	2420	2545

SIZE	PR/LI	Tread pattern	Main range of use	Rim size	Permitted rims	OD mm +/-1,5%	SW mm +/-2%	Max. air pressure bar	Max. load kg	Speed (km/h)	RC mm +/-2,5%
560x140-12	100	T528	Snow Groomer	3.00B-12		556	143	8,0	800	20	1705

### TIRES 13"

SIZE	PR/LI	Tread pattern	Main range of use	Rim size	Permitted rims	OD mm +/-1,5%	SW mm +/-2%	Max. air pressure bar	Max. load kg	Speed (km/h)	RC mm +/-2,5%
23x5(5.00-13)	10	T94 TL	Industrial	4.50	3.75	635	155	8,5	1500	25	1913
610x145-13	112	T528	Snow Groomer	4.00		609	150	7,5	1120	20	1856

### TIRES 14"

SIZE	PR/LI	Tread pattern	Main range of use	Rim size	Permitted rims	OD mm +/-1,5%	SW mm +/-2%	Max. air pressure bar	Max. load kg	Speed (km/h)	RC mm +/-2,5%
645x160-14	120	T528	Snow Groomer	4JA-14		645	160	7,0	1400	20	1953

### TIRES 14.5"

SIZE	PR/LI	Tread pattern	Main range of use	Rim size	Permitted rims	OD mm +/-1,5%	SW mm +/-2%	Max. air pressure bar	Max. load kg	Speed (km/h)	RC mm +/-2,5%
200/60-14.5	10	T448 Extra TT/TL	Farming	6.75	8.00	620	206	5,0	950	30	1841
	10	T536	Farming	6.75	8.00	628	204	5,0	950	30	1865

## TIRES 15"

SIZE	PR/LI	Tread pattern	Main range of use	Rim size	Permitted rims	OD mm +/-1,5%	SW mm +/-2%	Max. air pressure bar	Max. load kg	Speed (km/h)	RC mm +/-2,5%
7.00-15	6	<b>TRACTION</b>	Farming	4.50		730	175	2,5	1150	30	2140

### PRESSURE

<b>psi</b>	<b>12</b>	<b>14</b>	<b>17</b>	<b>20</b>	<b>23</b>	<b>26</b>	<b>29</b>	<b>32</b>	<b>36</b>
<b>bar</b>	<b>0,8</b>	<b>1,0</b>	<b>1,2</b>	<b>1,4</b>	<b>1,6</b>	<b>1,8</b>	<b>2,0</b>	<b>2,2</b>	<b>2,5</b>

### MAX. LOAD kg

40 FR	530	610	675	740	795	855	910	960	1035
<b>30 FR</b>	590	675	750	820	885	950	1010	1065	<b>1150</b>
20 FR	675	770	855	930	1010	1085	1150	1215	1310
10 FR	760	870	970	1060	1140	1225	1305	1375	1485
40 DrW	385	430	480	525	570	610	650	690	745
<b>30 DrW</b>	425	480	535	585	635	680	720	765	<b>825</b>
20 DrW	485	545	610	665	725	775	820	870	940
10 DrW	550	620	690	755	820	875	930	985	1065

SIZE	PR/LI	Tread pattern	Main range of use	Rim size	Permitted rims	OD mm +/-1,5%	SW mm +/-2%	Max. air pressure bar	Max. load kg	Speed (km/h)	RC mm +/-2,5%
11L-15	12/121A8	<b>T510 TL</b>	Farming	W8		777	285	3,6	1450	40	

### PRESSURE

<b>psi</b>	<b>12</b>	<b>14</b>	<b>17</b>	<b>20</b>	<b>23</b>	<b>26</b>	<b>29</b>	<b>32</b>	<b>35</b>	<b>37</b>	<b>40</b>	<b>43</b>	<b>46</b>	<b>49</b>	<b>52</b>
<b>bar</b>	<b>0,8</b>	<b>1,0</b>	<b>1,2</b>	<b>1,4</b>	<b>1,6</b>	<b>1,8</b>	<b>2,0</b>	<b>2,2</b>	<b>2,4</b>	<b>2,6</b>	<b>2,8</b>	<b>3,0</b>	<b>3,2</b>	<b>3,4</b>	<b>3,6</b>

### MAX. LOAD kg

50 FR	445	535	620	695	765	830	890	950	1005	1060	1110	1160	1210	1260	1305
<b>40 FR</b>	495	595	690	770	850	920	990	1055	1115	1175	1235	1290	1345	1400	<b>1450</b>
25 FR	590	710	820	915	1010	1095	1175	1255	1330	1400	1470	1535	1600	1665	1725
10 FR	695	835	965	1080	1185	1290	1385	1475	1565	1645	1730	1805	1885	1960	2030
50 DrW	315	380	440	495	540	590	630	675	715	750	790	825	860	895	925
<b>40 DrW</b>	350	425	490	545	600	655	700	750	795	835	875	915	955	995	<b>1030</b>
25 DrW	420	505	580	650	715	780	835	890	945	995	1045	1090	1135	1180	1225
10 DrW	490	595	685	765	845	915	985	1050	1110	1170	1230	1285	1340	1390	1440

SIZE	PR/LI	Tread pattern	Main range of use	Rim size	Permitted rims	OD mm +/-1,5%	SW mm +/-2%	Max. air pressure bar	Max. load kg	Speed (km/h)	RC mm +/-2,5%
<b>29x12.50-15</b>	4	<b>T411</b>	Green Area/Farming	10		743	308	1,3	600	50	2207
	90	<b>T463</b>	Green Area/Farming	10	10LB - 9.00	735	315	1,4	600	50	2200
<b>29x13.50-15</b>	4	<b>T411</b>	Green Area/Farming	10		731	334	1,4	600	50	2171
<b>31x15.50-15</b>	8	<b>T412 TL</b>	Farming	13		818	402	3,1	1250	50	2429
<b>33x12.50-15</b>	6	<b>T413 TL</b>	Green Area/Farming	10		846	320	1,9	1215	50	2513
<b>33x15.50-15</b>	6	<b>T412 TL</b>	Green Area/Farming	13		842	395	1,5	1250	50	2501
	8	<b>T412 TL</b>	Farming	13		842	395	2,0	1600	50	2501

## Light service tires

X-ply tires for crop processing and green area equipment



SIZE	PR/LI	Tread pattern	Main range of use	Rim size	Permitted rims	OD mm +/-1,5%	SW mm +/-2%	Max. air pressure bar	Max. load kg	Speed (km/h)	RC mm +/-2,5%					
<b>320/55-15</b>	123A8	<b>T559 Turf Grip TL</b>	Green Area/Farming	10LB	9.00	730	320	2,8	1550	40	2190					
<b>PRESSURE</b>																
<b>psi</b>			<b>7</b>	<b>12</b>	<b>14</b>	<b>17</b>	<b>20</b>	<b>23</b>	<b>26</b>	<b>29</b>	<b>32</b>	<b>35</b>	<b>38</b>	<b>41</b>	<b>43</b>	<b>46</b>
<b>bar</b>			<b>0,5</b>	<b>0,8</b>	<b>1,0</b>	<b>1,2</b>	<b>1,4</b>	<b>1,6</b>	<b>1,8</b>	<b>2,0</b>	<b>2,2</b>	<b>2,4</b>	<b>2,6</b>	<b>2,8</b>	<b>3,0</b>	<b>3,2</b>
<b>MAX. LOAD kg</b>																
50 FR			460	585	675	765	845	925	995	1060	1160	1260	1330	1395		
<b>40 FR</b>			510	650	750	850	940	1030	1105	1180	1290	1400	1475	<b>1550</b>		
10 FR			675	840	960	1080	1200	1310	1420	1520	1610	1720	1855	1985	2070	2160
50 DrW			325	415	480	540	600	655	710	765	830	900	940	980		
<b>40 DrW</b>			365	460	530	600	665	730	790	850	925	1000	1045	<b>1090</b>		
10 DrW			480	600	680	765	850	925	1005	1080	1155	1235	1330	1415	1470	1520

SIZE	PR/LI	Tread pattern	Main range of use	Rim size	Permitted rims	OD mm +/-1,5%	SW mm +/-2%	Max. air pressure bar	Max. load kg	Speed (km/h)	RC mm +/-2,5%											
<b>320/55-15</b>	133A8/121A8	<b>T421 TL</b>	Industrial	10LB	9.00	735	315	4,0	2060	40	2200											
<b>PRESSURE</b>																						
<b>psi</b>			<b>12</b>	<b>14</b>	<b>17</b>	<b>20</b>	<b>23</b>	<b>26</b>	<b>29</b>	<b>32</b>	<b>35</b>	<b>38</b>	<b>40</b>	<b>43</b>	<b>46</b>	<b>49</b>	<b>52</b>	<b>55</b>	<b>58</b>	<b>61</b>	<b>64</b>	<b>67</b>
<b>bar</b>			<b>0,8</b>	<b>1,0</b>	<b>1,2</b>	<b>1,4</b>	<b>1,6</b>	<b>1,8</b>	<b>2,0</b>	<b>2,2</b>	<b>2,4</b>	<b>2,6</b>	<b>2,8</b>	<b>3,0</b>	<b>3,2</b>	<b>3,4</b>	<b>3,6</b>	<b>3,8</b>	<b>4,0</b>	<b>4,2</b>	<b>4,4</b>	<b>4,6</b>
<b>MAX. LOAD kg</b>																						
50 FR			585	675	765	845	925	995	1060	1160	1260	1330	1395	1465	1530	1600	1665	1760	1855			
<b>40 FR</b>			650	750	850	940	1030	1105	1180	1290	1400	1475	1550	1625	1700	1775	1850	1955	<b>2060</b>			
10 FR			840	960	1080	1200	1310	1420	1520	1610	1720	1855	1985	2070	2160	2250	2345	2435	2525	2635	2750	2885
50 DrW			415	480	540	600	655	710	765	830	900	940	980	1020	1060	1110	1155	1230	1305			
<b>40 DrW</b>			460	530	600	665	730	790	850	925	1000	1045	1090	1135	1180	1235	1285	1365	<b>1450</b>			
10 DrW			600	680	765	850	925	1005	1080	1155	1235	1330	1415	1470	1520	1570	1635	1690	1755	1835	1925	2030

SIZE	PR/LI	Tread pattern	Main range of use	Rim size	Permitted rims	OD mm +/-1,5%	SW mm +/-2%	Max. air pressure bar	Max. load kg	Speed (km/h)	RC mm +/-2,5%	
<b>320/70-15</b>	122	<b>T539 SOFT GRIP</b>	Industrial	10LB		835	340	2,0	1500		2550	
<b>PRESSURE</b>												
<b>psi</b>			<b>7</b>	<b>12</b>	<b>14</b>	<b>17</b>	<b>20</b>	<b>23</b>	<b>26</b>	<b>29</b>	<b>30</b>	<b>33</b>
<b>bar</b>			<b>0,5</b>	<b>0,8</b>	<b>1,0</b>	<b>1,2</b>	<b>1,4</b>	<b>1,6</b>	<b>1,8</b>	<b>2,0</b>	<b>2,1</b>	<b>2,3</b>
<b>MAX. LOAD kg</b>												
50 FR			585	745	850	955	1055	1155	1255	1350		
<b>40 FR</b>			650	825	945	1060	1175	1285	1395	<b>1500</b>		
25 FR			770	980	1120	1260	1395	1530	1660	1785		
10 FR			855	1070	1215	1355	1500	1635	1770	1910	1970	2100
50 Drw			410	520	600	675	755	835	895	955		
<b>40 Drw</b>			455	580	665	750	835	925	995	<b>1060</b>		
25 Drw			545	690	790	895	995	1100	1185	1260		
10 Drw			600	750	855	955	1060	1165	1275	1365	1405	1485

SIZE	PR/LI	Tread pattern	Main range of use	Rim size	Permitted rims	OD mm +/-1,5%	SW mm +/-2%	Max. air pressure bar	Max. load kg	Speed (km/h)	RC mm +/-2,5%
<b>380/60-15</b>	114A8	<b>T539 Soft Grip TL</b>	Green Area	10.00	12.00	829	375	1,2	1180	40	2440
<b>PRESSURE</b>											
<b>psi</b>			<b>7</b>	<b>11</b>	<b>14</b>	<b>17</b>	<b>20</b>	<b>23</b>	<b>24</b>		
<b>bar</b>			<b>0,5</b>	<b>0,8</b>	<b>1,0</b>	<b>1,2</b>	<b>1,4</b>	<b>1,6</b>	<b>1,7</b>		
<b>MAX. LOAD kg</b>											
50 FR			655	835	950	1060					
<b>40 FR</b>			725	925	1055	<b>1180</b>					
10 FR			960	1200	1355	1510	1670				
50 Drw			460	585	675	765					
<b>40 DrW</b>			510	650	750	<b>850</b>					
10 DrW			675	845	960	1080	1200				
10C			880	1070	1200	1325	1465	1600	1675		

SIZE	PR/LI	Tread pattern	Main range of use	Rim size	Permitted rims	OD mm +/-1,5%	SW mm +/-2%	Max. air pressure bar	Max. load kg	Speed (km/h)	RC mm +/-2,5%										
<b>400/50-15</b>	135A8	<b>T463 TL</b>	Farming	13LB		795	400	3,2	2180	40	2351										
<b>PRESSURE</b>																					
<b>psi</b>			<b>7</b>	<b>11</b>	<b>17</b>	<b>23</b>	<b>26</b>	<b>28</b>	<b>31</b>	<b>34</b>	<b>37</b>	<b>40</b>	<b>43</b>	<b>46</b>	<b>48</b>	<b>51</b>	<b>54</b>	<b>57</b>	<b>60</b>	<b>63</b>	<b>67</b>
<b>bar</b>			<b>0,5</b>	<b>0,8</b>	<b>1,2</b>	<b>1,6</b>	<b>1,8</b>	<b>2,0</b>	<b>2,2</b>	<b>2,4</b>	<b>2,6</b>	<b>2,8</b>	<b>3,0</b>	<b>3,2</b>	<b>3,4</b>	<b>3,6</b>	<b>3,8</b>	<b>4,0</b>	<b>4,2</b>	<b>4,4</b>	<b>4,6</b>
<b>MAX. LOAD kg</b>																					
50 FR			600	765	980	1225	1310	1395	1510	1620	1735	1855	1910	1960							
<b>40 FR</b>			670	850	1090	1360	1455	1550	1675	1800	1930	2060	2125	<b>2180</b>							
10 FR			880	1100	1395	1705	1875	2005	2115	2245	2400	2550	2710	2870	2935	3040					
50 DrW			425	540	700	880	930	980	1055	1125	1215	1305	1350	1395							
<b>40 DrW</b>			470	600	775	975	1035	1090	1170	1250	1350	1450	1500	<b>1550</b>							
25 DrW			560	715	920	1160	1230	1295	1395	1485	1605	1725	1785	1845							
10 DrW			620	775	990	1220	1345	1430	1495	1575	1670	1770	1895	2020	2075	2155					
10 C			810	985	1225	1465	1585	1730	1865	1970	2065	2155	2235	2345	2460	2585	2715	2865	2980	3030	3080

SIZE	PR/LI	Tread pattern	Main range of use	Rim size	Permitted rims	OD mm +/-1,5%	SW mm +/-2%	Max. air pressure bar	Max. load kg	Speed (km/h)	RC mm +/-2,5%
<b>690x180-15</b>	100A8	<b>TRACTION</b>	Farming	4.50E		685	179	3,3	800	40	2034

For technical notes about pressure tables please refer to page 260.

### Light service tires

X-ply tires for crop processing and green area equipment



# TH400

Radial line designed for telescopic handlers, backhoes and compact loaders.

The TH400 represents the perfect solution both for farming and for light industrial applications.

Product plus:

- great stability
- maximum resistance to stress and laceration
- superior traction
- outstanding self-cleaning



# TH500

The TH500 tire perfectly matches the requirements of telehandlers and backhoes operating on hard surfaces. Both on the road and in the yard, it provides exactly the performance and reliability you need from a tire.

The TH500 tread design is closed in the center to deliver long tire life and on road performance whilst its open shoulder construction ensures excellent self-cleaning capabilities.



SIZE	SW mm	OD mm	SLR mm	RC mm	SRI	Rim	Permitted rims	Type	Speed Km/h	PRESSURE	
										psi	bar
<b>11LR16 IND</b>									<b>40 S</b>	<b>MAX. LOAD kg</b>	
130A8	280	845	370	2510	400	W8	W10L	TL	30 S		
<b>TH400</b>									25 S		
									10 Cyc S		
									Stat S		

SIZE	SW mm	OD mm	SLR mm	RC mm	SRI	Rim	Permitted rims	Type	Speed Km/h	PRESSURE	
										psi	bar
<b>340/80R18 IND (12.5-18)</b>									<b>50 S</b>	<b>MAX. LOAD kg</b>	
143A8 (143B)	351	994	440	3020	475	11	W10-11SDC W11-12-12SDC	TL	40 S		
<b>TH400</b>									35 S		
									30 S		
									25 S		
									10 Cyc S		
									Stat S		



## SIZE

### TH400

<b>11LR16</b>	<b>IND</b>	<b>130A8</b>	
<b>340/80R18</b>	<b>IND</b>	<b>143A8 (143B)</b>	<b>(12.5-18)</b>
<b>400/70R18</b>	<b>IND</b>	<b>147A8 (147B)</b>	<b>(15.5/70-18)</b>
<b>400/70R20</b>	<b>IND</b>	<b>149A8 (149B)</b>	<b>(16.0/70-20)</b>
<b>400/70R24</b>	<b>IND</b>	<b>152A8 (152B)</b>	<b>(16.0/70-24)</b>
<b>440/80R24</b>	<b>IND</b>	<b>161A8 (161B)</b>	<b>(16.9-24)</b>
<b>460/70R24</b>	<b>IND</b>	<b>159A8 (159B)</b>	<b>(17.5L-24)</b>
<b>500/70R24</b>	<b>IND</b>	<b>164A8 (164B)</b>	<b>(19.5L-24)</b>
<b>480/80R26</b>	<b>IND</b>	<b>160A8 (160B)</b>	<b>(18.4-26)</b>
<b>440/80R28</b>	<b>IND</b>	<b>156A8 (156B)</b>	<b>(16.9-28)</b>

### TH500

<b>340/80R18</b>	<b>IND</b>	<b>143A8 (143B)</b>	<b>(12.5-18)</b>
<b>400/70R20</b>	<b>IND</b>	<b>149A8 (149B)</b>	<b>(16.0/70-20)</b>
<b>460/70R24</b>	<b>IND</b>	<b>159A8 (159B)</b>	<b>(17.5L-24)</b>
<b>500/70R24</b>	<b>IND</b>	<b>164A8 (164B)</b>	<b>(19.5L-24)</b>

17	20	23	26	29	31	35	38	41	43	46	49	52
1,2	1,4	1,6	1,8	2,0	2,2	2,4	2,6	2,8	3,0	3,2	3,4	3,6
900	1005	1095	1200	1305	1395	1500	1595	1690	1805	<b>1900</b>		
925	1035	1130	1235	1345	1435	1545	1645	1740	1860	1955		
965	1075	1170	1285	1395	1495	1605	1710	1810	1930	2035		
1000	1115	1215	1330	1450	1550	1665	1770	1875	2005	2110		
1240	1385	1505	1650	1795	1920	2065	2195	2325	2485	2615	2730	2850
1900	2120	2310	2530	2755	2945	3165	3370	3570	3810	4010	4190	4370

23	29	35	38	41	43	46	49	52	55	58	61	64
1,6	2,0	2,4	2,6	2,8	3,0	3,2	3,4	3,6	3,8	4,0	4,2	4,4
1310	1555	1775	1895	2020	2140	2265	2400	2490	2620	<b>2725</b>		
1310	1555	1775	1895	2020	2140	2265	2400	2490	2620	<b>2725</b>		
1335	1585	1810	1935	2060	2185	2310	2450	2535	2670	2780		
1365	1620	1845	1970	2100	2225	2355	2495	2585	2725	2835		
1390	1650	1880	2010	2140	2270	2400	2545	2635	2775	2890		
1590	1980	2315	2505	2670	2820	2990	3215	3380	3550	3735	3900	4090
2435	3035	3550	3835	4095	4325	4580	4925	5180	5440	5725	5995	6270

### TH400 - TH500

Radial tires for agro industrial equipment



SIZE	SW mm	OD mm	SLR mm	RC mm	SRI	Rim	Permitted rims	Type	Speed Km/h	PRESSURE	
										psi	bar
										MAX. LOAD kg	
<b>400/70R18 IND (15.5/70-18)</b>	403	1010	450	3040	475	13	12 - 12SDC	TL	<b>50 S</b>		
									<b>40 S</b>		
147A8 (147B)									35 S		
									30 S		
<b>TH400</b>									25 S		
	10 Cyc S										
									Stat S		

SIZE	SW mm	OD mm	SLR mm	RC mm	SRI	Rim	Permitted rims	Type	Speed Km/h	PRESSURE	
										psi	bar
										MAX. LOAD kg	
<b>400/70R20 IND (16.0/70-20)</b>	395	1065	475	3200	525	13	12 - 12SDC 13SDC - 14	TL	<b>50 S</b>		
									<b>40 S</b>		
149A8 (149B)									35 S		
									30 S		
<b>TH400</b>									25 S		
	10 Cyc S										
									Stat S		

SIZE	SW mm	OD mm	SLR mm	RC mm	SRI	Rim	Permitted rims	Type	Speed Km/h	PRESSURE	
										psi	bar
										MAX. LOAD kg	
<b>400/70R24 IND (16.0/70-24)</b>	400	1165	520	3520	575	DW13	DW14L - W14L	TL	<b>50 S</b>		
									<b>40 S</b>		
152A8 (152B)									35 S		
									30 S		
<b>TH400</b>									25 S		
	10 Cyc S										
									Stat S		

SIZE	SW mm	OD mm	SLR mm	RC mm	SRI	Rim	Permitted rims	Type	Speed Km/h	PRESSURE	
										psi	bar
										MAX. LOAD kg	
<b>440/80R24 IND (16.9-24)</b>	457	1312	585	3975	625	DW14L	DW15L - 14 TW14L	TL	<b>50 S</b>		
									<b>40 S</b>		
161A8 (161B)									35 S		
									30 S		
<b>TH400</b>									25 S		
	10 Cyc S										
									Stat S		

SIZE	SW mm	OD mm	SLR mm	RC mm	SRI	Rim	Permitted rims	Type	Speed Km/h	PRESSURE	
										psi	bar
										MAX. LOAD kg	
<b>460/70R24 IND (17.5L-24)</b>	465	1250	555	3790	600	DW15L	DW14L-DW16L 14-TW14L	TL	<b>50 S</b>		
									<b>40 S</b>		
159A8 (159B)									35 S		
									30 S		
<b>TH400</b>									25 S		
	10 Cyc S										
									Stat S		

<b>23</b>	<b>29</b>	<b>35</b>	<b>38</b>	<b>41</b>	<b>43</b>	<b>46</b>	<b>49</b>	<b>52</b>	<b>55</b>	<b>58</b>	<b>61</b>	<b>64</b>
<b>1,6</b>	<b>2,0</b>	<b>2,4</b>	<b>2,6</b>	<b>2,8</b>	<b>3,0</b>	<b>3,2</b>	<b>3,4</b>	<b>3,6</b>	<b>3,8</b>	<b>4,0</b>	<b>4,2</b>	<b>4,4</b>
1480	1755	2000	2140	2280	2415	2555	2710	2805	2955	<b>3075</b>		
1480	1755	2000	2140	2280	2415	2555	2710	2805	2955	<b>3075</b>		
1510	1790	2040	2180	2325	2465	2605	2765	2865	3015	3140		
1540	1825	2080	2225	2370	2515	2655	2815	2920	3075	3200		
1565	1860	2120	2270	2415	2560	2710	2870	2975	3130	3260		
1795	2235	2615	2825	3015	3185	3375	3625	3815	4005	4215	4400	4615
2745	3425	4005	4330	4620	4880	5170	5555	5845	6135	6460	6765	7075

<b>23</b>	<b>29</b>	<b>35</b>	<b>38</b>	<b>41</b>	<b>43</b>	<b>46</b>	<b>49</b>	<b>52</b>	<b>55</b>	<b>58</b>	<b>61</b>	<b>64</b>
<b>1,6</b>	<b>2,0</b>	<b>2,4</b>	<b>2,6</b>	<b>2,8</b>	<b>3,0</b>	<b>3,2</b>	<b>3,4</b>	<b>3,6</b>	<b>3,8</b>	<b>4,0</b>	<b>4,2</b>	<b>4,4</b>
1560	1855	2115	2260	2405	2555	2700	2860	2965	3120	<b>3250</b>		
1560	1855	2115	2260	2405	2555	2700	2860	2965	3120	<b>3250</b>		
1595	1890	2155	2305	2455	2605	2755	2920	3025	3185	3315		
1625	1930	2200	2350	2505	2655	2810	2975	3085	3245	3380		
1655	1965	2240	2395	2550	2705	2860	3035	3145	3310	3445		
1895	2360	2765	2985	3185	3365	3565	3830	4030	4230	4455	4650	4875
2905	3620	4235	4575	4880	5155	5460	5870	6180	6485	6825	7150	7475

<b>23</b>	<b>29</b>	<b>35</b>	<b>38</b>	<b>41</b>	<b>43</b>	<b>46</b>	<b>49</b>	<b>52</b>	<b>55</b>	<b>58</b>	<b>61</b>	<b>64</b>
<b>1,6</b>	<b>2,0</b>	<b>2,4</b>	<b>2,6</b>	<b>2,8</b>	<b>3,0</b>	<b>3,2</b>	<b>3,4</b>	<b>3,6</b>	<b>3,8</b>	<b>4,0</b>	<b>4,2</b>	<b>4,4</b>
1705	2025	2310	2470	2630	2790	2950	3125	3240	3410	<b>3550</b>		
1705	2025	2310	2470	2630	2790	2950	3125	3240	3410	<b>3550</b>		
1740	2065	2355	2520	2680	2845	3010	3190	3305	3480	3625		
1775	2105	2400	2570	2735	2900	3065	3250	3370	3545	3695		
1810	2145	2450	2620	2785	2955	3125	3315	3435	3615	3765		
2070	2580	3020	3260	3480	3675	3895	4185	4405	4625	4865	5080	5325
3170	3955	4625	4995	5335	5630	5965	6415	6750	7085	7455	7810	8165

<b>23</b>	<b>29</b>	<b>35</b>	<b>38</b>	<b>41</b>	<b>43</b>	<b>46</b>	<b>49</b>	<b>52</b>	<b>55</b>	<b>58</b>	<b>61</b>	<b>64</b>
<b>1,6</b>	<b>2,0</b>	<b>2,4</b>	<b>2,6</b>	<b>2,8</b>	<b>3,0</b>	<b>3,2</b>	<b>3,4</b>	<b>3,6</b>	<b>3,8</b>	<b>4,0</b>	<b>4,2</b>	<b>4,4</b>
2220	2640	3010	3215	3425	3635	3840	4070	4220	4440	<b>4625</b>		
2220	2640	3010	3215	3425	3635	3840	4070	4220	4440	<b>4625</b>		
2265	2690	3070	3280	3495	3705	3920	4155	4305	4530	4720		
2310	2745	3130	3345	3560	3780	3995	4235	4390	4620	4810		
2355	2795	3190	3410	3630	3850	4070	4315	4475	4710	4905		
2695	3360	3930	4250	4535	4785	5070	5450	5735	6020	6340	6615	6940
4130	5150	6025	6510	6945	7335	7770	8355	8790	9230	9715	10175	10640

<b>23</b>	<b>29</b>	<b>35</b>	<b>38</b>	<b>41</b>	<b>43</b>	<b>46</b>	<b>49</b>	<b>52</b>	<b>55</b>	<b>58</b>	<b>61</b>	<b>64</b>
<b>1,6</b>	<b>2,0</b>	<b>2,4</b>	<b>2,6</b>	<b>2,8</b>	<b>3,0</b>	<b>3,2</b>	<b>3,4</b>	<b>3,6</b>	<b>3,8</b>	<b>4,0</b>	<b>4,2</b>	<b>4,4</b>
2100	2495	2845	3045	3240	3435	3635	3850	3990	4200	<b>4375</b>		
2100	2495	2845	3045	3240	3435	3635	3850	3990	4200	<b>4375</b>		
2145	2545	2905	3105	3305	3505	3705	3930	4070	4285	4465		
2185	2595	2960	3165	3370	3575	3780	4005	4150	4370	4550		
2230	2645	3015	3225	3435	3645	3850	4085	4230	4455	4640		
2550	3180	3720	4020	4290	4530	4795	5155	5425	5695	5995	6260	6565
3905	4870	5700	6160	6570	6940	7350	7905	8315	8730	9190	9625	10065

## TH400 - TH500

Radial tires for agro industrial equipment



SIZE	SW mm	OD mm	SLR mm	RC mm	SRI	Rim	Permitted rims	Type	Speed Km/h	PRESSURE		
										psi	bar	MAX. LOAD kg
<b>500/70R24 IND (19.5L-24)</b>	164A8 (164B)	495	1302	580	3940	625	DW16L	DW15L - 16	TL	50 S		
										40 S		
										35 S		
										30 S		
										25 S		
<b>TH400</b>			10 Cyc S			Stat S						

SIZE	SW mm	OD mm	SLR mm	RC mm	SRI	Rim	Permitted rims	Type	Speed Km/h	PRESSURE		
										psi	bar	MAX. LOAD kg
<b>480/80R26 IND (18.4-26)</b>	160A8 (160B)	495	1425	630	4315	675	DW15L	DW16L	TL	50 S		
										40 S		
										35 S		
										30 S		
										25 S		
<b>TH400</b>			10 Cyc S			Stat S						

SIZE	SW mm	OD mm	SLR mm	RC mm	SRI	Rim	Permitted rims	Type	Speed Km/h	PRESSURE		
										psi	bar	MAX. LOAD kg
<b>440/80R28 IND (16.9-28)</b>	156A8 (156B)	457	1418	633	4295	675	DW14L	DW15L	TL	50 S		
										40 S		
										35 S		
										30 S		
										25 S		
<b>TH400</b>			10 Cyc S			Stat S						

SIZE	SW mm	OD mm	SLR mm	RC mm	SRI	Rim	Permitted rims	Type	Speed Km/h	PRESSURE		
										psi	bar	MAX. LOAD kg
<b>340/80R18 IND</b>	143A8 (143B)	351	990	440	2965	475	11	W10 11SDC W11 12 12SDC	TL	50 S		
										40 S		
										35 S		
										30 S		
										25 S		
<b>TH500</b>			10 Cyc S			Stat S						

SIZE	SW mm	OD mm	SLR mm	RC mm	SRI	Rim	Permitted rims	Type	Speed Km/h	PRESSURE		
										psi	bar	MAX. LOAD kg
<b>400/70R20 IND</b>	149A8 (149B)	405	1070	475	3170	525	13	12 12SDC 13SDC 14	TL	50 S		
										40 S		
										35 S		
										30 S		
										25 S		
<b>TH500</b>			10 Cyc S			Stat S						

<b>23</b>	<b>29</b>	<b>35</b>	<b>38</b>	<b>41</b>	<b>43</b>	<b>46</b>	<b>49</b>	<b>52</b>	<b>55</b>	<b>58</b>	<b>61</b>	<b>64</b>
<b>1,6</b>	<b>2,0</b>	<b>2,4</b>	<b>2,6</b>	<b>2,8</b>	<b>3,0</b>	<b>3,2</b>	<b>3,4</b>	<b>3,6</b>	<b>3,8</b>	<b>4,0</b>	<b>4,2</b>	<b>4,4</b>
2400	2850	3250	3475	3700	3925	4150	4400	4560	4800	<b>5000</b>		
2400	2850	3250	3475	3700	3925	4150	4400	4560	4800	<b>5000</b>		
2450	2910	3315	3545	3775	4005	4235	4490	4655	4900	5100		
2500	2965	3380	3615	3850	4085	4320	4580	4745	4995	5200		
2545	3025	3445	3685	3925	4165	4400	4665	4835	5090	5300		
2915	3635	4250	4590	4900	5175	5480	5895	6200	6510	6850	7150	7500
4465	5565	6510	7035	7510	7930	8400	9030	9505	9975	10500	11000	11500

<b>23</b>	<b>26</b>	<b>29</b>	<b>32</b>	<b>35</b>	<b>38</b>	<b>41</b>	<b>43</b>	<b>46</b>	<b>49</b>	<b>52</b>
<b>1,6</b>	<b>1,8</b>	<b>2,0</b>	<b>2,2</b>	<b>2,4</b>	<b>2,6</b>	<b>2,8</b>	<b>3,0</b>	<b>3,2</b>	<b>3,4</b>	<b>3,6</b>
2610	2835	3060	3310	3555	3780	4005	4255	<b>4500</b>		
2610	2835	3060	3310	3555	3780	4005	4255	<b>4500</b>		
2665	2895	3125	3375	3630	3860	4090	4340	4590		
2715	2950	3185	3440	3700	3935	4170	4425	4680		
2770	3010	3245	3510	3770	4010	4250	4510	4770		
3240	3580	3915	4285	4655	4995	5365	5800	6165	6435	6750
4965	5485	6005	6570	7135	7655	8225	8885	9450	9900	10350

<b>23</b>	<b>26</b>	<b>29</b>	<b>32</b>	<b>35</b>	<b>38</b>	<b>41</b>	<b>43</b>	<b>46</b>	<b>49</b>	<b>52</b>
<b>1,6</b>	<b>1,8</b>	<b>2,0</b>	<b>2,2</b>	<b>2,4</b>	<b>2,6</b>	<b>2,8</b>	<b>3,0</b>	<b>3,2</b>	<b>3,4</b>	<b>3,6</b>
2320	2520	2720	2940	3160	3360	3560	3780	<b>4000</b>		
2320	2520	2720	2940	3160	3360	3560	3780	<b>4000</b>		
2370	2575	2775	3000	3225	3430	3635	3860	4080		
2415	2625	2830	3060	3290	3495	3705	3935	4160		
2460	2675	2885	3120	3350	3565	3775	4010	4240		
2880	3180	3480	3810	4140	4440	4770	5155	5480	5720	6000
4410	4875	5335	5840	6345	6805	7310	7900	8400	8800	9200

<b>23</b>	<b>29</b>	<b>35</b>	<b>38</b>	<b>41</b>	<b>44</b>	<b>46</b>	<b>49</b>	<b>52</b>	<b>55</b>	<b>58</b>	<b>61</b>	<b>64</b>
<b>1,6</b>	<b>2,0</b>	<b>2,4</b>	<b>2,6</b>	<b>2,8</b>	<b>3,0</b>	<b>3,2</b>	<b>3,4</b>	<b>3,6</b>	<b>3,8</b>	<b>4,0</b>	<b>4,2</b>	<b>4,4</b>
1310	1555	1775	1895	2020	2140	2265	2400	2490	2620	<b>2725</b>		
1310	1555	1775	1895	2020	2140	2265	2400	2490	2620	<b>2725</b>		
1335	1585	1810	1935	2060	2185	2310	2450	2535	2670	2780		
1365	1620	1845	1970	2100	2225	2355	2495	2585	2725	2835		
1390	1650	1880	2010	2140	2270	2400	2545	2635	2775	2890		
1590	1980	2315	2505	2670	2820	2990	3215	3380	3550	3735	3900	4090
2435	3035	3550	3835	4095	4325	4580	4925	5180	5440	5725	5995	6270

<b>23</b>	<b>29</b>	<b>35</b>	<b>38</b>	<b>41</b>	<b>44</b>	<b>46</b>	<b>49</b>	<b>52</b>	<b>55</b>	<b>58</b>	<b>61</b>	<b>64</b>
<b>1,6</b>	<b>2,0</b>	<b>2,4</b>	<b>2,6</b>	<b>2,8</b>	<b>3,0</b>	<b>3,2</b>	<b>3,4</b>	<b>3,6</b>	<b>3,8</b>	<b>4,0</b>	<b>4,2</b>	<b>4,4</b>
1560	1855	2115	2260	2405	2555	2700	2860	2965	3120	<b>3250</b>		
1560	1855	2115	2260	2405	2555	2700	2860	2965	3120	<b>3250</b>		
1595	1890	2155	2305	2455	2605	2755	2920	3025	3185	3315		
1625	1930	2200	2350	2505	2655	2810	2975	3085	3245	3380		
1655	1965	2240	2395	2550	2705	2860	3035	3145	3310	3445		
1895	2360	2765	2985	3185	3365	3565	3830	4030	4230	4455	4650	4875
2905	3620	4235	4575	4880	5155	5460	5870	6180	6485	6825	7150	7475

## TH400 - TH500

Radial tires for agro industrial equipment



SIZE	SW mm	OD mm	SLR mm	RC mm	SRI	Rim	Permitted rims	Type	Speed Km/h	PRESSURE	
										psi	bar
<b>460/70R24 IND</b>	470	1250	560	3735	600	DW15L	DW14L DW16L TW14L	TL	<b>50 S</b>		
									<b>40 S</b>		
159A8 (159B)									35 S		
									30 S		
<b>TH500</b>									25 S		
	10 Cyc S										
									Stat S		

SIZE	SW mm	OD mm	SLR mm	RC mm	SRI	Rim	Permitted rims	Type	Speed Km/h	PRESSURE	
										psi	bar
<b>500/70R24 IND</b>	500	1300	575	3885	625	DW16L	DW15L - 16	TL	<b>50 S</b>		
									<b>40 S</b>		
164A8 (164B)									35 S		
									30 S		
<b>TH500</b>									25 S		
	10 Cyc S										
									Stat S		

<b>23</b>	<b>29</b>	<b>35</b>	<b>38</b>	<b>41</b>	<b>44</b>	<b>46</b>	<b>49</b>	<b>52</b>	<b>55</b>	<b>58</b>	<b>61</b>	<b>64</b>
<b>1,6</b>	<b>2,0</b>	<b>2,4</b>	<b>2,6</b>	<b>2,8</b>	<b>3,0</b>	<b>3,2</b>	<b>3,4</b>	<b>3,6</b>	<b>3,8</b>	<b>4,0</b>	<b>4,2</b>	<b>4,4</b>
2100	2495	2845	3045	3240	3435	3635	3850	3990	4200	<b>4375</b>		
2100	2495	2845	3045	3240	3435	3635	3850	3990	4200	<b>4375</b>		
2145	2545	2905	3105	3305	3505	3705	3930	4070	4285	4465		
2185	2595	2960	3165	3370	3575	3780	4005	4150	4370	4550		
2230	2645	3015	3225	3435	3645	3850	4085	4230	4455	4640		
2550	3180	3720	4020	4290	4530	4795	5155	5425	5695	5995	6260	6565
3905	4870	5700	6160	6570	6940	7350	7905	8315	8730	9190	9625	10065

<b>23</b>	<b>29</b>	<b>35</b>	<b>38</b>	<b>41</b>	<b>44</b>	<b>46</b>	<b>49</b>	<b>52</b>	<b>55</b>	<b>58</b>	<b>61</b>	<b>64</b>
<b>1,6</b>	<b>2,0</b>	<b>2,4</b>	<b>2,6</b>	<b>2,8</b>	<b>3,0</b>	<b>3,2</b>	<b>3,4</b>	<b>3,6</b>	<b>3,8</b>	<b>4,0</b>	<b>4,2</b>	<b>4,4</b>
2400	2850	3250	3475	3700	3925	4150	4400	4560	4800	<b>5000</b>		
2400	2850	3250	3475	3700	3925	4150	4400	4560	4800	<b>5000</b>		
2450	2910	3315	3545	3775	4005	4235	4490	4655	4900	5100		
2500	2965	3380	3615	3850	4085	4320	4580	4745	4995	5200		
2545	3025	3445	3685	3925	4165	4400	4665	4835	5090	5300		
2915	3635	4250	4590	4900	5175	5480	5895	6200	6510	6850	7150	7500
4465	5565	6510	7035	7510	7930	8400	9030	9505	9975	10500	11000	11500

For technical notes about pressure tables please refer to page 260.

## TH400 - TH500

Radial tires for agro industrial equipment



# MPT100

Steel belted tire designed for multi-purpose off-road trucks. The MPT100 stands out for its great wear resistance, stability and comfort while running on or off the road. In the field it delivers excellent traction.



SIZE	SW mm	OD mm	SLR mm	RC mm	SRI	Rim	Permitted rims	Type	Speed Km/h	PRESSURE	
										psi	bar
425/75R20 MPT  158G  MPT100	435	1150	515	3460		13	11 - 11SDC - 13SDC	TL		90 S	MAX. LOAD kg
										65 S	
										50 S	
										40 S	
										30 S	
10 S											

SIZE	SW mm	OD mm	SLR mm	RC mm	SRI	Rim	Permitted rims	Type	Speed Km/h	PRESSURE	
										psi	bar
405/70R20 MPT  136G  MPT100	420	1065	485	3215		11	13 - 11SDC	TL		90 S	MAX. LOAD kg
										65 S	
										50 S	
										40 S	
										30 S	
10 S											

SIZE	SW mm	OD mm	SLR mm	RC mm	SRI	Rim	Permitted rims	Type	Speed Km/h	PRESSURE	
										psi	bar
445/65R22.5 MPT  160G  MPT100	460	1175	535	3560		14.00		TL		90 S	MAX. LOAD kg
										65 S	
										50 S	
										40 S	
										30 S	
10 S											

**Design data** = the dimensions of size in design data are calculated dimensions and not measured data on the normal production tire



## SIZE

NEW **425/75R20 MPT 158G**

NEW **405/70R20 MPT 136G**

NEW **445/65R22.5 MPT 160G**

9 0,6	11 0,8	14 1,0	17 1,2	20 1,4	23 1,6	29 2,0	36 2,5	44 3,0	51 3,5	58 4,0	65 4,5	72 5,0
		1120	1260	1400	1540	1810	2150	2490	2820	3150	3650	<b>4250</b>
		1210	1360	1510	1670	1970	2340	2700	3060	3420	3960	4610
		1250	1410	1560	1720	2030	2410	2790	3160	3530	4090	4760
	1120	1280	1440	1610	1770	2090	2480	2860	3240	3620	4200	4890
1050	1220	1400	1570	1740	1920	2270	2690	3110	3530	3940	4560	5310
1510	1760	2010	2260	2510	2760	3270	3880	4480	5080	5670	6570	7650

9 0,6	11 0,8	14 1,0	17 1,2	20 1,4	23 1,6	29 2,0	36 2,5	44 3,0	51 3,5
		970	1090	1210	1340	1580	1820	2040	<b>2240</b>
		1050	1190	1320	1450	1710	1970	2210	2430
		1090	1220	1360	1500	1770	2040	2280	2510
	980	1120	1260	1400	1540	1820	2090	2350	2580
910	1060	1210	1370	1520	1670	1970	2270	2550	2800
1310	1530	1750	1970	2190	2400	2840	3270	3670	4030

9 0,6	11 0,8	14 1,0	17 1,2	20 1,4	23 1,6	29 2,0	36 2,5	44 3,0	51 3,5	58 4,0	65 4,5	87 6,0
		1270	1430	1580	1740	2060	2410	2750	3075	3390	3690	<b>4500</b>
		1370	1550	1720	1890	2235	2615	2985	3340	3675	4000	4885
		1420	1600	1770	1950	2305	2700	3080	3445	3795	4130	5040
	1280	1460	1640	1820	2005	2365	2770	3165	3540	3900	4240	5175
1190	1390	1580	1780	1980	2175	2575	3015	3440	3845	4235	4610	5625
1710	2000	2280	2570	2850	3135	3705	4340	4950	5540	6100	6640	8100

For technical notes about pressure tables please refer to page 260.

### MPT100

Radial tire for agro industrial equipment



# TB40

Trelleborg backhoes range, designed for construction utility and industrial application.

Product plus:

- excellent wear resistance
- sturdy tread pattern
- robust sidewall
- great stability on hard and tough soils



SIZE	New tire		Tire in service				Rim	Type	Speed Km/h	PRESSURE	
	SW mm	OD mm	SW mm	OD mm	SLR mm	RC mm				psi	bar
<b>320/80-18 IND (12.5-18)</b>									50		
									<b>40</b>		
139A8	308	987	334	1005	445	2980	DW9	TL	30		
									20		
									10		
<b>TB40</b>									5		
											<b>MAX. LOAD kg</b>

SIZE	New tire		Tire in service				Rim	Type	Speed Km/h	PRESSURE	
	SW mm	OD mm	SW mm	OD mm	SLR mm	RC mm				psi	bar
<b>340/80-18 IND</b>									50		
									<b>40</b>		
143A8	350	1005	370	1025	450	3055	11	TL	30		
									20		
									10		
<b>TB40</b>									5		
											<b>MAX. LOAD kg</b>

SIZE	New tire		Tire in service				Rim	Type	Speed Km/h	PRESSURE	
	SW mm	OD mm	SW mm	OD mm	SLR mm	RC mm				psi	bar
<b>440/80-28 IND (16.9-28)</b>									50		
									<b>40</b>		
156A8	436	1418	488	1465	637	4312	DW15L	TL	30		
									20		
									10		
<b>TB40</b>									5		
											<b>MAX. LOAD kg</b>

## SIZE

**320/80-18 IND R-4 139A8 (12.5-18)**

**340/80-18 IND R-4 143A8**

**440/80-28 IND R-4 156A8 (16.9-28)**

17	23	29	35	41	46	51	58
1,2	1,6	2,0	2,4	2,8	3,2	3,5	4,0
860	1060	1260	1435	1635	1835	1970	2210
950	1165	1385	1580	1800	2015	2165	<b>2430</b>
985	1215	1440	1645	1870	2100	2250	2525
1035	1270	1510	1720	1960	2200	2355	2650
1185	1460	1730	1975	2250	2520	2705	3040
1375	1690	2010	2290	2605	2925	3135	3525

17	23	29	35	41	46	51	58
1,2	1,6	2,0	2,4	2,8	3,2	3,5	4,0
965	1190	1415	1610	1835	2060	2205	2480
1065	1310	1555	1770	2015	2260	2425	<b>2725</b>
1105	1360	1615	1840	2095	2350	2520	2835
1160	1425	1695	1930	2200	2465	2645	2970
1330	1635	1940	2215	2520	2825	3030	3405
1540	1895	2250	2570	2925	3280	3515	3950

12	14	17	23	29	35	38	41	43	46
0,8	1,0	1,2	1,6	2,0	2,4	2,6	2,8	3,0	3,2
1340	1535	1725	2105	2490	2875	3065	3255	3450	3640
1475	1685	1895	2315	2735	3160	3370	3580	3790	<b>4000</b>
1535	1750	1970	2410	2845	3285	3505	3720	3940	4160
1605	1835	2065	2525	2985	3440	3670	3900	4130	4360
1840	2105	2370	2895	3420	3945	4210	4475	4735	5000
2135	2440	2745	3360	3975	4580	4885	5190	5495	5800

For technical notes about pressure tables please refer to page 260.

## TB40

X-ply tire for agro industrial equipment



# T440 EXC



# T480 EXC



# T459



SIZE	SW mm	OD mm	SLR mm	RC mm	SRI mm	Rim	Permitted rim	Type	Speed Km/h	PRESSURE	
										psi	bar
<b>600/50-22.5</b>	620	1180	540	3570	550	AG20.00		TL	50	MAX. LOAD kg	
173A8									<b>40</b>		
<b>T480 EXC</b>									10		
									0		

SIZE	SW mm	OD mm	SLR mm	RC mm	SRI mm	Rim	Permitted rim	Type	Speed Km/h	PRESSURE	
										psi	bar
<b>650/45-22.5</b>	650	1160	530	3520	550	AG20.00	AG22.00 AG24.00	TL	50	MAX. LOAD kg	
175A8									<b>40</b>		
<b>T440 EXC</b>									10		
									0		

### T440 EXC - T480 EXC - T459

Recommended for excavators, loaders and for machines in urban and industrial operations. Good grip and braking capability on hard surfaces.

SIZE		
<b>600/50-22.5</b>	<b>173A8</b>	<b>T480 EXC</b>
<b>650/45-22.5</b>	<b>175A8</b>	<b>T440 EXC</b>
<b>710/40-22.5</b>	<b>176A8</b>	<b>T480 EXC</b>
<b>620/60B34</b>	<b>175A8</b>	<b>T459 HD</b>
<b>600/65-34</b>	<b>175A8</b>	<b>T440 LD SB</b>

23	29	35	39	43	46	51	55	58	61	65	68	72	75	78	81	84	87
1,6	2,0	2,4	2,7	3,0	3,2	3,5	3,8	4,0	4,2	4,5	4,7	5,0	5,2	5,4	5,6	5,8	6,0
2060	2400	2725	2995	3270	3450	3705	3960	4125	4325	4630	4840	5150	5320	5490	5660	5830	6000
2240	2625	3000	3285	3565	3750	4075	4405	4625	4820	5115	5310	5600	5785	5965	6145	6320	<b>6500</b>
2870	3330	3780	4120	4455	4680	5070	5465	5730	5965	6315	6550	6900	7120	7335	7550	7765	7975
5150	6035	6900	7555	8200	8625	9370	10130	10640	11090	11760	12210	12880	13300	13715	14130	14540	14950

23	29	35	43	51	58	65	72	78	84	87
1,6	2,0	2,4	3,0	3,5	4,0	4,5	5,0	5,4	5,8	6,0
2120	2465	2800	3360	3815	4250	4770	5300	5645	5980	6150
2360	2725	3075	3675	4200	4750	5275	5800	6240	6680	<b>6900</b>
3025	3460	3875	4595	5225	5885	6515	7145	7670	8200	8470
5430	6275	7075	8455	9660	10925	12130	13340	14345	15360	15870

### Industrial Tractors - T440 EXC - T480 EXC - T459

X-ply tires for agro industrial equipment



SIZE	SW mm	OD mm	SLR mm	RC mm	SRI mm	Rim	Permitted rim	Type	Speed Km/h	PRESSURE	
										psi	bar
<b>710/40-22.5</b> 176A8 <b>T480 EXC</b>	710	1170	540	3605	550	AG24.00		TL	50		
									<b>40</b>		
									10		
									0		

SIZE	SW mm	OD mm	SLR mm	RC mm	SRI mm	Rim	Permitted rim	Type	Speed Km/h	PRESSURE	
										psi	bar
<b>620/60B34</b> 175A8 <b>T459</b>	625	1608	750	4860	755	DW20B		TL	50		
									<b>40</b>		
									10		
									0		

SIZE	SW mm	OD mm	SLR mm	RC mm	SRI mm	Rim	Permitted rim	Type	Speed Km/h	PRESSURE	
										psi	bar
<b>600/65-34</b> 175A8 <b>T440 LD SB</b>	600	1650	765	5070	775	DW20A		TL	50 S		
									<b>40 S</b>		
									30 S		
									20 S		
									10 S		
									10 Cyc S		
									Stat S		

<b>23</b>	<b>29</b>	<b>35</b>	<b>39</b>	<b>43</b>	<b>46</b>	<b>51</b>	<b>55</b>	<b>58</b>	<b>61</b>	<b>65</b>	<b>68</b>	<b>72</b>	<b>75</b>	<b>78</b>	<b>81</b>	<b>84</b>	<b>87</b>
<b>1,6</b>	<b>2,0</b>	<b>2,4</b>	<b>2,7</b>	<b>3,0</b>	<b>3,2</b>	<b>3,5</b>	<b>3,8</b>	<b>4,0</b>	<b>4,2</b>	<b>4,5</b>	<b>4,7</b>	<b>5,0</b>	<b>5,2</b>	<b>5,4</b>	<b>5,6</b>	<b>5,8</b>	<b>6,0</b>
2180	2545	2900	3180	3465	3650	3965	4285	4500	4690	4975	5165	5450	5660	5865	6075	6290	6500
2430	2800	3150	3470	3785	4000	4325	4655	4875	5100	5435	5660	6000	6220	6440	6660	6880	<b>7100</b>
3115	3555	3970	4350	4735	4990	5385	5775	6040	6310	6715	6985	7395	7655	7920	8185	8450	8715
5590	6440	7245	7975	8710	9200	9950	10710	11215	11725	12500	13020	13800	14305	14810	15315	15825	16330

<b>12</b>	<b>14</b>	<b>17</b>	<b>20</b>	<b>23</b>	<b>26</b>	<b>29</b>	<b>32</b>	<b>35</b>	<b>38</b>	<b>41</b>	<b>43</b>	<b>46</b>	<b>49</b>	<b>52</b>	<b>55</b>	<b>58</b>
<b>0,8</b>	<b>1,0</b>	<b>1,2</b>	<b>1,4</b>	<b>1,6</b>	<b>1,8</b>	<b>2,0</b>	<b>2,2</b>	<b>2,4</b>	<b>2,6</b>	<b>2,8</b>	<b>3,0</b>	<b>3,2</b>	<b>3,4</b>	<b>3,6</b>	<b>3,8</b>	<b>4,0</b>
1955	2230	2510	2790	3075	3315	3550	3780	4000	4285	4570	4860	5150	5400	5655	5900	6150
2145	2450	2760	3065	3350	3640	3930	4215	4500	4780	5055	5330	5600	5920	6245	6570	<b>6900</b>
2850	3220	3585	3955	4295	4640	4985	5330	5670	6005	6335	6660	6985	7370	7760	8155	8550
4935	5640	6345	7050	7705	8375	9040	9695	10350	10990	11625	12255	12880	13620	14360	15115	15870

<b>12</b>	<b>14</b>	<b>17</b>	<b>20</b>	<b>23</b>	<b>26</b>	<b>29</b>	<b>32</b>	<b>35</b>	<b>38</b>	<b>41</b>	<b>43</b>	<b>46</b>	<b>49</b>	<b>52</b>	<b>55</b>	<b>58</b>
<b>0,8</b>	<b>1,0</b>	<b>1,2</b>	<b>1,4</b>	<b>1,6</b>	<b>1,8</b>	<b>2,0</b>	<b>2,2</b>	<b>2,4</b>	<b>2,6</b>	<b>2,8</b>	<b>3,0</b>	<b>3,2</b>	<b>3,4</b>	<b>3,6</b>	<b>3,8</b>	<b>4,0</b>
1910	2185	2455	2730	3005	3275	3550	3820	4095	4370	4640	4915	5185	5460	5735	6005	6280
2100	2400	2700	3000	3300	3600	3900	4200	4500	4800	5100	5400	5700	6000	6300	6600	<b>6900</b>
2185	2495	2810	3120	3430	3745	4055	4370	4680	4990	5305	5615	5930	6240	6550	6865	7175
2290	2615	2945	3270	3595	3925	4250	4580	4905	5230	5560	5885	6215	6540	6865	7195	7520
2625	3000	3375	3750	4125	4500	4875	5250	5625	6000	6375	6750	7125	7500	7875	8250	8625
3150	3600	4050	4500	4950	5400	5850	6300	6750	7200	7650	8100	8550	9000	9450	9900	10350
4830	5520	6210	6900	7590	8280	8970	9660	10350	11040	11730	12420	13110	13800	14490	15180	15870

For technical notes about pressure tables please refer to page 260.

## Industrial Tractors - T440 EXC - T480 EXC - T459

X-ply tires for agro industrial equipment



# T410

Excellent for both heavy duty agricultural and forestry applications. The Agro Forest line ensures good all-round performance in forestry usage as well as good traction, load capability and durability in agricultural operations.



SIZE	New tire		Tire in service		SLR mm	RC mm	SRI	Rims	Tube	Speed Km/h	PRESSURE	
	SW mm	OD mm	SW max mm	OD max mm							psi	bar
<b>320/85-24</b> 127A8 (124B) (12.4-24) <b>T410</b>	325	1165	345	1192	546	3462	550	W9-W10-W11	12.4-24	50 road <b>40 road</b> 30 road 10 road 10 HT	<b>MAX. LOAD kg</b>	

According to availability

SIZE	New tire		Tire in service		SLR mm	RC mm	SRI	Rims	Tube	Speed Km/h	PRESSURE	
	SW mm	OD mm	SW max mm	OD max mm							psi	bar
<b>380/85-24</b> 137A8 (134B) (14.9-24) <b>T410</b>	380	1260	410	1302	583	3768	590	W11-W12-W13	14.9-24	50 road <b>40 road</b> 30 road 10 road 10 HT	<b>MAX. LOAD kg</b>	

SIZE	New tire		Tire in service		SLR mm	RC mm	SRI	Rims	Tube	Speed Km/h	PRESSURE	
	SW mm	OD mm	SW max mm	OD max mm							psi	bar
<b>380/85-24 TL</b> 143A8 (140B) (14.9-24) <b>T410</b>	390	1275	410	1302	600	3810	600	W11-W12-W13	14.9-24	50 road <b>40 road</b> 30 road 10 road 10 HT	<b>MAX. LOAD kg</b>	

SIZE	New tire		Tire in service		SLR mm	RC mm	SRI	Rims	Tube	Speed Km/h	PRESSURE	
	SW mm	OD mm	SW max mm	OD max mm							psi	bar
<b>380/85-28</b> 139A8 (136B) (14.9-28) <b>T410</b>	380	1365	410	1403	637	4071	650	W11-W12-W13	14.9-28	50 road <b>40 road</b> 30 road 10 road 10 HT	<b>MAX. LOAD kg</b>	

SIZE	New tire		Tire in service		SLR mm	RC mm	SRI	Rims	Tube	Speed Km/h	PRESSURE	
	SW mm	OD mm	SW max mm	OD max mm							psi	bar
<b>420/85-28</b> 144A8 (141B) (16.9-28) <b>T410</b>	440	1435	451	1475	669	4275	675	W13-W14L <b>W15L</b>	16.9-28	50 road <b>40 road</b> 30 road 10 road 10 HT	<b>MAX. LOAD kg</b>	



SIZE	
<b>320/85-24</b>	<b>127A8 (124B)</b>
<b>380/85-24</b>	<b>137A8 (134B)</b>
<b>380/85-24 TL</b>	<b>143A8 (140B)</b>
<b>380/85-28</b>	<b>139A8 (136B)</b>
<b>420/85-28</b>	<b>144A8 (141B)</b>
<b>460/85-30</b>	<b>150A8 (147B)</b>

SIZE	
<b>420/85-34</b>	<b>147A8 (144B)</b>
<b>420/85-34 TL</b>	<b>153A8 (150B)</b>
<b>460/85-34</b>	<b>152A8 (149B)</b>
<b>420/85-38</b>	<b>149A8 (146B)</b>
<b>460/85-38</b>	<b>154A8 (151B)</b>
<b>520/85-38</b>	<b>160A8 (157B)</b>

14	17	20	23	25	26	28	29	30	32	33	35	36	38	39	41	42	43
1,0	1,2	1,4	1,6	1,7	1,8	1,9	2,0	2,1	2,2	2,3	2,4	2,5	2,6	2,7	2,8	2,9	3,0
1000	1120	1240	1360	1395	1435	1465	1495	1525	1555	1580	1600						
1085	1215	1355	1500	1540	1575	1610	1645	1675	1700	1725	<b>1750</b>						
1160	1300	1450	1605	1650	1685	1725	1760	1790	1820	1850	1875						
1425	1585	1745	1910	1995	2075	2165	2250	2290	2325	2405	2440	2470	2495	2515	2590	2610	2625
950	1065	1190	1315	1350	1385	1415	1445	1470	1495	1515	1535	1575	1610	1645	1680	1710	1745

14	17	20	23	25	26	28	29	30	32	33	35	36	38	39	41	42	43
1,0	1,2	1,4	1,6	1,7	1,8	1,9	2,0	2,1	2,2	2,3	2,4	2,5	2,6	2,7	2,8	2,9	3,0
1285	1450	1600	1750	1800	1850	1900	1945	1985	2025	2060	2120						
1425	1600	1775	1950	2000	2050	2095	2140	2175	2215	2245	<b>2300</b>						
1525	1710	1900	2085	2140	2195	2245	2290	2330	2370	2405	2460						
1875	2085	2295	2505	2610	2715	2820	2925	2975	3025	3130	3170	3205	3240	3275	3370	3395	3415
1250	1405	1560	1710	1755	1800	1840	1875	1910	1940	1970	1995	2050	2100	2150	2200	2250	2300

14	17	20	23	26	29	32	35	38	41	44	46	49	52	55	58
1,0	1,2	1,4	1,6	1,8	2,0	2,2	2,4	2,6	2,8	3,0	3,2	3,4	3,6	3,8	4,0
1285	1450	1600	1750	1850	1945	2025	2120	2200	2295	2390	2500				
1425	1600	1775	1950	2050	2140	2215	2300	2390	2500	2600	<b>2725</b>				
1525	1710	1900	2085	2195	2290	2370	2460	2555	2675	2785	2915				
1875	2085	2295	2505	2715	2925	3025	3170	3240	3370	3415	3540	3690	3805	3945	4050
1250	1405	1560	1710	1800	1875	1940	1995	2095	2190	2285	2370	2455	2540	2620	2700

14	17	20	23	25	26	28	29	30	32	33	35	36	38	39	41	42	43
1,0	1,2	1,4	1,6	1,7	1,8	1,9	2,0	2,1	2,2	2,3	2,4	2,5	2,6	2,7	2,8	2,9	3,0
1385	1550	1725	1900	1955	2005	2050	2095	2135	2170	2205	2240						
1510	1700	1880	2060	2115	2170	2220	2270	2315	2355	2395	<b>2430</b>						
1615	1820	2015	2205	2265	2325	2380	2430	2475	2520	2565	2600						
1980	2210	2435	2655	2765	2875	2985	3090	3150	3205	3310	3360	3405	3445	3485	3585	3615	3645
1325	1490	1650	1810	1860	1905	1950	1990	2030	2070	2100	2135	2190	2240	2295	2350	2400	2450

14	17	20	23	25	26	28	29	30	32	33	35	36	38	39	41	42	43
1,0	1,2	1,4	1,6	1,7	1,8	1,9	2,0	2,1	2,2	2,3	2,4	2,5	2,6	2,7	2,8	2,9	3,0
1600	1800	2020	2240	2295	2345	2395	2440	2480	2515	2545	2575						
1775	2000	2215	2430	2490	2550	2600	2650	2695	2735	2770	<b>2800</b>						
1900	2140	2370	2600	2665	2725	2785	2835	2880	2925	2965	2995						
2325	2595	2865	3130	3255	3390	3520	3645	3705	3760	3885	3930	3975	4010	4040	4160	4180	4200
1555	1755	1945	2135	2185	2235	2285	2325	2365	2400	2430	2455	2520	2585	2645	2705	2765	2825

### Agro Forest: T410

X-ply tire for forestry equipment



SIZE	New tire		Tire in service		SLR mm	RC mm	SRI	Rims	Tube	Speed Km/h	PRESSURE	
	SW mm	OD mm	SW max mm	OD max mm							psi	bar
<b>460/85-30</b> 150A8 (147B) (18.4-30) <b>T410</b>	480	1550	491	1598	720	4632	725	W14L-W15L <b>W16L</b>	18.4-30	50 road <b>40 road</b> 30 road 10 road 10 HT		

SIZE	New tire		Tire in service		SLR mm	RC mm	SRI	Rims	Tube	Speed Km/h	PRESSURE	
	SW mm	OD mm	SW max mm	OD max mm							psi	bar
<b>420/85-34</b> 147A8 (144B) (16.9-34) <b>T410</b>	440	1575	451	1628	736	4734	750	W13L-W14L <b>W15L</b>	16.9-34	50 road <b>40 road</b> 30 road 10 road 10 HT		

According to availability

SIZE	New tire		Tire in service		SLR mm	RC mm	SRI	Rims	Tube	Speed Km/h	PRESSURE	
	SW mm	OD mm	SW max mm	OD max mm							psi	bar
<b>420/85-34 TL</b> 153A8 (150B) (16.9-34) <b>T410</b>	445	1575	460	1628	736	4734	750	W13L-W14L <b>W15L</b>	16.9-34	50 road <b>40 road</b> 30 road 10 road 10 HT		

SIZE	New tire		Tire in service		SLR mm	RC mm	SRI	Rims	Tube	Speed Km/h	PRESSURE	
	SW mm	OD mm	SW max mm	OD max mm							psi	bar
<b>460/85-34</b> 152A8 (149B) (18.4-34) <b>T410</b>	475	1645	491	1700	766	4938	775	W14L-W15L <b>W16L</b>	18.4-34	50 road <b>40 road</b> 30 road 10 road 10 HT		

SIZE	New tire		Tire in service		SLR mm	RC mm	SRI	Rims	Tube	Speed Km/h	PRESSURE	
	SW mm	OD mm	SW max mm	OD max mm							psi	bar
<b>420/85-38</b> 149A8 (146B) (16.9-38) <b>T410</b>	440	1680	451	1729	787	5037	800	W13-W14L <b>W15L</b>	16.9-38	50 road <b>40 road</b> 30 road 10 road 10 HT		

SIZE	New tire		Tire in service		SLR mm	RC mm	SRI	Rims	Tube	Speed Km/h	PRESSURE	
	SW mm	OD mm	SW max mm	OD max mm							psi	bar
<b>460/85-38</b> 154A8 (151B) (18.4-38) <b>T410</b>	470	1750	491	1801	819	5241	825	W14-W15L <b>W16L</b>	18.4-38	50 road <b>40 road</b> 30 road 10 road 10 HT		

SIZE	New tire		Tire in service		SLR mm	RC mm	SRI	Rims	Tube	Speed Km/h	PRESSURE	
	SW mm	OD mm	SW max mm	OD max mm							psi	bar
<b>520/85-38</b> 160A8 (157B) (20.8-38) <b>T410</b>	520	1850	557	1911	859	5547	875	<b>DW16L-DW18L</b>	20.8-38	50 road <b>40 road</b> 30 road 10 road 10 HT		

14	17	20	23	25	26	28	29	30	32	33	35	36	38	39	41	42	43
1,0	1,2	1,4	1,6	1,7	1,8	1,9	2,0	2,1	2,2	2,3	2,4	2,5	2,6	2,7	2,8	2,9	3,0
1940	2180	2415	2650	2720	2785	2845	2900	2950	2995	3035	3075						
2105	2360	2630	2900	2975	3045	3105	3165	3220	3270	3310	<b>3350</b>						
2255	2525	2815	3105	3180	3255	3325	3385	3445	3495	3545	3585						
2775	3080	3390	3705	3865	4025	4185	4350	4420	4490	4640	4700	4750	4795	4830	4970	5000	5025
1850	2070	2310	2545	2610	2670	2725	2780	2825	2870	2905	2940	3015	3090	3165	3235	3305	3375

14	17	20	23	25	26	28	29	30	32	33	35	36	38	39	41	42	43
1,0	1,2	1,4	1,6	1,7	1,8	1,9	2,0	2,1	2,2	2,3	2,4	2,5	2,6	2,7	2,8	2,9	3,0
1775	2000	2215	2430	2490	2550	2600	2650	2695	2735	2770	2800						
1940	2180	2415	2650	2720	2785	2845	2900	2950	2995	3035	<b>3075</b>						
2075	2335	2585	2835	2910	2980	3040	3100	3155	3205	3250	3290						
2550	2840	3130	3410	3550	3695	3835	3975	4045	4105	4245	4300	4345	4390	4430	4555	4585	4615
1705	1915	2120	2325	2385	2440	2495	2545	2590	2630	2665	2700	2765	2835	2900	2960	3025	3085

14	17	20	23	26	29	32	35	38	41	44	46	49	52	55	58
1,0	1,2	1,4	1,6	1,8	2,0	2,2	2,4	2,6	2,8	3,0	3,2	3,4	3,6	3,8	4,0
1775	2000	2215	2430	2550	2650	2735	2800	2945	3085	3220	3350				
1940	2180	2415	2650	2785	2900	2995	3075	3230	3375	3515	<b>3650</b>				
2075	2335	2585	2835	2980	3100	3205	3290	3455	3610	3760	3905				
2550	2840	3130	3410	3695	3975	4105	4300	4390	4555	4615	4780	4985	5140	5335	5475
1705	1915	2120	2325	2440	2545	2630	2700	2835	2960	3085	3205	3320	3430	3540	3650

14	17	20	23	25	26	28	29	30	32	33	35	36	38	39	41	42	43
1,0	1,2	1,4	1,6	1,7	1,8	1,9	2,0	2,1	2,2	2,3	2,4	2,5	2,6	2,7	2,8	2,9	3,0
2020	2300	2550	2800	2870	2940	3005	3060	3115	3165	3210	3250						
2225	2500	2785	3075	3155	3225	3295	3355	3410	3465	3510	<b>3550</b>						
2380	2675	2980	3290	3375	3450	3525	3590	3650	3705	3755	3800						
2925	3255	3585	3925	4095	4255	4440	4615	4690	4760	4920	4980	5035	5080	5120	5270	5300	5325
1955	2195	2445	2700	2765	2830	2890	2945	2995	3040	3080	3115	3195	3275	3355	3435	3510	3585

14	17	20	23	25	26	28	29	30	32	33	35	36	38	39	41	42	43
1,0	1,2	1,4	1,6	1,7	1,8	1,9	2,0	2,1	2,2	2,3	2,4	2,5	2,6	2,7	2,8	2,9	3,0
1885	2120	2350	2575	2645	2705	2765	2820	2870	2920	2960	3000						
2050	2300	2550	2800	2875	2940	3005	3065	3115	3165	3210	<b>3250</b>						
2195	2460	2730	2995	3075	3145	3215	3275	3335	3390	3435	3480						
2700	3000	3300	3600	3750	3905	4050	4200	4270	4340	4485	4540	4595	4640	4680	4815	4850	4875
1800	2020	2240	2455	2520	2580	2635	2690	2735	2780	2815	2850	2925	3000	3070	3135	3205	3270

14	17	20	23	25	26	28	29	30	32	33	35	36	38	39	41	42	43
1,0	1,2	1,4	1,6	1,7	1,8	1,9	2,0	2,1	2,2	2,3	2,4	2,5	2,6	2,7	2,8	2,9	3,0
2135	2430	2670	2900	2985	3065	3140	3210	3275	3340	3395	3450						
2355	2650	2950	3250	3330	3410	3480	3545	3605	3660	3710	<b>3750</b>						
2520	2835	3155	3480	3565	3650	3725	3795	3855	3915	3970	4015						
3090	3445	3800	4155	4335	4510	4695	4875	4955	5030	5200	5260	5320	5370	5410	5570	5600	5625
2065	2325	2590	2850	2925	2990	3055	3110	3165	3210	3255	3290	3380	3465	3550	3630	3715	3795

14	17	20	23	25	26	28	29	30	32	33	35	36	38	39	41	42	43
1,0	1,2	1,4	1,6	1,7	1,8	1,9	2,0	2,1	2,2	2,3	2,4	2,5	2,6	2,7	2,8	2,9	3,0
2570	2900	3225	3550	3645	3730	3810	3885	3955	4015	4075	4125						
2830	3150	3510	3875	3975	4070	4160	4240	4315	4385	4445	<b>4500</b>						
3025	3370	3755	4145	4255	4355	4450	4535	4615	4690	4755	4815						
3750	4135	4540	4945	5160	5375	5590	5815	5915	6005	6205	6290	6360	6425	6480	6670	6715	6750
2485	2765	3080	3400	3490	3575	3650	3720	3785	3845	3900	3950	4060	4165	4275	4380	4480	4585

For technical notes about pressure tables please refer to page 260.

## Agro Forest: T410

X-ply tire for forestry equipment



**T440**



**T480**



**T428**



**T421**



**T414**



**T404**



Designed to offer superior performance in the forest, they ensure high traction, excellent flotation and low damage to the soil structure.

### T440

T440 takes exclusive Trelleborg ProgressiveTraction® on board for the best grip on the ground. The well known Trelleborg concept of inter-lug terraces has also been added, keeping the tread clean. Lug heads and shoulders are now heavier, making your T440 an even better match for tracks.

### T480

The T480's transverse grooves and wide flat tire profile give it unmatched track grip and compatibility. Even without tracks, you'll experience unmatched pulling power in every condition.

Moreover the inter-lug terraces boost the tire self-cleaning so that it can always work harder and push further.

### T428

Designed to provide excellent pull force in tough, clayey terrain as well as on ice and snow, either with or without the assistance of tracks and chains. The load is spread across a large contact area, which gives the tire a low ground bearing pressure and puts minimum strain on the vehicle.

SIZE			
600/50-22.5 LS2	149A8	T480	SB
650/45-22.5 LS2	150A8	T440	SB
710/40-22.5 LS2	161A8	T480	SB
710/40-24.5 LS2	163A8	T440	SB
710/40-24.5 LS2	163A8	T480	SB
600/55-26.5 LS2	165A8	T440	SB
600/55-26.5 LS2	165A8	T480	SB
710/45-26.5 LS2	168A8	T440	SB
710/45-26.5 LS2	168A8	T480	SB
710/45-26.5 LS2	173A8	T480	SB
750/55-26.5 LS2	182A8	T440	SB
750/55-26.5 LS2	182A8	T480	SB
800/40-26.5 LS2	170A8	T440	SB
800/40-26.5 LS2	170A8	T480	SB
780/50-28.5 LS2	182A8	T480	SB

SIZE			
750/45-30.5 LS2	173A8	T428	SB
600/65-34 LS2	163A8	T440	SB
710/55-34 LS2	167A8	T440	SB

SIZE			
Tires for all-round service			
600/60-30.5	153A8	T414	

SIZE			
Driving tires for single axle fitment			
500/45-22.5	129A8	T404	
500/60-22.5	144A8	T421	SB



SIZE	LI/SI			New tire		Tire in service		SLR mm	RC mm	SRI	Rim	Tube
	ROAD	FOREST HT	FOREST LT	SW mm	OD mm	SW max mm	OD max mm					
<b>600/50-22.5 LS2</b> <b>T480 SB</b>	149A8	149A2	156A2	610	1170	640	1199	550	3510	550	AG20.00	600/50-22.5

SIZE	LI/SI			New tire		Tire in service		SLR mm	RC mm	SRI	Rim	Tube
	ROAD	FOREST HT	FOREST LT	SW mm	OD mm	SW max mm	OD max mm					
<b>650/45-22.5 LS2</b> <b>T440 SB</b>	150A8	150A2	157A2	650	1160	683	1189	539		550	AG20.00	650/45-22.5

SIZE	LI/SI			New tire		Tire in service		SLR mm	RC mm	SRI	Rim	Tube
	ROAD	FOREST HT	FOREST LT	SW mm	OD mm	SW max mm	OD max mm					
<b>710/40-22.5 LS2</b> <b>T480 SB</b>	161A8	161A2	169A2	710	1170	746	1179	540	3510	550	AG24.00	700/40-22.5

SIZE	LI/SI			New tire		Tire in service		SLR mm	RC mm	SRI	Rim	Tube
	ROAD	FOREST HT	FOREST LT	SW mm	OD mm	SW max mm	OD max mm					
<b>710/40-24.5 LS2</b> <b>T440 SB</b>	163A8	163A2	170A2	710	1220	745	1230	570	3700	575	AG24.00	710/40-24.5

SIZE	LI/SI			New tire		Tire in service		SLR mm	RC mm	SRI	Rim	Tube
	ROAD	FOREST HT	FOREST LT	SW mm	OD mm	SW max mm	OD max mm					
<b>710/40-24.5 LS2</b> <b>T480 SB</b>	163A8	163A2	170A2	710	1220	745	1230	570	3700	575	AG24.00	710/40-24.5

Speed Km/h	PRESSURE												* Infl. Pressure with tracks Bar	
	psi	23	29	35	39	43	46	51	55	58	61	65		
	bar	1,6	2,0	2,4	2,7	3,0	3,2	3,5	3,8	4,0	4,2	4,5		
	MAX. LOAD kg													
<b>40 road</b>		2120	2435	2725	2930	3125	<b>3250</b>							5,0
10HT light terrain		2535	2965	3325	3565	3815	3960	4195	4425	4550				5,0
<b>10HT heavy terrain</b>		2120	2435	2725	2930	3125	<b>3250</b>							5,0
10HT very heavy terrain		1680	1955	2215	2385	2550	2640	2795	2945	3025	3125	3260		5,0
10LT light terrain		3080	3605	4060	4365	4690	4870	5165	5445	5600				5,0
<b>10LT heavy terrain</b>		2575	2975	3350	3605	3845	<b>4000</b>							5,0
10LT very heavy terrain		2040	2375	2695	2910	3120	3240	3435	3620	3720	3845	4015		5,0

Speed Km/h	PRESSURE												* Infl. Pressure with tracks Bar	
	psi	23	29	35	39	43	46	51	55	58	61	65		
	bar	1,6	2,0	2,4	2,7	3,0	3,2	3,5	3,8	4,0	4,2	4,5		
	MAX. LOAD kg													
<b>40 road</b>		2180	2500	2800	3015	3220	<b>3350</b>							5,0
10HT light terrain		2610	3050	3420	3660	3920	4070	4320	4560	4690				5,0
<b>10HT heavy terrain</b>		2180	2500	2800	3015	3220	<b>3350</b>							5,0
10HT very heavy terrain		2100	2445	2770	2995	3210	3340	3540	3730	3835	3965	4140		5,0
10LT light terrain		3170	3710	4175	4495	4830	5015	5320	5615	5775				5,0
<b>10LT heavy terrain</b>		2650	3060	3450	3715	3965	<b>4125</b>							5,0
10LT very heavy terrain		1725	2010	2275	2450	2620	2715	2875	3030	3115	3220	3360		5,0

Speed Km/h	PRESSURE														* Infl. Pressure with tracks Bar				
	psi	23	29	35	39	43	46	51	55	58	61	65	68	72		75	78	81	
	bar	1,6	2,0	2,4	2,7	3,0	3,2	3,5	3,8	4,0	4,2	4,5	4,7	5,0		5,2	5,4	5,6	
	MAX. LOAD kg																		
<b>40 road</b>		2240	2580	2900	3120	3320	3450	3705	3960	4125	4235	4395	4490	<b>4625</b>					6,0
10HT light terrain		2680	3135	3525	3785	4060	4210	4460	4700	4830	5020	5305	5490	5775	5880	5980	6075		6,0
<b>10HT heavy terrain</b>		2240	2580	2900	3120	3320	3450	3705	3960	4125	4235	4395	4490	<b>4625</b>					6,0
10HT very heavy terrain		1775	2065	2340	2525	2705	2810	2975	3130	3215	3320	3465	3580	3765	3885	4005	4125		6,0
10LT light terrain		3350	3920	4370	4660	4970	5165	5480	5780	5950	6200	6580	6830	7210	7350	7480	7605		6,0
<b>10LT heavy terrain</b>		2800	3195	3550	3825	4085	4250	4590	4925	5150	5295	5495	5625	<b>5800</b>					6,0
10LT very heavy terrain		2220	2580	2920	3135	3335	3445	3645	3840	3950	4085	4265	4425	4670	4830	4990	5150		6,0

Speed Km/h	PRESSURE														* Infl. Pressure with tracks Bar				
	psi	23	29	35	39	43	46	51	55	58	61	65	68	72		75	78	81	
	bar	1,6	2,0	2,4	2,7	3,0	3,2	3,5	3,8	4,0	4,2	4,5	4,7	5,0		5,2	5,4	5,6	
	MAX. LOAD kg																		
<b>40 road</b>		2360	2695	3000	3220	3420	3550	3815	4075	4250	4385	4575	4700	<b>4875</b>					6,0
10HT light terrain		2825	3305	3690	3935	4200	4350	4605	4845	4970	5165	5460	5655	5950	6085	6215	6345		6,0
<b>10HT heavy terrain</b>		2360	2695	3000	3220	3420	3550	3815	4075	4250	4385	4575	4700	<b>4875</b>					6,0
10HT very heavy terrain		1870	2175	2460	2645	2815	2910	3075	3230	3315	3420	3565	3685	3875	4000	4125	4250		6,0
10LT light terrain		3470	4060	4515	4800	5110	5310	5635	5950	6125	6385	6770	7030	7420	7570	7715	7850		6,0
<b>10LT heavy terrain</b>		2900	3295	3650	3935	4205	4375	4720	5070	5300	5455	5670	5805	<b>6000</b>					6,0
10LT very heavy terrain		2300	2675	3020	3235	3440	3550	3745	3950	4065	4205	4390	4555	4805	4970	5135	5300		6,0

Speed Km/h	PRESSURE														* Infl. Pressure with tracks Bar				
	psi	23	29	35	39	43	46	51	55	58	61	65	68	72		75	78	81	
	bar	1,6	2,0	2,4	2,7	3,0	3,2	3,5	3,8	4,0	4,2	4,5	4,7	5,0		5,2	5,4	5,6	
	MAX. LOAD kg																		
<b>40 road</b>		2360	2695	3000	3220	3420	3550	3815	4075	4250	4385	4575	4700	<b>4875</b>					6,0
10HT light terrain		2825	3305	3690	3935	4200	4350	4605	4845	4970	5165	5460	5655	5950	6085	6215	6345		6,0
<b>10HT heavy terrain</b>		2360	2695	3000	3220	3420	3550	3815	4075	4250	4385	4575	4700	<b>4875</b>					6,0
10HT very heavy terrain		1870	2175	2460	2645	2815	2910	3075	3230	3315	3420	3565	3685	3875	4000	4125	4250		6,0
10LT light terrain		3470	4060	4515	4800	5110	5310	5635	5950	6125	6385	6770	7030	7420	7570	7715	7850		6,0
<b>10LT heavy terrain</b>		2900	3295	3650	3935	4205	4375	4720	5070	5300	5455	5670	5805	<b>6000</b>					6,0
10LT very heavy terrain		2300	2675	3020	3235	3440	3550	3745	3950	4065	4205	4390	4555	4805	4970	5135	5300		6,0

## Twin Forestry - T404 - T414 - T421 SB - T428 SB - T440 - T480

X-ply tires for forestry equipment



SIZE	LI/SI			New tire		Tire in service		SLR mm	RC mm	SRI	Rim	Tube
	ROAD	FOREST HT	FOREST LT	SW mm	OD mm	SW max mm	OD max mm					
<b>600/55-26.5 LS2 T440 SB</b>	165A8	165A2	172A2	600	1340	630	1373	626	4050	625	AG20.00	600/55-26.5

SIZE	LI/SI			New tire		Tire in service		SLR mm	RC mm	SRI	Rim	Tube
	ROAD	FOREST HT	FOREST LT	SW mm	OD mm	SW max mm	OD max mm					
<b>600/55-26.5 LS2 T480 SB</b>	172A2	165A2	165A2	600	1340	630	1373	626	4050	625	AG20.00	600/55-26.5

SIZE	LI/SI			New tire		Tire in service		SLR mm	RC mm	SRI	Rim	Tube
	ROAD	FOREST HT	FOREST LT	SW mm	OD mm	SW max mm	OD max mm					
<b>710/45-26.5 LS2 T440 SB</b>	168A8	168A2	175A2	710	1340	746	1357	625	4020	625	AG24.00	710/45-26.5 / 750/50-26.5

SIZE	LI/SI			New tire		Tire in service		SLR mm	RC mm	SRI	Rim	Tube
	ROAD	FOREST HT	FOREST LT	SW mm	OD mm	SW max mm	OD max mm					
<b>710/45-26.5 LS2 T480 SB</b>	168A8	168A2	175A2	710	1340	746	1357	625	4020	625	AG24.00	710/45-26.5 / 750/50-26.5

SIZE	LI/SI			New tire		Tire in service		SLR mm	RC mm	SRI	Rim	Tube
	ROAD	FOREST HT	FOREST LT	SW mm	OD mm	SW max mm	OD max mm					
<b>710/45-26.5 LS2 T480 SB</b>	173A8	173A2	180A2	710	1340	746	1357	625	4020	625	AG24.00	710/45-26.5 / 750/50-26.5



Speed Km/h	PRESSURE																* Infl. Pressure with tracks Bar	
	psi	23	29	35	39	43	46	51	55	58	61	65	68	72	75	78		81
	bar	1,6	2,0	2,4	2,7	3,0	3,2	3,5	3,8	4,0	4,2	4,5	4,7	5,0	5,2	5,4		5,6
	MAX. LOAD kg																	
<b>40 road</b>	2500 2840 3150 3385 3610 3750 4035 4315 4500 4640 4840 4965 <b>5150</b>																6,0	
10HT light terrain	2990 3500 3895 4140 4410 4575 4850 5110 5250 5460 5775 5985 6300 6440 6575 6705																6,0	
<b>10HT heavy terrain</b>	2500 2840 3150 3385 3610 3750 4035 4315 4500 4640 4840 4965 <b>5150</b>																6,0	
10HT very heavy terrain	1980 2305 2605 2790 2970 3060 3230 3400 3495 3610 3765 3895 4100 4235 4365 4500																6,0	
10LT light terrain	3680 4305 4790 5095 5425 5630 5970 6300 6475 6705 7060 7280 7630 7815 7995 8170																6,0	
<b>10LT heavy terrain</b>	3075 3495 3875 4170 4450 4625 4940 5250 5450 5630 5890 6060 <b>6300</b>																6,0	
10LT very heavy terrain	2435 2835 3205 3435 3650 3765 3975 4190 4305 4450 4645 4785 5010 5165 5300 5450																6,0	

Speed Km/h	PRESSURE																* Infl. Pressure with tracks Bar	
	psi	23	29	35	39	43	46	51	55	58	61	65	68	72	75	78		81
	bar	1,6	2,0	2,4	2,7	3,0	3,2	3,5	3,8	4,0	4,2	4,5	4,7	5,0	5,2	5,4		5,6
	MAX. LOAD kg																	
<b>40 road</b>	2500 2840 3150 3385 3610 3750 4035 4315 4500 4640 4840 4965 <b>5150</b>																6,0	
10HT light terrain	2990 3500 3895 4140 4410 4575 4850 5110 5250 5460 5775 5985 6300 6440 6575 6705																6,0	
<b>10HT heavy terrain</b>	2500 2840 3150 3385 3610 3750 4035 4315 4500 4640 4840 4965 <b>5150</b>																6,0	
10HT very heavy terrain	1980 2305 2605 2790 2970 3060 3230 3400 3495 3610 3765 3895 4100 4235 4365 4500																6,0	
10LT light terrain	3680 4305 4790 5095 5425 5630 5970 6300 6475 6705 7060 7280 7630 7815 7995 8170																6,0	
<b>10LT heavy terrain</b>	3075 3495 3875 4170 4450 4625 4940 5250 5450 5630 5890 6060 <b>6300</b>																6,0	
10LT very heavy terrain	2435 2835 3205 3435 3650 3765 3975 4190 4305 4450 4645 4785 5010 5165 5300 5450																6,0	

Speed Km/h	PRESSURE																* Infl. Pressure with tracks Bar	
	psi	23	29	35	39	43	46	51	55	58	61	65	68	72	75	78		81
	bar	1,6	2,0	2,4	2,7	3,0	3,2	3,5	3,8	4,0	4,2	4,5	4,7	5,0	5,2	5,4		5,6
	MAX. LOAD kg																	
<b>40 road</b>	2725 3105 3450 3715 3965 4125 4410 4690 4875 5030 5255 5395 <b>5600</b>																6,0	
10HT light terrain	3260 3815 4255 4530 4830 5015 5320 5615 5775 5980 6305 6510 6825 6985 7135 7280																6,0	
<b>10HT heavy terrain</b>	2725 3105 3450 3715 3965 4125 4410 4690 4875 5030 5255 5395 <b>5600</b>																6,0	
10HT very heavy terrain	2160 2515 2840 3050 3245 3350 3540 3730 3835 3965 4140 4270 4475 4615 4740 4875																6,0	
10LT light terrain	4010 4690 5230 5575 5950 6155 6505 6835 7000 7280 7705 7980 8400 8595 8785 8970																6,0	
<b>10LT heavy terrain</b>	3350 3820 4250 4550 4830 5000 5375 5750 6000 6190 6470 6645 <b>6900</b>																6,0	
10LT very heavy terrain	2655 3090 3495 3750 3995 4125 4350 4570 4680 4830 5020 5195 5465 5645 5820 6000																6,0	

Speed Km/h	PRESSURE																* Infl. Pressure with tracks Bar	
	psi	23	29	35	39	43	46	51	55	58	61	65	68	72	75	78		81
	bar	1,6	2,0	2,4	2,7	3,0	3,2	3,5	3,8	4,0	4,2	4,5	4,7	5,0	5,2	5,4		5,6
	MAX. LOAD kg																	
<b>40 road</b>	2725 3105 3450 3715 3965 4125 4410 4690 4875 5030 5255 5395 <b>5600</b>																6,0	
10HT light terrain	3260 3815 4255 4530 4830 5015 5320 5615 5775 5980 6305 6510 6825 6985 7135 7280																6,0	
<b>10HT heavy terrain</b>	2725 3105 3450 3715 3965 4125 4410 4690 4875 5030 5255 5395 <b>5600</b>																6,0	
10HT very heavy terrain	2160 2515 2840 3050 3245 3350 3540 3730 3835 3965 4140 4270 4475 4615 4740 4875																6,0	
10LT light terrain	4010 4690 5230 5575 5950 6155 6505 6835 7000 7280 7705 7980 8400 8595 8785 8970																6,0	
<b>10LT heavy terrain</b>	3350 3820 4250 4550 4830 5000 5375 5750 6000 6190 6470 6645 <b>6900</b>																6,0	
10LT very heavy terrain	2655 3090 3495 3750 3995 4125 4350 4570 4680 4830 5020 5195 5465 5645 5820 6000																6,0	

Speed Km/h	PRESSURE																* Infl. Pressure with tracks Bar			
	psi	23	28	34	39	43	46	50	55	57	60	64	67	72	75	77		80	84	87
	bar	1,6	2,0	2,4	2,7	3,0	3,2	3,5	3,8	4,0	4,2	4,5	4,7	5,0	5,2	5,4		5,6	5,8	6,0
	MAX. LOAD kg																			
<b>40 road</b>	2725 3105 3450 3715 3965 4125 4410 4690 4875 5030 5255 5395 5600 5785 5965 6145 6320 <b>6500</b>																6,0			
10HT light terrain	3260 3815 4255 4530 4830 5015 5320 5615 5775 5980 6305 6510 6825 6985 7135 7280 7425 7560																6,0			
<b>10HT heavy terrain</b>	2725 3105 3450 3715 3965 4125 4410 4690 4875 5030 5255 5395 5600 5785 5965 6145 6320 <b>6500</b>																6,0			
10HT very heavy terrain	2160 2515 2840 3050 3245 3350 3540 3730 3835 3965 4140 4270 4475 4615 4740 4875 4970 5060																6,0			
10LT light terrain	4010 4690 5230 5575 5950 6155 6505 6835 7000 7280 7705 7980 8400 8595 8785 8970 9145 9315																6,0			
<b>10LT heavy terrain</b>	3350 3820 4250 4550 4830 5000 5375 5750 6000 6190 6470 6645 6900 7125 7345 7565 7785 <b>8000</b>																6,0			
10LT very heavy terrain	2655 3090 3495 3750 3995 4125 4350 4570 4680 4830 5020 5195 5465 5645 5820 6000 6120 6230																6,0			

## Twin Forestry - T404 - T414 - T421 SB - T428 SB - T440 - T480

X-ply tires for forestry equipment



SIZE	LI/SI			New tire		Tire in service		SLR mm	RC mm	SRI	Rim	Tube
	ROAD	FOREST HT	FOREST LT	SW mm	OD mm	SW max mm	OD max mm					
<b>750/55-26.5</b> <b>T440 SB</b>	182A8	182A2	190A2	750	1485	788	1499	690	4485	700	AG24.00	710/45-26.5 / 750/50-26.5

SIZE	LI/SI			New tire		Tire in service		SLR mm	RC mm	SRI	Rim	Tube
	ROAD	FOREST HT	FOREST LT	SW mm	OD mm	SW max mm	OD max mm					
<b>750/55-26.5</b> <b>T480 SB</b>	182A8	182A2	190A2	750	1485	788	1499	690	4485	700	AG24.00	710/45-26.5 / 750/50-26.5

SIZE	LI/SI			New tire		Tire in service		SLR mm	RC mm	SRI	Rim	Tube
	ROAD	FOREST HT	FOREST LT	SW mm	OD mm	SW max mm	OD max mm					
<b>800/40-26.5</b> <b>T440 SB</b>	170A8	170A2	177A2	800	1340	840	1357	625	4020	625	AG28.00	800/40-26.5

SIZE	LI/SI			New tire		Tire in service		SLR mm	RC mm	SRI	Rim	Tube
	ROAD	FOREST HT	FOREST LT	SW mm	OD mm	SW max mm	OD max mm					
<b>800/40-26.5</b> <b>T480 SB</b>	170A8	170A2	177A2	800	1340	840	1357	625	4020	625	AG28.00	800/40-26.5

SIZE	LI/SI			New tire		Tire in service		SLR mm	RC mm	SRI	Rim	Tube
	ROAD	FOREST HT	FOREST LT	SW mm	OD mm	SW max mm	OD max mm					
<b>780/50-28.5</b> <b>T480 SB</b>	182A8	182A8	190A2	780	1525	819	1543	705	4660	725	AG26.00	780/50-28.5 710/55-28.5

Speed Km/h	PRESSURE																* Infl. Pressure with tracks Bar			
	psi	23	28	34	39	43	46	50	55	57	60	64	67	72	75	77		80	84	87
	bar	1,6	2,0	2,4	2,7	3,0	3,2	3,5	3,8	4,0	4,2	4,5	4,7	5,0	5,2	5,4		5,6	5,8	6,0
	MAX. LOAD kg																			
40 road	3550	4050	4500	4820	5115	5300	5700	6100	6365	6565	6850	7035	7300	7545	7785	8025	8265	<b>8500</b>	6,0	
10HT light terrain	4245	4970	5545	5905	6300	6520	6890	7240	7420	7715	8170	8460	8910	9115	9310	9500	9680	9855	6,0	
10HT heavy terrain	3550	4050	4500	4820	5115	5300	5700	6100	6365	6565	6850	7035	7300	7545	7785	8025	8265	<b>8500</b>	6,0	
10HT very heavy terrain	2815	3275	3700	3975	4230	4370	4610	4840	4960	5115	5320	5510	5795	5985	6175	6365	6485	6605	6,0	
10LT light terrain	5235	6125	6855	7330	7840	8085	8515	8915	9100	9470	10035	10405	10965	11220	11465	11700	11930	12150	6,0	
10LT heavy terrain	4375	5010	5600	5965	6300	6500	7000	7500	7835	8080	8440	8670	9000	9320	9640	9960	10280	<b>10600</b>	6,0	
10LT very heavy terrain	3465	4035	4565	4915	5245	5430	5725	5995	6115	6300	6525	6760	7120	7360	7595	7835	7985	8130	6,0	

Speed Km/h	PRESSURE																* Infl. Pressure with tracks Bar			
	psi	23	28	34	39	43	46	50	55	57	60	64	67	72	75	77		80	84	87
	bar	1,6	2,0	2,4	2,7	3,0	3,2	3,5	3,8	4,0	4,2	4,5	4,7	5,0	5,2	5,4		5,6	5,8	6,0
	MAX. LOAD kg																			
40 road	3550	4050	4500	4820	5115	5300	5700	6100	6365	6565	6850	7035	7300	7545	7785	8025	8265	<b>8500</b>	6,0	
10HT light terrain	4245	4970	5545	5905	6300	6520	6890	7240	7420	7715	8170	8460	8910	9115	9310	9500	9680	9855	6,0	
10HT heavy terrain	3550	4050	4500	4820	5115	5300	5700	6100	6365	6565	6850	7035	7300	7545	7785	8025	8265	<b>8500</b>	6,0	
10HT very heavy terrain	2815	3275	3700	3975	4230	4370	4610	4840	4960	5115	5320	5510	5795	5985	6175	6365	6485	6605	6,0	
10LT light terrain	5235	6125	6855	7330	7840	8085	8515	8915	9100	9470	10035	10405	10965	11220	11465	11700	11930	12150	6,0	
10LT heavy terrain	4375	5010	5600	5965	6300	6500	7000	7500	7835	8080	8440	8670	9000	9320	9640	9960	10280	<b>10600</b>	6,0	
10LT very heavy terrain	3465	4035	4565	4915	5245	5430	5725	5995	6115	6300	6525	6760	7120	7360	7595	7835	7985	8130	6,0	

Speed Km/h	PRESSURE																* Infl. Pressure with tracks Bar			
	psi	23	29	35	39	43	46	51	55	58	61	65	68	72	75	78		81		
	bar	1,6	2	2,4	2,7	3	3,2	3,5	3,8	4	4,2	4,5	4,7	5	5,2	5,4		5,6		
	MAX. LOAD kg																			
40 road	2900	3340	3750	4005	4235	4375	4720	5070	5300	5455	5670	5805	<b>6000</b>						6,0	
10HT light terrain	3470	4060	4560	4895	5250	5420	5715	5995	6125	6385	6770	7030	7420	7570	7715	7850			6,0	
10HT heavy terrain	2900	3340	3750	4005	4235	4375	4720	5070	5300	5455	5670	5805	<b>6000</b>						6,0	
10HT very heavy terrain	2300	2675	3030	3270	3500	3630	3835	4020	4110	4235	4390	4555	4805	4970	5135	5300			6,0	
10LT light terrain	4365	5110	5700	6070	6475	6700	7080	7445	7630	7920	8370	8660	9100	9270	9430	9585			6,0	
10LT heavy terrain	3650	4160	4625	4955	5260	5450	5850	6240	6500	6680	6925	7085	<b>7300</b>						6,0	
10LT very heavy terrain	2890	3365	3805	4085	4350	4490	4735	4975	5095	5260	5470	5655	5940	6130	6310	6500			6,0	

Speed Km/h	PRESSURE																* Infl. Pressure with tracks Bar			
	psi	23	29	35	39	43	46	51	55	58	61	65	68	72	75	78		81		
	bar	1,6	2	2,4	2,7	3	3,2	3,5	3,8	4	4,2	4,5	4,7	5	5,2	5,4		5,6		
	MAX. LOAD kg																			
40 road	2900	3340	3750	4005	4235	4375	4720	5070	5300	5455	5670	5805	<b>6000</b>						6,0	
10HT light terrain	3470	4060	4560	4895	5250	5420	5715	5995	6125	6385	6770	7030	7420	7570	7715	7850			6,0	
10HT heavy terrain	2900	3340	3750	4005	4235	4375	4720	5070	5300	5455	5670	5805	<b>6000</b>						6,0	
10HT very heavy terrain	2300	2675	3030	3270	3500	3630	3835	4020	4110	4235	4390	4555	4805	4970	5135	5300			6,0	
10LT light terrain	4365	5110	5700	6070	6475	6700	7080	7445	7630	7920	8370	8660	9100	9270	9430	9585			6,0	
10LT heavy terrain	3650	4160	4625	4955	5260	5450	5850	6240	6500	6680	6925	7085	<b>7300</b>						6,0	
10LT very heavy terrain	2890	3365	3805	4085	4350	4490	4735	4975	5095	5260	5470	5655	5940	6130	6310	6500			6,0	

Speed Km/h	PRESSURE																* Infl. Pressure with tracks Bar			
	psi	23	28	34	39	43	46	50	55	57	60	64	67	72	75	77		80	84	87
	bar	1,6	2,0	2,4	2,7	3,0	3,2	3,5	3,8	4,0	4,2	4,5	4,7	5,0	5,2	5,4		5,6	5,8	6,0
	MAX. LOAD kg																			
40 road	3550	4050	4500	4820	5115	5300	5715	6125	6400	6595	6875	7050	7300	7545	7785	8025	8265	<b>8500</b>	6,0	
10HT light terrain	4245	4970	5545	5905	6300	6520	6890	7240	7420	7730	8195	8500	8965	9155	9345	9520	9690	9855	6,0	
10HT heavy terrain	3550	4050	4500	4820	5115	5300	5715	6125	6400	6595	6875	7050	7300	7545	7785	8025	8265	<b>8500</b>	6,0	
10HT very heavy terrain	2810	3275	3700	3975	4230	4370	4610	4840	4960	5115	5320	5515	5810	6010	6205	6400	6515	6625	6,0	
10LT light terrain	5235	6125	6855	7330	7840	8085	8515	8915	9100	9485	10065	10450	11030	11275	11505	11730	11945	12150	6,0	
10LT heavy terrain	4375	5010	5600	5965	6300	6500	7015	7535	7880	8120	8465	8685	9000	9320	9640	9960	10280	<b>10600</b>	6,0	
10LT very heavy terrain	3465	4035	4565	4915	5245	5430	5725	5995	6115	6300	6525	6770	7140	7385	7635	7880	8025	8160	6,0	

## Twin Forestry - T404 - T414 - T421 SB - T428 SB - T440 - T480

X-ply tires for forestry equipment



SIZE	LI/SI			New tire		Tire in service		SLR mm	RC mm	SRI	Rim	Tube
	ROAD	FOREST HT	FOREST LT	SW mm	OD mm	SW max mm	OD max mm					
<b>750/45-30.5 LS2 T428 SB</b>	173A8	173A2	180A2	750	1465	788	1497	700	4395	685	AG24.00	710/50-30.5 / 750/45-30.5

SIZE	LI/SI			New tire		Tire in service		SLR mm	RC mm	SRI	Rim	Tube
	ROAD	FOREST HT	FOREST LT	SW mm	OD mm	SW max mm	OD max mm					
<b>600/65-34 LS2 T440 SB</b>	163A8	163A2	170A2	610	1650	630	1690	765	5070	775	DW20A	600/65-34

SIZE	LI/SI			New tire		Tire in service		SLR mm	RC mm	SRI	Rim	Tube
	ROAD	FOREST HT	FOREST LT	SW mm	OD mm	SW max mm	OD max mm					
<b>710/55-34 LS2 T440 SB</b>	167A8	167A2	174A2	710	1650	746	1691	775	4950	760	DW24A	700/55-34

Speed Km/h	PRESSURE																* Infl. Pressure with tracks Bar		
	psi	23	29	35	39	43	46	51	55	58	61	65	68	72	75	78		81	
	bar	1,6	2,0	2,4	2,7	3,0	3,2	3,5	3,8	4,0	4,2	4,5	4,7	5,0	5,2	5,4		5,6	
	MAX. LOAD kg																		
<b>40 road</b>		3150	3595	4000	4295	4575	4750	5140	5535	5800	5955	6175	6310	<b>6500</b>					6,0
10HT light terrain		3770	4410	4920	5245	5600	5805	6150	6475	6650	6945	7380	7680	8120	8270	8410	8540		6,0
<b>10HT heavy terrain</b>		3150	3595	4000	4295	4575	4750	5140	5535	5800	5955	6175	6310	<b>6500</b>					6,0
10HT very heavy terrain		2495	2905	3285	3525	3760	3885	4100	4315	4430	4575	4770	4955	5235	5420	5615	5800		6,0
10LT light terrain		4635	5425	6035	6410	6825	7080	7500	7905	8120	8485	9025	9395	9940	10135	10315	10485		6,0
<b>10LT heavy terrain</b>		3875	4400	4875	5240	5585	5800	6285	6770	7100	7300	7580	7755	<b>8000</b>					6,0
10LT very heavy terrain		3070	3575	4035	4325	4595	4740	5000	5265	5405	5585	5820	6055	6405	6630	6870	7100		6,0

Speed Km/h	PRESSURE																* Infl. Pressure with tracks Bar		
	psi	23	29	35	39	43	46	51	55	58	61	65							
	bar	1,6	2,0	2,4	2,7	3,0	3,2	3,5	3,8	4,0	4,2	4,5							
	MAX. LOAD kg																		
<b>40 road</b>		3250	3710	4125	4425	4700	<b>4875</b>												5,0
10HT light terrain		3890	4550	5075	5410	5775	5980	6325	6655	6825									5,0
<b>10HT heavy terrain</b>		3250	3710	4125	4425	4700	4875												5,0
10HT very heavy terrain		3170	3690	4165	4455	4725	<b>4875</b>	5135	5415	5575	5765	6025							5,0
10LT light terrain		4785	5600	6215	6585	7000	7275	7725	8160	8400									5,0
<b>10LT heavy terrain</b>		4000	4530	5000	5390	5765	6000												5,0
10LT very heavy terrain		2575	2995	3390	3640	3875	4005	4225	4445	4555	4700	4895							5,0

Speed Km/h	PRESSURE																* Infl. Pressure with tracks Bar		
	psi	23	29	35	39	43	46	49	55	58	61	65							
	bar	1,6	2,0	2,4	2,7	3,0	3,2	3,4	3,8	4,0	4,2	4,5							
	MAX. LOAD kg																		
<b>40 road</b>		3650	4160	4625	4955	5260	<b>5450</b>												4,0
10HT light terrain		4365	5110	5700	6070	6475	6700	6980	7445	7630									4,0
<b>10HT heavy terrain</b>		3650	4160	4625	4955	5260	<b>5450</b>												4,0
10HT very heavy terrain		3565	4150	4680	5000	5305	5450	5655	6060	6230	6440	6725							4,0
10LT light terrain		5385	6300	6980	7385	7840	8145	8495	9115	9380									4,0
<b>10LT heavy terrain</b>		4500	5085	5600	6030	6440	<b>6700</b>												4,0
10LT very heavy terrain		2890	3365	3805	4085	5305	4490	4670	4975	5100	5260	5470							4,0



Driving tires for single axle fitment SIZE	LI/SI			New tire		Tire in service		SLR mm	RC mm	SRI	Rim	Tube
	ROAD	FOREST HT	FOREST LT	SW mm	OD mm	SW max mm	OD max mm					
<b>600/60-30.5</b> <b>T414 FS</b>	153A8	153A2	160A2	600	1495	638	1545		4485	700	AG20.00	600/60-30.5

Tires for all-round service SIZE	LI/SI			New tire		Tire in service		SLR mm	RC mm	SRI	Rim	Tube
	ROAD	FOREST HT	FOREST LT	SW mm	OD mm	SW max mm	OD max mm					
<b>500/45-22.5</b> <b>T404 FS</b>	129A8 Replace LI 12 PR	129A2	136A2	500	1020	525	1045		3066	485	AG16.00	500/45-22.5

Tires for all-round service SIZE	LI/SI			New tire		Tire in service		SLR mm	RC mm	SRI	Rim	Tube
	ROAD	FOREST HT	FOREST LT	SW mm	OD mm	SW max mm	OD max mm					
<b>500/60-22.5</b> <b>T421 SB</b>	144A8	144A2	151A2	500	1170	525	1200		3525	550	AG16.00	500/60-22.5

Speed Km/h	PRESSURE									
	psi	14	23	29	35	39	43	46	49	51
	bar	1,0	1,6	2,0	2,4	2,7	3,0	3,2	3,4	3,5
	MAX. LOAD kg									
<b>40 road</b>		1845	2900	3295	<b>3650</b>					
10HT light terrain		2290	3470	4060	4515	4800	5110			
<b>10HT heavy terrain</b>		1845	2900	3295	<b>3650</b>					
10HT very heavy terrain		1545	2295	2675	3020	3235	3440	3550	3685	
10LT light terrain		2800	4245	4970	5540	5905	6300			
<b>10LT heavy terrain</b>		2260	3550	4045	<b>4500</b>					
10LT very heavy terrain		1890	2810	3275	3700	3970	4230	4370	4545	

Speed Km/h	PRESSURE										* Infl. Pressure with tracks Bar
	psi	23	29	35	39	43	46	49	51		
	bar	1,6	2,0	2,4	2,7	3,0	3,2	3,4	3,5		
	MAX. LOAD kg										
<b>40 road</b>		1450	1660	<b>1850</b>							5,0
10HT light terrain		1735	2030	2270	2425	2590					5,0
<b>10HT heavy terrain</b>		1450	1660	<b>1850</b>							5,0
10HT very heavy terrain		1150	1335	1515	1625	1735	1795	1870			5,0
10LT light terrain		2155	2520	2790	2955	3155					5,0
<b>10LT heavy terrain</b>		1800	2035	<b>2240</b>							5,0
10LT very heavy terrain		1425	1660	1870	2000	2120	2180	2260			5,0

Speed Km/h	PRESSURE													* Infl. Pressure with tracks Bar
	psi	23	29	35	39	43	46	51	55	58	61	65	68	
	bar	1,6	2,0	2,4	2,7	3,0	3,2	3,5	3,8	4,0	4,2	4,5	4,7	
	MAX. LOAD kg													
<b>40 road</b>		1900	2175	2430	2585	2720	<b>2800</b>							5,0
10HT light terrain		2275	2660	2975	3180	3405	3505	3680	3850	3920				5,0
<b>10HT heavy terrain</b>		1900	2175	2430	2585	2720	<b>2800</b>							5,0
10HT very heavy terrain		1505	1750	1985	2135	2275	2355	2485	2595	2645	2720	2810		5,0
10LT light terrain		2750	3220	3630	3910	4200	4320	4540	4745	4830				5,0
<b>10LT heavy terrain</b>		2300	2660	3000	3185	3350	<b>3450</b>							5,0
10LT very heavy terrain		1820	2120	2405	2600	2790	2900	3065	3200	3260	3350	3465		5,0

For technical notes about pressure tables please refer to page 260.

## Twin Forestry - T404 - T414 - T421 SB - T428 SB - T440 - T480

X-ply tires for forestry equipment



# T418 FORESTRY SKIDDER

Trelleborg T418 is the perfect tire for heavy-duty logging service. It is specifically designed for log skidding service with maximum penetration and tear resistance to provide longer tire life under the most severe operating conditions. The armored plies and steel belt protect the carcass against stumps, boulders and rocks.



**T418**

**T418 High Power**

SIZE	PR	New tire		Tire in service		SLR mm	RC mm	Rim	Type	Tube
		SW mm	OD mm	SW max mm	OD max mm					
23.1-26 T418	16	600	1615	615	1655	750	4810	DW20B	TL	23.1-26 TR218

SIZE	PR	New tire		Tire in service		SLR mm	RC mm	Rim	Type	Tube
		SW mm	OD mm	SW max mm	OD max mm					
28L-26 T418	20	705	1630	725	1670	747	4855	DW25B	TL	28L-26 TR218

SIZE	PR	New tire		Tire in service		SLR mm	RC mm	Rim	Type	Tube
		SW mm	OD mm	SW max mm	OD max mm					
28L-26 T418	26	705	1630	725	1670	747	4855	DW25B	TL	28L-26 TR218

SIZE	PR	New tire		Tire in service		SLR mm	RC mm	Rim	Type	Tube
		SW mm	OD mm	SW max mm	OD max mm					
24.5-32 T418	16	630	1825	645	1870	832	5425	DH21	TL	24.5-32 TR218



## SIZE

**23.1-26 16 PR**

**28L-26 20 PR**

**28L-26 26 PR**

**24.5-32 16 PR**

**30.5L-32 20 PR**

## SIZE

**30.5L-32 26 PR**

**30.5L-32 32 PR**

**DH 35.5L-32 24 PR**

**DH 35.5L-32 30 PR**

All product are steel belted

Speed Km/h	PRESSURE														
	psi	12	14	17	20	23	26	29	32	35	38	41	43	46	48
	bar	0,8	1,0	1,2	1,4	1,6	1,8	2,0	2,2	2,4	2,6	2,8	3,0	3,2	3,3
	<b>MAX. LOAD kg</b>														
40 road		1890	2150	2395	2620	2830	3035	3230	3410	3590					
<b>30 road</b>		2360	2690	2995	3275	3540	3795	4035	4265	<b>4490</b>					
10 light terrain		2900	3305	3680	4020	4345	4660	4955	5235	5515	5780	6035	6280		
10 heavy terrain		2360	2690	2995	3275	3540	3795	4035	4265	4490					
10 very heavy terrain		1935	2205	2455	2685	2905	3110	3310	3495	3680	3860	4030	4195	4360	4435

Speed Km/h	PRESSURE																
	psi	12	14	17	20	23	26	29	30	32	35	38	41	42	43	46	48
	bar	0,8	1,0	1,2	1,4	1,6	1,8	2,0	2,1	2,2	2,4	2,6	2,8	2,9	3,0	3,2	3,3
	<b>MAX. LOAD kg</b>																
40 road		2170	2470	2750	3010	3250	3485	3705	3810	3915	4120						
<b>30 road</b>		2710	3085	3435	3760	4065	4355	4630	4765	4895	<b>5150</b>						
10 light terrain		3330	3790	4220	4615	4990	5350	5385	5850	6010	6325	6625	6920	7065	7210		
10 heavy terrain		2710	3085	3435	3760	4065	4355	4630	4765	4895	5150						
10 very heavy terrain		2220	2530	2815	3085	3335	3570	3795	3905	4015	4225	4425	4620	4720	4815	5000	5090

Speed Km/h	PRESSURE											
	psi	12	17	23	29	35	41	43	49	55	60	67
	bar	0,8	1,2	1,6	2,0	2,4	2,8	3,0	3,4	3,8	4,2	4,7
	<b>MAX. LOAD kg</b>											
40 road		2230	2830	3345	3810	4240	4640	4830	5200			
<b>30 road</b>		2790	3535	4180	4765	5300	5800	6040	<b>6500</b>			
10 light terrain		3425	4340	5135	5850	6510	7120	7415	7980	8515	9030	
10 heavy terrain		2790	3535	4180	4765	5300	5800	6040	6500			
10 very heavy terrain		2290	2900	3430	3905	4345	4755	4955	5330	5685	6030	6440

Speed Km/h	PRESSURE													
	psi	12	14	17	20	23	26	29	30	32	35	38	41	42
	bar	0,8	1,0	1,2	1,4	1,6	1,8	2,0	2,1	2,2	2,4	2,6	2,8	2,9
	<b>MAX. LOAD kg</b>													
40 road		2275	2590	2885	3155	3410	3655	3890	4000					
<b>30 road</b>		2845	3240	3605	3945	4265	4570	4860	<b>5000</b>					
10 light terrain		3495	3980	4425	4845	5235	5610	5970	6140	6310	6635	6955		
10 heavy terrain		2845	3240	3605	3945	4265	4570	4860	5000					
10 very heavy terrain		2335	2655	2955	3235	3495	3745	3985	4100	4215	4430	4645	4850	4955

## T418 FORESTRY SKIDDER

X-ply tire for forestry equipment



SIZE	PR	New tire		Tire in service		SLR mm	RC mm	Rim	Type	Tube
		SW mm	OD mm	SW max mm	OD max mm					
<b>30.5L-32</b> <b>T418</b>	20	760	1840	780	1885	840	5470	DH27	TL	30.5-32 TR218

SIZE	PR	New tire		Tire in service		SLR mm	RC mm	Rim	Type	Tube
		SW mm	OD mm	SW max mm	OD max mm					
<b>30.5L-32</b> <b>T418</b>	26	760	1840	780	1885	840	5470	DH27	TL	30.5-32 TR218

SIZE	PR	New tire		Tire in service		SLR mm	RC mm	Rim	Type	Tube
		SW mm	OD mm	SW max mm	OD max mm					
<b>30.5L-32</b> <b>T418 High Power</b>	32	770	1880	790	1905	865	5590	DH27	TL	30.5-32 TR218

SIZE	PR	New tire		Tire in service		SLR mm	RC mm	Rim	Type	Tube
		SW mm	OD mm	SW max mm	OD max mm					
<b>DH35.5L-32</b> <b>T418</b>	24	890	2000	920	2040	905	5925	DH31	TL	

SIZE	PR	New tire		Tire in service		SLR mm	RC mm	Rim	Type	Tube
		SW mm	OD mm	SW max mm	OD max mm					
<b>DH35.5L-32</b> <b>T418 High Power</b>	30	920	2035	950	2075	920	6030	DH31	TL	

Speed Km/h	PRESSURE													
	psi	12	14	17	20	23	25	26	29	30	35	38	42	
	bar	0,8	1,0	1,2	1,4	1,6	1,7	1,8	2,0	2,1	2,4	2,6	2,9	
	MAX. LOAD kg													
40 road		2730	3110	3460	3790	4095	4240	4390	4665	4800				
<b>30 road</b>		3410	3885	4325	4735	5120	5300	5485	5830	<b>6000</b>				
10 light terrain		4185	4770	5310	5815	6285	6510	6735	7160	7370	7965	8350		
10 heavy terrain		3410	3885	4325	4735	5120	5300	5485	5830	6000				
10 very heavy terrain		2795	3185	3545	3885	4200	4345	4500	4780	4920	5320	5575	5940	

Speed Km/h	PRESSURE																		
	psi	12	14	17	20	23	26	29	32	35	38	41	43	46	49	52	55	57	
	bar	0,8	1,0	1,2	1,4	1,6	1,8	2,0	2,2	2,4	2,6	2,8	3,0	3,2	3,4	3,6	3,8	3,9	
	MAX. LOAD kg																		
40 road		2730	3110	3460	3790	4095	4390	4665	4930	5190	5440	5680							
<b>30 road</b>		3410	3890	4325	4735	5120	5485	5830	6165	6490	6800	<b>7100</b>							
10 light terrain		4185	4775	5310	5815	6285	6735	7160	7570	7970	8350	8720	9075	9425	9770				
10 heavy terrain		3410	3890	4325	4735	5120	5485	5830	6165	6490	6800	7100							
10 very heavy terrain		2795	3190	3545	3885	4200	4500	4780	5055	5320	5575	5820	6060	6295	6525	6745	6960	7070	

Speed Km/h	PRESSURE												
	psi	12	17	23	29	35	41	46	48	54	61	65	68
	bar	0,8	1,2	1,6	2,0	2,4	2,8	3,2	3,4	3,8	4,2	4,5	4,7
	MAX. LOAD kg												
40 road		2745	3480	4115	4690	5220	5710	6175	6400				
<b>30 road</b>		3430	4350	5145	5865	6525	7140	7720	<b>8000</b>				
10 light terrain		2815	3565	4220	4810	5350	5855	6330	6560	7005	7425	7730	7930
10 heavy terrain		4210	5340	6320	7200	8015	8770	9480	9825	10510	1200		
10 very heavy terrain		3430	4350	5145	5865	6525	7140	7720	8000				

Speed Km/h	PRESSURE												
	psi	12	14	17	20	23	26	30	32	35	38	41	42
	bar	0,8	1,0	1,2	1,4	1,6	1,8	2,1	2,2	2,4	2,6	2,8	2,9
	MAX. LOAD kg												
40 road		3640	4150	4610	5050	5460	5850	6400					
<b>30 road</b>		4550	5185	5765	6310	6825	7310	<b>8000</b>					
10 light terrain		5890	6715	7465	8170	8840	9465	10360	10645	11200			
10 heavy terrain		4550	5185	5765	6310	6825	7310	8000					
10 very heavy terrain		3730	4250	4725	5175	5595	5995	6560	6740	7095	7435	7760	7925

Speed Km/h	PRESSURE																	
	psi	12	15	17	20	23	26	29	32	35	38	41	44	46	49	52	55	57
	bar	0,8	1,0	1,2	1,4	1,6	1,8	2,0	2,2	2,4	2,6	2,8	3,0	3,2	3,4	3,6	3,8	3,9
	MAX. LOAD kg																	
40 road		3640	4150	4610	5050	5460	5850	6245	6600	6945	7275	7600						
<b>30 road</b>		4550	5185	5765	6310	6825	7310	7805	8250	8680	9095	<b>9500</b>						
10 light terrain		5890	6715	7465	8170	8840	9465	10105	10645	11200	11780	12305	12810	13300				
10 heavy terrain		4550	5185	5765	6310	6825	7310	7805	8250	8680	9095	9500						
10 very heavy terrain		3730	4250	4725	5175	5595	5995	6400	6740	7095	7435	7760	8110	8420	8730	9025	9315	9455

For technical notes about pressure tables please refer to page 260.

## T418 FORESTRY SKIDDER

X-ply tire for forestry equipment



# Common technical notes for radial tires

**IF (Improved Flexion)** = up to 20% more load at the same pressure versus standard technology.

**VF (Very High Flexion)** = up to 40% more load at the same pressure versus standard technology.

**CF0 (Cyclic Field Operation)** = up to 20% more load at the same pressure versus standard technology and a further load increase in cyclic field application, without any increase in inflation pressure.

**SW** = Section Width (see p. 262) measured on the nominal rim (not referred to permitted rims).

**SRI** = Speed Radius Index (see p. 262) - value to be used for the calculation of the theoretical tractor speed during European Union homologation and for the interchangeability of different tire sizes.

**70/65/50/40/30/25** = on road transport at 70/65/50/40/30/25 Km/h.

**10 LT** = maximum speed 10 Km/h. Surface treatment with low torque value.

**10 HT** = maximum speed 10 Km/h. Field application with high torque value.

**TL** = tubeless.

**TT** = tubetype.

**S** = single fitment.

**H** = maximum speed 10 Km/h. Harvesting machines in cyclic loading service and farm to field transit.

Nominal speed and load are shown in the tables in **bold**.

For **intensive road transport** above 40 Km/h, increase the pressure by 0,4 bar.

All load values are valid for **ground slopes** up to 20%. Above 20% increase the pressure by 0,4 bar (TM3000 and HF1000 by 0,5).

**IMPORTANT: the inflation pressure is established considering the application and the load for each tire.**

**For dual mounting use the pressure correspondent to the load per each wheel divided by 0.88.**

# Specific technical notes for radial tires

<b>TM1000 PT</b>	(*) = 10 LT at 0,4 bar only dual/triple use. (**) = 10 HT at 0,6 bar only dual/triple use.
<b>TM1000 HP</b>	(*) Below 0,8 bar only for dual/triple use in LT application. For intensive road transport above 40 Km/h the pressure have to be increased by 0,4 bar. All load value for ground slopes up to 20% (above 20% consult Trelleborg).
<b>TM1060</b>	(*) = 10 HT at 0,6 bar only in dual/triple use.
<b>TM800</b>	(°) = for these rims please contact the Trelleborg expert in your area.
<b>TM800 HS</b>	(°) = for these rims please contact the Trelleborg expert in your area.
<b>TM700 PT</b>	(°) = for these rims please contact the Trelleborg expert in your area.
<b>TM100</b>	<b>10 Cyc</b> = maximum speed 10 Km/h. Field application with 20% slope max. <b>TO BE MOUNTED IN TUBELESS VERSION ONLY FOR TRACTORS GREATER THAN 190 HP</b>
<b>TM3000</b>	(*) = single mounting. <b>Up to 40 km/h</b> = only for road application. <b>15 Cyc</b> = cyclic application on field up to 15 Km/h. For special applications (different from classic cyclic harvesting such as cereals and/or classic oilseed plants) please contact the Trelleborg expert in your area.
<b>TM2000</b>	<b>10 LT</b> = maximum speed 10 Km/h. Surface treatment with low torque value. Harvesting machines in cyclic loading service and field to farm transit. Max slope up to 40%. <b>10 HT</b> = maximum speed 10 Km/h. Field application with high torque value. <b>10 Cyc</b> = maximum speed 10 Km/h. Harvesting machines in cyclic loading service and field to farm transit.
<b>HF1000</b>	<b>65/50/40</b> = on road transport at 65/50/40 Km/h. <b>30</b> = on road transport at 30 Km/h and field application up to 30 Km/h. <b>10</b> = on field application up to 10 Km/h with self-propelled machines (eg. harvesting machine).

<b>TWIN RADIAL</b>	<b>65/50/40</b> = on road transport at 65/50/40 Km/h. <b>30</b> = on road transport at 30 Km/h and field application up to 30 Km/h. <b>10</b> = on field application up to 10 Km/h with self-propelled machines (eg. harvesting machine).
<b>TH400-TH500</b>	<b>50/40/35/30/25</b> = use on the road up to a max speed of 50/40/35/30/25 Km/h. <b>10 Cyc</b> = max speed 10 Km/h with cyclic load. <b>Stat</b> = static load at 0 Km/h. For Torque application refer to 30 Km/h.
<b>MPT100</b>	After 2 hours of driving on highways ½ hour stop for cooling down of the tyres. Load values for 0,6 bar are for calculating dual and triple load values only. For low-speed high-torque field work apply 30 km/h load values. wFor intensive road transport above 30 Km/h, increase the pressure by 0,4 bar.

## Common technical notes for X-ply (conventional) tires

**SW** = Section Width (see p. 262) measured on the nominal rim (not referred to permitted rims).

**SRI** = Speed Radius Index (see p. 262) - value to be used for the calculation of the theoretical tractor speed during European Union homologation and for the interchangeability of different tire sizes.

**F** = refers to tractors with mounted implements operating in the field.

**IMPORTANT: the inflation pressure is established considering the application and the load for each tire.**

Load data in the table is valid for one wheel only.

Nominal speed and load are shown in the table in **bold**.

**TL** = tubeless.

**TT** = tubetype.

For intensive road transport above 40 Km/h, increase the pressure by 0,4 bar.

All load values are valid for **ground slopes** up to 20%. Above 20% increase the pressure by 0,4 bar.

## Specific technical notes for conventional tires

**T414** **TL** = tubeless, but tube can be used. All tubes have valve type TR218 if not other is specified.

### Tires for agricultural tractors and machines

**25/30/40/50** = 25/30/40/50 Km/h road service.

(Note: for frequent or long distance road transport, increase the inflation pressure by 30%).

**10 HT** = 10 Km/h field service with high torque.

(Note: in extra heavy and continuous field service such as ploughing, increase inflation pressures by 30%).

**10 LT** = 10 Km/h field service with low torque.

**10 C** = 10 Km/h cyclic field service for combine harvesters with a gradually increasing load (filling or grain tank) up to max. load and unloading before transportation on field or road. Min. load may not exceed 60% of max. load. The ground must not have slopes > 20% (> 11 degree).

**TM90**      **40/30/25** = on road transport at 40/30/25 Km/h.  
**10 LT** = maximum speed 10 Km/h. Surface treatment with low torque value.  
Harvesting machines in cyclic loading service and field to farm transit. Slope up to 40%.  
**10 HT** = maximum speed 10 Km/h. Field application with high torque value.  
**S** = single fitment.  
**H** = maximum speed 10 Km/h. Harvesting machines in cyclic loading service and farm to field transit.  
**For dual mounting use the pressure correspondent to the load per each wheel divided by 0.88.**

**TD27**      **SW** = section width value measured with the rim in bold.

**T404 - T421**  
**T423 - T478**      **Twin Implement LI/SS**  
**TL** = tubeless, but tube can be used. All tubes have valve type TR218 if no other is specified.  
All load data refer to LLV = Low Load Variation (<50%). HLV=High Load Variation (>50%).  
**For dual mounting use the pressure correspondent to the load per each wheel divided by 0.88.**  
**Tires for trailers, implements and agricultural machines**  
**50 - 40** = 50 and 40 Km/h road service, either free rolling or driving.  
**10** = 10 Km/h field service in either free rolling or driving (load capacities of driving wheel are 30% < free rolling wheel).  
**25** = 25 Km/h road service in driving mode (combine harvesters).  
**10 C** = 10 Km/h cyclic field service for combine harvesters with a gradually increasing load (filling or grain tank) up to max. load. Min. load may not exceed 50% of max. load.  
The ground must not have slopes > 20% (> 1.1 degree).  
In HLV service the LLV load data can be increased by 20 % if the inflation pressure is increased by 30%.  
HLV is suitable only for shorter transport service. LLV = low load variation (<50%).  
HLV = high load variation (>50%).  
In longer road transport with heavy vehicles or vehicles with a high gravity point, use LLV data with an increase in the inflation pressure of 30%.  
Implement tires in the steering wheel position on self propelled vehicles must use the load data for driving tires.

**T421 - T423**  
**T428 - T440**      **Tires for agricultural machines/vehicles with a high rate of road service or at high speeds**  
**TL** = tubeless. Tubes are not suitable for use in AMPT tires.  
**0** = 0 Km/h concerns accidental loads (e.g. When a machine is breaking/lifting with its bucket).  
**10** = 10 Km/h concerns field service.  
**40 - 65 - 70** = 40, 65 and 70 Km/h concerns road service.  
**Note:** always check that the rims/wheels are suitable for the service. If loads are to exceed 10000 kg, please contact the Trelleborg expert in your area.

**T404**      **Tires for gentle service on green areas**  
**TL** = tubeless. Tubes are not suitable for use in garden tractor tires.  
**25** = 25 Km/h concerns service on green areas and road.  
**40** = 40 Km/h concerns service on road only.

**AW305 - AF302**  
**T452 - T306**  
**AW309**      **Implement Standard**  
Tires for trailers, implements and agricultural machines.  
**Speed 50 to 40** = 50 to 40 Km/h road service, either free rolling or driving.  
**Speed 10** = 10 Km/h field service, either free rolling or driving.  
All load data refer to LLV service.  
**LLV** = low load variation (>50%).  
**HLV** = high load variation (50%).  
In HLV service the LLV load data can be increased by 20% if the inflation pressure is increased by 30%.  
HLV in road speeds are suitable for shorter transport service only.  
**In longer road transports with heavy vehicles or vehicles with a high gravity point, use LLV data and increase the inflation pressure with 30%.**  
Free rolling tires on tractor steering wheels - use LLV free rolling data minus 20%.  
**TL** = tubeless, but tube can be used.

**T410**  
**Agroforest**      **Tractor tires for Agroforest use**  
**TT** = tube type. All tubes have valve type TR218 if no other is specified.  
**10-30-40-50** = 10-30-40-50 Km/h road service.  
**10HT** = 10 Km/h service in terrain with or without stones/rocks.

**T440 - T480**  
**T428 - T421**  
**T414 - T404**

**Twin Forestry LI/SS version**

Load data in the table is valid for one wheel only.  
All tires are tube type. All tubes have valve type TR218.  
SB = steel belt reinforced.  
LS = log service, 2 = Tread code.  
HT = high torque, also refers to skidder service.  
LT = low torque and refers to service on forwarders and harvesters.

**Tires for forestry use, LI version**

40 road = 40 Km/h road service.  
10HT, LT = high torque, also refers to skidder service in light terrain = 10 Km/h service in flat terrain without boulders/stones.  
10HT, HT = high torque, also refers to skidder service in heavy terrain = 10 Km/h service in rough terrain with or without boulders/stones.  
10HT, HT = high torque, also refers to skidder service in very heavy terrain = 10 Km/h service in very rough terrain with very high proportion of boulders/stones.  
10LT, LT = low torque and refers to service on forwarders and harvesters in Light terrain = 10 Km/h service in flat terrain without boulders/stones.  
10LT, HT = low torque and refers to service on forwarders and harvesters in Heavy terrain = 10 Km/h service in rough terrain with or without boulders/stones.  
10LT, HT = low torque and refers to service on forwarders and harvesters in very heavy terrain = 10 Km/h service in rough terrain with very high proportion of boulders/stones.

**Twin Forestry PR version**

Most of the tires are tube type. All tubes have valve TR218.  
Some tires are marked tubeless but it is recommended to use tube.

**SB** = steel belt reinforced.

**Tire for all-round service** = can be used on all type of machine and in tandem position with track.

**Tire for single axle fitment** = can only be used on single axles.

By use of tracks, the air pressure shall be increased to max. level for what is started by very heavy terrain.

**Tires for forestry use, PR version**

40 - 30 road = 40 and 30 Km/h road service.  
10HT or 10LT Light terrain = 10 Km/h service in flat terrain without occurrence of stone blocks.  
10HT or 10LT Heavy terrain = 10 Km/h in rough terrain with or without stone blocks.  
10HT or 10LT very Heavy terrain = 10 Km/h in very rough terrain with very large occurrence of stone blocks.  
\* When using track the inflation pressure according to the table must be used independent of the wheel load. Twin 428 only.

For general information about inflations pressure, fitting and handling of forestry tires please see page. 284 - 285.

**T418**  
**FORESTRY**  
**SKIDDER**

**Tires for forestry use**

Load data in the table is valid for one wheel only.  
40 - 30 road = 40 and 30 Km/h road service.  
10HT or 10LT Light terrain = 10 Km/h service in flat terrain without occurrence of stone blocks.  
10HT or 10LT Heavy terrain = 10 Km/h in rough terrain with or without stone blocks.  
10HT or 10LT very Heavy terrain = 10 Km/h in very rough terrain with very large occurrence of stone blocks.

**T440 EXC**  
**T480 EXC - T459**

TL = tubeless, but tube can be used.  
All tubes have valve type TR218 if not other is specified.

**Tires for industrial tractors**

40-50 = 40-50 Km/h road service.  
10 = 10 Km/h road and field service.  
0 = 0 Km/h accidental loads (eg. when a machine is breaking/lifting with its buckets).  
**Important:** for loads exceeding 10.000 kg, please contact the Trelleborg expert in your area.





**Light service**  
**tires**

Max load and pressure in the table above are for free rolling service LLV at speed 10, 20 25, 30, 40 and 100 Km/h.  
LLV = low load variation, e.g. implements (ploughs, cultivator, etc.) and trailers with minor variations in load.  
For LLV in driving service decrease the load with 30%.  
HLV = high load variation e.g. trailers, e.g. trailers with significant variations in load.  
For HLV the maximum load can be increased by 20% if the inflation pressure increases with 30%.  
RC = rolling circumference = calculated values.



# Tire marking

A series of numbers and codes internationally used exist for the identification of tire structures, dimensions and main applications. This group of codes and numbers is collectively known as the “markings” and permits precise identification of the tire.

Here below some examples:

<b>1</b>	TRELLEBORG	Brand name and / or manufactures name
<b>2</b>	TM800 or TWIN 421	Product name (tread pattern identification)
<b>3</b>	SIZE DESCRIPTION	Metric tire size designation
<b>a</b>	600/65R38 600/60-30.5 520/70B30	600 = section width (mm) 65 = aspect ratio between section height and section width (%) R = radial construction 38 = rim diameter (inch) - = cross ply construction B = bias belted construction
<b>b</b>	650/60-26.5 LS2	Metric tire size designation for forestry tires LS = log service 2 = tread depth code
<b>c</b>	7.50-16	Coded tire size designation 7.50 = section width (inch) - = cross ply construction 16 = rim diameter (inch)
<b>d</b>	20.5x10.0-10	American tire size designation 20.5 = overall diameter (inch) x = versus 10.0 = section width (inch) - = cross-ply construction 10 = rim diameter (inch)
<b>4 a</b>	157 A8 	Service description 157 = load index for the tires nominal load capacity A8 = speed symbol for the tires nominal speed 154 = additional load index at max speed B = additional speed symbol for max speed
<b>b</b>	8 PR	Tire carcass strength identification 8 = strength index PR = ply rating (but does not necessarily represent the number of cord plies in the tire)
<b>c</b>	166 A8  154 A8 	Service description (implement) Load index and speed symbols as 4.a   → free rolling tire  → driving tire



<b>d</b>	161A8 HT 161 A2 LT 168 A2	Service description (forestry) Load index and speed symbols as 4.a 161 A8 = service on road HT 161 A2 = high torque service (skidders) LT 168 A2 = low torque service (forwarders, harvesters)
<b>e</b>	99J	Service description (high speed trailer) Load index and speed symbols as 4.a
<b>5</b>	IMP or other	Service type identification IMP = implement Other service identifications are: FORESTRY = tires for forestry machines AGROFOREST = tires for mixed agri and forestry service AMPT = Agricultural Multi Purpose Tire : tires for a high rate of road service up to 65 Km/h LOADER = tires for wheel loaders and back hoe loaders GARDEN TRACTOR = tires for gentle service on green surfaces INDUSTRIAL = tires for Industrial service FRT = free rolling tire: commercial vehicle tire used as high speed implement trailer tire
<b>6</b>	STEEL BELT	The tire has a belt of steel cord (forestry tires)
<b>7</b>	TUBELESS	Tire to be used without a tube (some tubeless tires are marked that they are allowed to be used with a tube)
<b>8</b>		Arrow indicating rotating direction of a traction tire in driving service
<b>9</b>		Pictogram showing the max seating pressure (varies for different type of tires)
<b>10</b>	SAFETY WARNING	Warning text which states the items to be paid attention to when fitting the tire
<b>11</b>	 106R-00 0001	ECE type approval mark and number (often called “e-marking”)

### Technical advice

For more detailed information, consult our complete Manual containing all technical information on our web page [www.trelleborgtirebook.com](http://www.trelleborgtirebook.com), or download the Tire Book app from App Store or Google Play.

**Remark:** Other numbers (small figures) can be found on the tyre sidewall.  
For any question please contact the Trelleborg expert in your area.

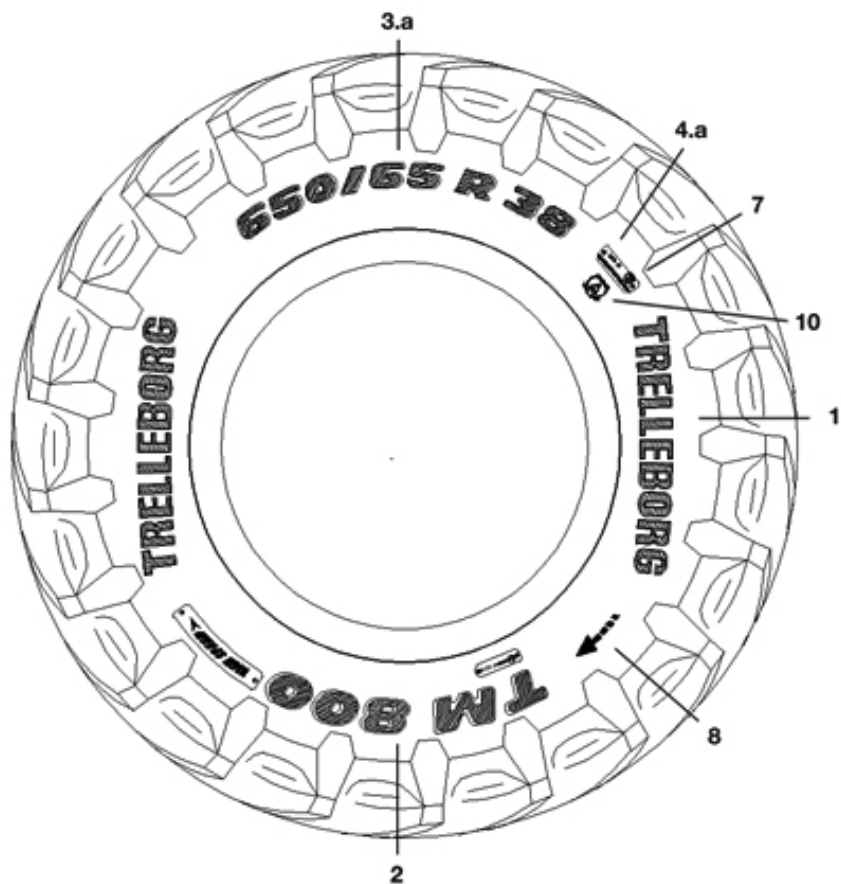

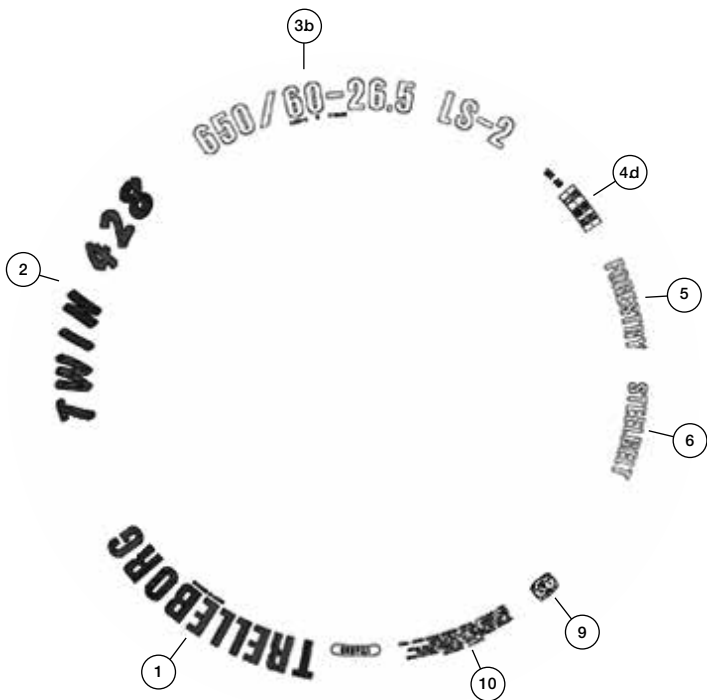
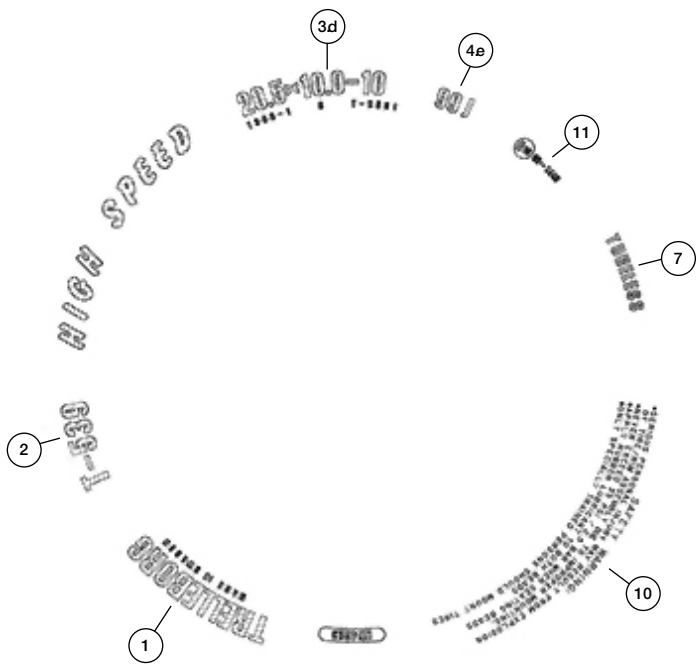

# Technical data symbols

The following symbols are used in the technical data charts

## Dimensions

### Size

States tire size designation.

### LI - SS

States tire Load Index and Speed Symbol.

LI is a code for the tire load capacity at its nominal maximum speed.

SS is a code indicating the tire nominal maximum speed.

### PR

States tire ply rating and is a strength code for the tire carcass.

### Type or Tread pattern

States the tire tread symbol or pattern. If it is a tubeless tire, the tire is marked with the symbol TL after the tread symbol.

### New tire

States tire diameter and width in mm, when the tire is originally mounted with a nominal inflation pressure.

### SW

The Section Width of the unloaded tire. If the tire is fitted on a rim which is narrower (or wider) than that underlined, the section width is obtained by decreasing (or increasing) the value shown by 40% of the rim width variation (in millimetres).

### OD

The Overall Diameter of the unloaded tire.

### RC

Rolling Circumference at reference load and pressure. Distance covered in one complete revolution of the wheel on an asphalt road. Value in mm measured according to ISO11795.

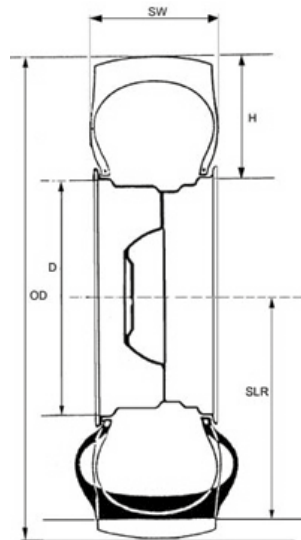

### SLR

Static Loaded Radius is the radius from the wheel centre down to the ground, at reference load and pressure. The difference between unloaded radius and static loaded radius is called deflection. This value varies between 15-30% of the tire section height, depending on tire type.

### SRI

The Speed Radius Index states a theoretical value only to be used for calculation of the max speed of a vehicle according to EU homologation procedures.

### Tire in service

States the tire max. diameter and width in mm that the tire may reach during its lifetime. These are the measurements manufacturers should pay attention to when designing new vehicles and machinery, to obtain adequate clearance for the wheel.

## Rim

States recommended rim size. Rim width is expressed in inches e.g. **16.00**. A letter symbol in connection with rim width represents the code for the rim contour. The rim diameter is expressed in inches.

Rim diameters ending with 0.5 (17.5, 22.5 etc.) are 15-degree rims. Remaining rims are 5-degree (34, 38, 42 etc.). In the table only the rim width is stated.

**Please check the list of rims included.**

## Tube

States the tube to be used for each size.

Example of tube marking:

STT brand	Size designation	valve
	<b>7.50 – 16 (*)</b>	<b>TR15</b>
	<b>520/70-30 / 18.4-30 (**)</b>	<b>TR218</b>
TWIN brand	Size designation	valve
	<b>600/55-30.5 / 600/60-30.5 (**)</b>	<b>TR218</b>

(\*) The tube is marked in the same way as the corresponding type. No marking on the tube concerning valve type.

(\*\*) Double size marking means that the tube fits the corresponding tire sizes.

No marking on the tube concerning valve type.

## Speed



The speed indicated in the table represents the maximum speed in use for the tire at the given load and pressure. Speed notation

in bold types states the nominal speed for the tire.

**Speed 1 Km/h = 0,62 mph**

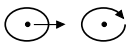
## Free rolling and driving wheel



These are new symbols used for Implement tires and states free rolling  and driving service . Loadwise, the load capacity is 30% less for driving wheels than for free rolling wheels.

## Inflation pressure

The inflation pressures refer to tires at ambient temperature. The values given in the tables represent the “**reference pressure**” for the load and speed conditions shown. The actual pressure of the tire must be established in accordance with the mechanical characteristics of the vehicle, the additional load from the use of equipment and additional storage facilities, as well as the load conditions.

These values can be obtained from the “**load / pressure / application**” tables according to the use:

### **Tractor tires**

- on road at various speeds
- on field at “high torque” (ploughing, harrowing, etc.)
- on field at “low torque”(surface works, sowing, etc.)
- cyclic loading service on harvesting machines

### **Implement tires**

- free rolling wheel - road service
- free rolling wheel - field service
- driving wheel - road service
- driving wheel - field service

### **Forestry tires**

- on road
- on light terrain
- on heavy terrain and road service
- on very heavy terrain

### **Green area and garden tires**

- on road
- on field

### **AMPT tires or loaders and excavator tires**

- road service
- field service

For tires with A8 or D marking, in frequent or long distance road transport at speeds of more than 30 Km/h, the inflation pressure should be increased by 0.4 bar over the nominal value obtained for effective loads on the axles.

Inflation pressure **1 bar = 100 kPa**  
**1 bar = 14,5 psi**

## **Load capacity**

The load capacity is the maximum load (expressed in kg) a tire is permitted to carry under specified operating conditions. The nominal load is stated in bold type.

# Tire size correspondance

ETRTO SRI	Rim diameter	Standard series	Standard series /80-/85	Wide series /70-/75	Extra large series /60-/65-/85	Narrow series /90-/95- /105	TWIN TRACTOR		
							/45-/50	/55	/60-/55
350	16			240/70R16					
360	16	6.50-16 9.0/75-16							
370	16			260/70R16					
380	16	7.50-16	250/80-16	280/70R16		210/95R16			
410	18	7.50-18	250/80-18	280/70R18	320/65R18	210/95R18			
425	17.5							400/55-17.5	
	18				340/65R18				
450	20	7.50R20							
	20	9.5R20	260/80R20	280/70R20 300/70R20					
475	18		340/80R18	400/70R18					
	20	11.2R20	280/85R20	320/70R20					
500	24	8.3/R24							
	20	12.4R20	320/85R20	360/70R20					
525	24	9.5/R24							360/60-24
	20			400/70R20 380/70R20					
550	20		280/85R24	320/70R24					
	24	11.2R24							
550	22.5				500/60R22.5		600/50-22.5		
	24	12.4R24	320/85R24	360/70R24	420/65R24				
575	26.5								400/60-26.5
	24	13.6R24	340/85R24	380/70R24 400/70R24	440/65R24				
600	24	11.2R28	280/85R28	320/70R28					
	28								
600	22.5				560/60R22.5				
	24	14.9R24	380/85R24	460/70R24 420/70R24	480/65R24				500/60-26.5
625	26.5	12.4R28	320/85R28	360/70R28		230/95R32			
	32								
625	22.5				580/65R22.5				
	24	16.9R24	420/85R24	480/70R24 500/70R24	540/65R24				
650	24		440/80R24						
	26.5						710/45-26.5	600/55-26.5	600/55-26.5
650	28	13.6R28	340/85R28	380/70R28	440/65R28				
	26	16.9R26		480/70R26	540/65R26				
675	28	14.9R28	380/85R28	420/70R28	480/65R28				
	28				520/60R28				
700	32					270/95R32			
	36					230/95R36			
675	26		480/80R26	480/70R28	750/50R26				
	28	16.9R28	420/85R28		540/65R28				
700	28		440/80R28						
	28				600/60R28				
700	30	14.9R30	380/85R30	420/70R30					
	26.5								
700	28				600/65R28				
	30	16.9R30	420/85R30	480/70R30	540/65R30 600/60R30				
700	30								
	30.5						710/50-30.5		
700	30.5						750/45-30.5	600/55-30.5	
	36	12.4/R36							



ETRTO SRI	Rim diameter	Standard series	Standard series /80-/85	Wide series /70-/75	Extra large series /60-/65-/85	Narrow series /90-/95- /105	TWIN TRACTOR		
							/45-/50	/55	/60-/55
725	26	18.4R30	460/85R30	520/70R30	620/70R26 600/70R28	420/90R30	780/50-28.5 750/50-30.5		600/60-30.5
	28								
	28.5								
	30								
	30.5								
	34								
750	34	16.9R34 13.6R38	420/85R34 340/85R38	480/70R34 400/75R38	620/75R26 600/70R30 480/70R34 400/75R38	540/65R34		210/95R44 230/95R44	
	36								
	38								
	38								
	44								
	44								
775	25	18.4R34 14.9R38	460/85R34 380/85R38	520/70R34	1000/50R25 750/65R26 710/60R30 650/65R30.5 600/65R34 650/60R34		800/55-30.5 710/55-34		
	26								
	30								
	30.5								
	34								
	34								
800	30	16.9R38	420/85R38	620/75R30 600/70R34 480/70R38	620/75R30 750/60R30.5 600/60R38	540/65R38 600/60R38	800/50-34	380/95R38 270/95R44 230/95R48	600/60-38
	30.5								
	34								
	38								
	38								
	44								
825	34	18.4R38	460/85R38 480/80R38	520/70R38	650/65R34 710/60R34 600/65R38 650/60R38				650/60-38
	34								
	38								
	38								
	38								
	38								
875	32	20.8R38 18.4R42	520/85R38 480/80R42	580/70R38	650/75R32 710/75R32 1050/50R32 800/65R32 800/60R32 650/65R38 600/65R42	710/60R38	850/50-38	300/95R46 270/95R48	900/60-32
	32								
	32								
	38								
	42								
	46								
925	32	20.8R42	520/85R42 480/80R46	800/70R32 650/75R38 710/70R38 580/70R42 620/70R42	900/60R32 900/65R32 650/65R42 710/60R42			380/90R46 300/95R52	710/65-38 750/65-38
	32								
	38								
	38								
	42								
	42								
975	38	20.8R46	520/85R46 480/80R50	800/70R38 650/75R42 710/70R42	650/85R38 900/60R38		850/55-42	380/105R46 380/90R50	850/60-38
	38								
	38								
	42								
	42								
	46								
1025	42		650/85R42	710/75R42 710/65R46	900/60R42 750/70R44			380/105R50 380/90R54 480/95R50	
	44								
	46								
	50								
1075	50								
1125	46			750/75R46	900/65R46				

Modifying the original fitment of the machine may require a new set of rims.  
Verify that the alternative tire size is fitted on an approved rim contour.

# Load table

## Conversion of load indices (LI) into load capacities per tire (kg)

LI	KG	LI	KG	LI	KG	LI	KG	LI	KG
50	190	85	515	120	1400	155	3875	190	10600
51	195	86	530	121	1450	156	4000	191	10900
52	200	87	545	122	1500	157	4125	192	11200
53	206	88	560	123	1550	158	4250	193	11500
54	212	89	580	124	1600	159	4375	194	11800
55	218	90	600	125	1650	160	4500	195	12150
56	224	91	615	126	1700	161	4625	196	12500
57	230	92	630	127	1750	162	4750	197	12850
58	236	93	650	128	1800	163	4875	198	13200
59	243	94	670	129	1850	164	5000	199	13600
60	250	95	690	130	1900	165	5150	200	14000
61	257	96	710	131	1950	166	5300	201	14500
62	265	97	730	132	2000	167	5450	202	15000
63	272	98	750	133	2060	168	5600	203	15500
64	280	99	775	134	2120	169	5800	204	16000
65	290	100	800	135	2180	170	6000	205	16500
66	300	101	825	136	2240	171	6150	206	17000
67	307	102	850	137	2300	172	6300	207	17500
68	315	103	875	138	2360	173	6500	208	18500
69	325	104	900	139	2430	174	6700	209	19000
70	335	105	925	140	2500	175	6900		
71	345	106	950	141	2575	176	7100		
72	355	107	975	142	2650	177	7300		
73	365	108	1000	143	2725	178	7500		
74	375	109	1030	144	2800	179	7750		
75	387	110	1060	145	2900	180	8000		
76	400	111	1090	146	3000	181	8250		
77	412	112	1120	147	3075	182	8500		
78	425	113	1150	148	3150	183	8750		
79	437	114	1180	149	3250	184	9000		
80	450	115	1215	150	3350	185	9250		
81	462	116	1250	151	3450	186	9500		
82	475	117	1285	152	3550	187	9750		
83	487	118	1320	153	3650	188	10000		
84	500	119	1360	154	3750	189	10300		

# Conversion factors

METRIC UNIT		IMPERIAL UNIT	
1 millimeter (mm)	= 0.03937 inches	1 inch (")	= 25.4 millimeters
1 meter (m)	= 1.09361 yards	1 yard	= 0.9144 meters
1 kilometer (km)	= 0.62137 miles	1 mile (mi)	= 1.609344 kilometers
1 liter (l)	= 0.21997 gallons (UK)	1 gallon (UK)	= 4.5461 litres
1 liter (l)	= 0.26417 gallons (USA)	1 gallon (USA)	= 3.7854 litres
1 gram (g)	= 0.035274 ounces	1 ounce (oz)	= 28.34952 grams
1 kilogram (kg)	= 2.205 pounds	1 pound (lb)	= 0.45359 kilograms
1 kilometer per hour (km/h)	= 0.62137 miles per hour	1 mile per hour (mph)	= 1.609344 kilometers per hour
1 kilopascal (kPa)	= 0.145 pounds per square inch	1 pound per square inch (psi)	= 6.895 kilopascal
1 bar	= 100 kilopascal	1 pound per square inch (psi)	= 0.06895 bar
1 kilowatt (kW)	= 1.34 horsepower	1 horsepower (HP)	= 0.746 kilowatts
1 Newton meter (N.m)	= 0.113 inch pound	1 inch pound (in-lb)	= 8.85 inch-pound

## Temperatures

(Fahrenheit - 32) x 0.55 = Celsius	32	40	50	60	70	75	85	95	105	140	175	212	°F
(Celsius x 1.8) + 32 = Fahrenheit	0	5	10	15	2	25	30	35	40	60	80	100	°C

## Speed

Speed code	A1	A2	A3	A4	A6	A8	B	C	D	E	F	J
km/h	5	10	15	20	30	40	50	60	65	70	80	100
mph	3	6	9	12	19	25	31	37	40	43	50	62

km/h to mph x 0,62    mph to km/h x 1,61

## Pressures

kPa (kilopascal)	60	100	120	140	160	180	200	240	280	320	360	400	500
bar = kg/cm <sup>2</sup>	0,6	1,0	1,2	1,4	1,6	1,8	2,0	2,4	2,8	3,2	3,6	4,0	5,0
psi = (pound/square inches)	9	14	17	20	23	26	29	35	41	46	52	58	72

psi to bar x 0,06895    bar to psi x 14,50326    kPa to bar x 100,00    bar to kPa x 0,01    kPa to psi x 7,00    psi to kPa x 0,142

# Mechanical lead

In order to fully exploit the advantages of 4 wheel drive and to avoid premature wear of transmission and tires, the peripheral speed of the front axle must be higher than the rear.

The “**MECHANICAL LEAD**” (**L**) is the percentage relative ratio between the peripheral speeds of the front and rear tires.

Commonly, the correct advancement of the tractor with double traction foresees a value of **L** included between +1 and + 5% (peripheral speed of front tires > peripheral speed rear tires).

Values of **L** out of this range could cause problems of handling instability (**L < 1**, the rear axle “pushes” the tractor in excessive way respect to the frontal axle) or cause excessive creeping between the front and rear tires (**L > 5**, excessive mechanic effort of all the transmission chain). In both the cases, rises difficulty in the management / insertion of the “gears” and **the tires are subjects to rapid and uneven wears.**

## Calculation of the front lead

The measure must be implemented with the following conditions:

- tractor equipped with standard front ballast
- nominal tires pressure
- tract of smooth and level surface at least 50 m.

$$A = \frac{Rc \text{ (front)} * RM - Rc \text{ (rear)}}{Rc \text{ (rear)}} * 100 = (+1 \text{ } +5)$$

where:      Rc (front) = rolling circumference of front axis tires  
              Rc (rear) = rolling circumference of rear axis tires  
              RM       = mechanical ratio between front and rear axle

## Measure of the rolling circumference on the field

The measure must be calculated in the following way:

- remove the double traction (the rolling of the front and rear wheels have to be independent)
- mark the front and rear tires sidewall, on the middle of the tire-foot print area
- mark the rolling surface in correspondence of the middle of the tire-foot print area
- move the tractor forward so that the front and rear tire complete exactly 5 revolutions
- mark on the rolling surface the point at the end of the 5th revolution, respectively for the front and rear tires
- measure the distance crossed respectively to the front (f) and rear (r) tires

- **CALCULATION OF Cr (front)** =  $F[m] / n^\circ$  of revolutions =  $a / 5$

- **CALCULATION OF Cr (rear )** =  $R[m] / n^\circ$  of revolutions =  $p / 5$

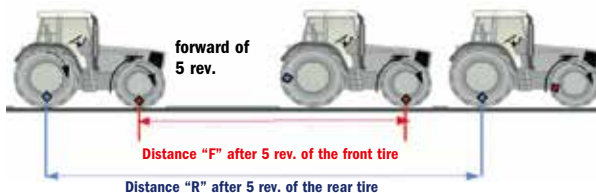

## Measure of the mechanical ratio on the field

The measure must be implemented in the following way:

- insert the double traction
- mark the front and rear tires sidewall, on the middle of the tire footprint area
- move the tractor forward so that the rear tire complete exactly 5 revolutions
- count the complete number of revolutions of the front tire
- calculate the fraction of revolution of the front tire in this way: count the number of lugs included between the one in the middle of the foot print area and the previously taken as reference point. Divide this counted number by the total lugs number

**CALCULATION OF RM** = (front tire revolutions + rev. fraction) / complete rear tire revolutions

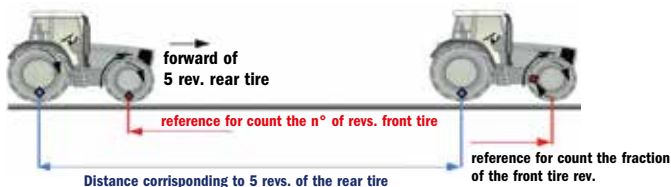

# Liquid ballasting

Occasionally the machine needs extra weight to increase tractive power but also to lower the centre of gravity for improved stability. Primary, wheel or chassis mounted weights should be used, but on occasions when this is impossible, the tires can be liquid filled.

Liquid filling alters tire characteristics:

- tires get more rigid and less flexible
- rolling resistance increases
- increased risk of damage to tires, rims and axles
- considerably increased forces during road operations

## Liquid recommendations

In areas without any risk of freezing:

- tubed tires - water only
- tubeless tires - water + anti corrosion fluid, usually ethylene glycol

In areas with a risk of freezing:

- tubed tires - water + calcium-chloride ( $\text{CaCl}_2$ ) or ethylene glycol or methylated spirit
- tubeless tires - water + ethylene glycol

These solutions lower the freezing point and do not damage the tire, while the calcium chloride also increases the ballasting.

## Liquid precautions

- Use pumps with rust resistant pressure gauges.
- Ensure the operator uses protective glasses, overalls, boots and rubber gloves.
- Prepare the solution by pouring the calcium chloride into the water and stirring the mix to help it dissolve.

**Never pour the water into the calcium chloride: it is dangerous. Always mix calcium chloride in to water.**

- Clean all the metal parts of the vehicle carefully when the filling or drainage operations are complete, as they may have come into contact with the anti-freeze, which is corrosive.
- Check tire pressure frequently as the quantity of air remaining in the tire is low.

## Liquid volume

Maximum permitted filling volume is 75% of the total tire volume. For forestry machines, operating in heavy terrain, max. 50% filling volume.

# Liquid ballasting Radial

Size	Litres of solution or total water (kg) (at valve level= 75%)	Solution (up to -20°C)			Solution (up to -40°C)		
		Quantity CaCl <sub>2</sub> (kg)	Volume of water ( l )	Total mass (Kg)	Quantity CaCl <sub>2</sub> (kg)	Volume of water ( l )	Total mass (kg)
VF 620/70R26	391	93	352	445	191	297	488
VF 520/60R28	228	54	204	258	111	172	283
VF 600/60R28	327	78	293	371	160	248	408
VF 600/65R28	347	83	311	394	169	263	432
VF 540/65R30	289	78	260	335	142	220	361
VF 600/70R30	428	102	384	486	209	324	533
VF 600/60R30	340	81	306	387	166	258	424
IF 600/70R30	428	102	384	486	209	324	533
VF620/75R30	505	121	454	575	247	383	630
IF 800/65R32 CFO	825	198	742	940	404	627	1031
IF 800/70R32 CFO	927	222	834	1056	454	704	1158
IF 650/60R34	455	109	409	518	223	345	568
VF 650/60R34	455	109	409	518	223	345	568
IF 650/65R34	512	122	460	582	250	389	639
IF 710/60R34	575	138	517	655	281	437	718
VF 420/85R34	265	72	238	307	130	201	331
VF 600/60R38	406	97	365	462	198	308	506
VF 650/60R38	490	117	440	557	239	372	611
IF 650/65R38	548	131	493	624	268	416	684
IF 710/60R38	607	145	546	691	297	461	758
VF 710/60R38	607	145	546	691	297	461	758
IF 800/70R38 CFO	1035	248	931	1179	507	786	1293
VF 800/70R38	1035	248	931	1179	507	786	1293
VF 650/85R38	832	199	749	948	407	632	1039
VF 710/60R42	654	157	588	745	320	497	817
VF 650/65R42	615	147	553	700	301	467	768
IF 710/70R42	813	195	731	926	398	617	1015
VF 710/70R42	813	195	731	926	398	617	1015
IF 710/75R42	904	217	813	1030	443	687	1130
VF 710/75R42	904	217	813	1030	443	687	1130
IF 900/60R42	1167	279	1049	1328	571	886	1457
VF 380/85R46	245	58	220	278	120	186	306
VF 380/90R46	285	68	256	324	139	216	355
VF 380/105R46	352	84	316	400	172	267	439
VF 380/105R50	375	90	337	427	183	285	468
IF 710/65R46	764	183	687	870	374	580	954
IF 750/75R46	1101	264	991	1255	539	837	1376
IF 900/65R46	1401	336	1260	1596	686	1064	1750
VF 900/65R46	1401	336	1260	1596	686	1064	1750
VF 480/80R50	451	108	406	523	221	344	602
VF 480/95R54	735	176	661	837	360	558	918

Size	Litres of solution or total water (kg) (at valve level= 75%)	Solution (up to -20°C)			Solution (up to -40°C)		
		Quantity CaCl <sub>2</sub> (kg)	Volume of water ( l )	Total mass (kg)	Quantity CaCl <sub>2</sub> (kg)	Volume of water ( l )	Total mass (kg)
320/65R18	55	13	49	62	26	41	79
340/65R18	64	15	57	72	31	48	79
440/65R24	151	41	136	175	74	115	189
480/65R24	187	51	169	217	92	142	234
540/65R24	247	67	223	287	121	188	309
540/65R26	270	65	254	313	132	205	340
440/65R28	169	46	152	196	83	129	212
480/65R28	206	56	186	239	101	157	258
540/65R28	275	74	248	319	135	209	344
600/65R28	363	98	326	421	178	276	453
540/65R30	289	78	260	335	142	220	361
800/65R32	843	202	758	960	413	640	1053
540/65R34	317	86	285	368	155	241	396
600/65R34	420	100	378	478	205	319	524
540/65R38	342	92	308	397	168	260	428
600/65R38	446	120	401	517	218	339	557
650/65R38	541	146	487	628	265	411	677
600/65R42	481	130	433	558	236	366	602
650/65R42	582	157	524	675	285	442	727

Size	Litres of solution or total water (kg) (at valve level= 75%)	Solution (up to -20°C)			Solution (up to -40°C)		
		Quantity CaCl. (kg)	Volume of water ( l )	Total mass (kg)	Quantity CaCl. (kg)	Volume of water ( l )	Total mass (kg)
710/60R30	519	124	467	591	254	394	648
900/60R32	1005	241	904	1145	492	764	1256
650/60R34	444	106	399	505	217	337	554
710/60R34	566	135	509	644	277	430	707
900/60R38	1082	259	973	1232	530	822	1352
900/60R42	1159	278	1043	1321	568	881	1449

Size	Litres of solution or total water (kg) (at valve level= 75%)	Solution (up to -20°C)			Solution (up to -40°C)		
		Quantity CaCl. (kg)	Volume of water ( l )	Total mass (kg)	Quantity CaCl. (kg)	Volume of water ( l )	Total mass (kg)
240/70R16	28	6	25	31	13	21	34
260/70R16	33	9	30	38	16	25	41
280/70R16	41	11	37	47	20	31	51
280/70R18	44	12	40	52	22	33	55
280/70R20	48	11	42	53	23	36	59
300/70R20	55	15	50	64	27	42	69
320/70R20	70	19	63	81	34	53	88
360/70R20	93	25	84	108	46	71	116
380/70R20	113	30	102	131	55	86	141
320/70R24	85	23	77	98	42	65	106
360/70R24	100	27	90	116	49	76	125
380/70R24	130	35	117	151	64	99	163
420/70R24	166	44	149	193	81	126	208
480/70R24	213	58	192	247	104	162	266
480/70R26	231	71	208	273	113	176	289
320/70R28	94	25	85	110	46	71	118
360/70R28	122	33	110	141	60	93	153
380/70R28	144	38	130	167	71	109	180
420/70R28	185	50	167	215	91	141	231
480/70R28	225	60	203	261	110	171	281
600/70R28	398	95	357	452	194	302	496
420/70R30	196	53	176	228	96	149	245
480/70R30	256	69	230	296	125	195	320
520/70R30	320	86	288	371	157	243	400
600/70R30	417	99	374	473	204	316	520
480/70R34	285	77	257	331	140	217	356
520/70R34	350	95	315	406	172	266	438
600/70R34	455	109	409	518	222	345	567
480/70R38	310	84	279	360	152	236	388
520/70R38	380	103	342	441	186	289	475
580/70R38	498	134	448	578	244	378	623
710/70R38	760	205	684	882	372	578	950
800/70R38	1022	245	919	1164	500	776	1276
580/70R42	519	140	467	602	254	394	649
620/70R42	589	159	530	683	289	448	736
710/70R42	800	192	720	912	392	608	1000



Size	Litres of solution or total water (kg) (at valve level= 75%)	Solution (up to -20°C)			Solution (up to -40°C)		
		Quantity CaCl <sub>2</sub> (kg)	Volume of water ( l )	Total mass (kg)	Quantity CaCl <sub>2</sub> (kg)	Volume of water ( l )	Total mass (kg)
620/75R26	480	115	432	547	235	365	600
650/75R32	596	143	536	679	292	453	745
710/75R32	762	182	685	867	373	579	952
650/75R38	698	167	628	795	342	530	872
710/75R42	921	221	829	1068	451	700	1160

Size	Litres of solution or total water (kg) (at valve level= 75%)	Solution (up to -20°C)			Solution (up to -40°C)		
		Quantity CaCl <sub>2</sub> (kg)	Volume of water ( l )	Total mass (kg)	Quantity CaCl <sub>2</sub> (kg)	Volume of water ( l )	Total mass (kg)
280/85R20	66	18	60	77	32	50	83
320/85R20	92	25	83	107	45	70	115
280/85R24	75	20	68	87	37	57	94
320/85R24	104	28	94	121	51	79	130
340/85R24	121	33	109	141	59	92	152
380/85R24	160	43	144	186	78	122	200
420/85R24	211	57	190	245	103	160	264
280/85R28	85	23	76	98	41	64	106
320/85R28	117	31	105	135	57	89	146
340/85R28	136	37	122	157	67	103	170
380/85R28	178	48	160	207	87	135	223
420/85R28	234	63	211	271	115	178	292
380/85R30	188	51	169	218	92	143	234
420/85R30	241	65	217	280	118	183	301
460/85R30	299	81	269	347	147	227	374
380/85R34	205	49	185	238	100	156	258
420/85R34	265	72	238	307	130	201	331
460/85R34	327	88	295	380	160	249	409
320/85R38	152	36	137	176	74	116	192
340/85R38	172	46	155	200	84	131	215
380/80R38	197	47	176	223	96	149	245
380/85R38	224	61	202	260	110	171	280
400/75R38	205	49	184	233	100	155	255
420/85R38	288	78	259	334	141	219	360
460/85R38	355	96	319	411	174	270	443
520/85R38	484	131	435	561	237	367	604
650/85R38	832	199	749	948	407	632	1039
520/85R42	523	141	471	607	256	398	654
480/80R42	389	93	350	451	191	296	490
480/80R46	416	100	374	483	204	316	524
520/85R46	554	133	509	278	117	182	300
480/80R50	451	108	406	523	221	344	602

Size	Litres of solution or total water (kg) (at valve level= 75%)	Solution (up to -20°C)			Solution (up to -40°C)		
		Quantity CaCl. (kg)	Volume of water ( l )	Total mass (kg)	Quantity CaCl. (kg)	Volume of water ( l )	Total mass (kg)
230/95R32	69	19	62	80	34	52	86
270/95R32	96	26	86	112	47	73	120
230/95R36	77	21	69	89	38	59	96
270/95R38	118	28	106	134	58	89	147
210/95R44	75	20	68	87	37	57	94
230/95R44	91	25	82	106	45	69	114
270/95R44	125	34	113	145	61	95	156
300/95R46	175	47	158	203	86	133	219
230/95R48	91	25	82	105	45	69	114
270/95R48	140	38	126	162	69	106	175
380/90R50	290	70	261	337	142	221	387
300/95R52	198	47	178	225	97	150	247
380/90R54	310	74	279	360	152	237	413

Size	Litres of solution or total water (kg) (at valve level= 75%)	Solution (up to -20°C)			Solution (up to -40°C)		
		Quantity CaCl. (kg)	Volume of water ( l )	Total mass (kg)	Quantity CaCl. (kg)	Volume of water ( l )	Total mass (kg)
500/60R22.5	203	49	183	235	99	154	256
560/60R22.5	247	67	222	287	121	188	309
580/65R22.5	301	81	271	349	147	229	376
600/50R22.5	240	58	221	278	117	182	300
600/55R26.5	320	77	288	371	157	243	403
680/55R26.5	385	104	347	447	189	293	481
710/50R26.5	380	91	342	433	187	289	476
750/60R30.5	675	162	608	783	331	513	851
650/65R30.5	533	128	480	618	261	405	672
850/50R30.5	702	168	632	814	344	534	885

Size	Litres of solution or total water (kg) (at valve level= 75%)	Solution (up to -20°C)			Solution (up to -40°C)		
		Quantity CaCl. (kg)	Volume of water ( l )	Total mass (kg)	Quantity CaCl. (kg)	Volume of water ( l )	Total mass (kg)
12.4R36	129	30	115	145	63	97	160
13.6R36	176	42	158	200	86	134	220
7.50R20	39	9	34	43	19	29	48
8.3R24	39	9	34	43	18	29	47
9.5R20	48	11	43	54	23	36	59
9.5R24	55	13	49	62	26	41	67

Size	Litres of solution or total water (kg) (at valve level= 75%)	Solution (up to -20°C)			Solution (up to -40°C)		
		Quantity CaCl. (kg)	Volume of water ( l )	Total mass (kg)	Quantity CaCl. (kg)	Volume of water ( l )	Total mass (kg)
340/80R18	91	21	81	102	44	68	112
400/70R18	114	27	102	129	55	86	141
400/70R20	122	29	110	139	59	93	152
400/70R24	139	33	125	158	68	105	173
440/80R24	169	40	152	192	82	128	210
460/70R24	195	46	175	221	95	148	243
500/70R24	241	57	217	274	118	183	301
480/80R26	280	67	252	319	137	212	349
440/80R28	239	57	214	271	116	181	297

# Liquid ballasting Cross-ply

Size	Litres of solution or total water (kg) (at valve level= 75%)	Solution (up to -20°c)			Solution (up to -40°c)		
		Quantity CaCl. (kg)	Volume of water ( l )	Total mass (kg)	Quantity CaCl. (kg)	Volume of water ( l )	Total mass (kg)
<b>Twin Tractor</b>							
400/55-17.5	85	20	77	99	42	65	106
600/55-26.5	315	76	284	365	154	239	394
500/60-26.5	220	53	198	255	108	167	275
600/55-30.5	345	83	311	400	169	262	431
600/60-30.5	380	91	342	441	186	289	475
750/45-30.5	410	98	369	476	201	312	513
800/55-30.5	740	178	666	858	363	562	925
900/60-32	990	238	891	1148	485	752	1238
710/65-38	695	167	626	806	341	528	869
850/50-38	885	212	797	1027	434	673	1106
850/60-38	1050	252	945	1218	515	798	1313
850/55-42	955	229	860	1108	468	726	1194
<b>Twin Implement</b>							
280/60-15.5	45	11	41	52	22	34	56
400/45-15.5	57	13	51	64	27	43	70
400/60-15.5	92	22	82	104	45	69	114
420/55-17	93	22	83	105	45	70	115
400/55-17.5	85	20	77	99	42	65	106
400/55-22.5	110	26	99	128	54	84	138
500/45-22.5	140	34	126	162	69	106	175
500/60-22.5	225	54	203	261	110	171	281
560/45-22.5	180	43	162	209	88	137	225
560/60-22.5	270	65	243	313	132	205	338
600/50-22.5	265	64	239	307	130	201	331
710/40-22.5	305	73	275	354	149	232	381
400/60-26.5	160	38	144	186	78	122	200
500/60-26.5	265	64	239	307	130	201	331
710/45-26.5	370	89	333	429	181	281	463
800/40-26.5	455	109	410	528	223	346	569
600/60-30.5	380	91	342	441	186	289	475
650/65-30.5	516	123	464	587	253	392	645
710/50-30.5	460	110	414	534	225	350	575
750/60-30.5	702	168	631	799	343	533	876
800/45-30.5	540	130	486	616	265	410	675
850/50-30.5	773	185	695	880	378	587	965
<b>Twin AMPT</b>							
620/50B22.5	265	64	239	307	130	201	331
650/45B22.5	245	59	221	284	120	186	306
710/40B22.5	305	73	275	354	149	232	381
620/55B26.5	320	77	288	371	157	243	400
650/55B30.5	380	91	342	441	186	289	475
750/50B30.5	460	110	414	534	225	350	575
850/45B30.5	627	150	564	714	307	476	783
<b>Twin Garden Tractor</b>							
350/60-17.5	69	16	62	78	33	52	85
400/55-17.5	85	20	77	99	42	65	106
400/55-22.5	110	26	99	128	54	84	138
500/45-22.5	140	34	126	162	69	106	175
500/60-22.5	225	54	203	261	110	171	281

Size	Litres of solution or total water (kg) (at valve level= 75%)	Solution (up to -20°C)			Solution (up to -40°C)		
		Quantity CaCl. (kg)	Volume of water ( l )	Total mass (kg)	Quantity CaCl. (kg)	Volume of water ( l )	Total mass (kg)
<b>Twin Garden Tractor</b>							
560/45-22.5	180	43	162	209	88	137	225
560/60-22.5	270	65	243	313	132	205	338
23.1-26	495	119	446	574	243	376	619
600/60-30.5	380	91	342	441	186	289	475
<b>Agroforest</b>							
320/85-24	105	25	94	119	51	80	131
380/85-24	155	37	139	176	76	61	137
380/85-28	170	40	153	193	83	129	212
420/85-28	225	54	202	256	110	171	282
420/85-30	235	56	211	267	115	178	293
460/85-30	310	74	279	353	152	235	387
420/85-34	265	63	238	301	130	201	331
460/85-34	335	80	301	381	164	254	418
420/85-38	275	66	247	313	134	209	343
460/85-38	345	82	310	392	169	262	431
520/85-38	470	112	423	535	230	357	587

# Liquid ballasting Forestry

Size	Litres of solution or total water (Kg) (at valve level= 75%)	Solution (up to -20°C)			Solution (up to -40°C)		
		Quantity CaCl. (Kg)	Volume of water ( l )	Total mass (Kg)	Quantity CaCl. (Kg)	Volume of water ( l )	Total mass (Kg)
<b>Twin Forestry (*)</b>							
400/60-15.5	61 / 92	14 / 22	55 / 82	69 / 104	30 / 45	46 / 69	76 / 114
500/45-22.5	94 / 140	23 / 34	85 / 126	109 / 162	46 / 69	71 / 106	118 / 175
500/60-22.5	150 / 225	36 / 54	135 / 202	174 / 261	73 / 110	114 / 171	188 / 281
600/50-22.5	160 / 240	38 / 57	144 / 216	182 / 273	78 / 117	121 / 182	199 / 299
650/45-22.5	162 / 244	39 / 58	146 / 219	185 / 277	79 / 119	123 / 185	202 / 304
710/40-22.5	202 / 304	48 / 73	182 / 274	234 / 353	99 / 149	153 / 231	253 / 380
600/50-24.5	160 / 240	38 / 57	144 / 216	182 / 273	78 / 117	121 / 182	199 / 299
710/40-24.5	190 / 285	45 / 68	171 / 256	216 / 324	93 / 139	144 / 216	237 / 355
400/60-26.5	85 / 128	20 / 30	76 / 115	96 / 145	41 / 62	64 / 97	105 / 159
500/60-26.5	147 / 219	35 / 53	132 / 197	171 / 254	72 / 107	112 / 166	184 / 274
600/55-26.5	210 / 315	50 / 76	189 / 283	244 / 365	103 / 154	160 / 239	263 / 394
650/60-26.5	215 / 321	52 / 77	194 / 289	249 / 372	105 / 157	163 / 244	269 / 401
710/45-26.5	245 / 370	59 / 89	221 / 333	284 / 429	120 / 181	186 / 281	306 / 463
750/50-26.5	320 / 475	77 / 114	288 / 427	371 / 551	157 / 233	243 / 361	400 / 594
750/55-26.5	335 / 502	80 / 120	301 / 451	381 / 571	163 / 245	254 / 381	417 / 626
800/40-26.5	231 / 346	55 / 83	207 / 311	262 / 394	113 / 169	175 / 263	288 / 432
780/50-28.5	347 / 521	83 / 124	312 / 468	395 / 592	170 / 255	263 / 395	433 / 650
600/60-30.5	255 / 380	61 / 91	230 / 342	296 / 441	125 / 186	194 / 289	319 / 475
620/55-30.5	235 / 350	56 / 84	212 / 315	273 / 406	115 / 172	179 / 266	294 / 438
710/50-30.5	315 / 470	75 / 113	285 / 425	367 / 548	155 / 232	359 / 241	590 / 396
750/45-30.5	300 / 450	72 / 108	270 / 405	348 / 522	147 / 221	228 / 342	375 / 563
600/65-34	304 / 455	73 / 109	274 / 409	353 / 528	149 / 223	231 / 346	380 / 569
710/55-34	377 / 565	90 / 136	339 / 508	437 / 655	185 / 277	286 / 429	471 / 706
750/65-34	487 / 731	117 / 175	438 / 658	565 / 848	239 / 358	370 / 556	609 / 914

(\*): max 50% filling volume for tire operating in heavy terrain

# Tire fitting and removal instructions

Tire fitting and removal procedures can be dangerous and should only be performed by trained and qualified staff, using the appropriate tools and procedures. Failure to comply with these procedures may result in the tire being incorrectly seated on the rim and could cause a rapid deflation, potentially leading to serious physical injury or death. Always wear personal protection equipment such as gloves, footwear, eye protection, hearing protection and head gear, when servicing tire and wheels.

## Fitting (remove procedure)

1. Make sure that the rim, the tire and the tube are compatible.
2. Check that the tire is suitable for the machine. The seat diameter of the rim must be exactly the same as the seat diameter of the tire to be mounted. Use only rims recommended or permitted by the tire manufacturer (see characteristics in the Manufacturer's data book).
3. Always use the proper specialized equipment and tools, in good condition, not sharp and suitable for the tires and rims.
4. The rim must be clean and in perfect condition. If necessary, clean the rim thoroughly with a wire brush. Never fit a tire onto a rim that shows cracks, significant distortion or evidence of welded repair.

5. Thoroughly inspect the inside as well as the outside of the tire to identify any deterioration or damage which may be present. If the damage or deterioration is considered not repairable, the tire should be appropriately disposed of.
6. For TUBE TYPE tire: always use the correct new tube (and flap if required) for the tire size (see characteristics in the Manufacturer's data book).  
For TUBELESS tire: always use a new tubeless valve correctly tightened on tubeless rims.
7. Before fitting the tire, apply lubricant to the rim and the beads. Use only a suitable lubricant that will not damage the tire and is suitable for operation.  
NOTE: never use silicone or petroleum-based products.
8. We recommend vertical fitting. In case of manual horizontal fitting, pay attention to check if the lower bead is correctly seated.
9. Position the valve or valve hole at the bottom, fitting the tire on the rim diametrically opposite to the valve hole.
10. Respect, if present, the rotation direction indicated by the arrows.
11. If there is the low spot marking on the sidewall of the tire, position the tire so that the symbol is as close as possible to the high spot marking on the rim if present. This will optimize the matching between tire and rim.
12. With the help of a suitable lever and with closely repeated applications, get the first bead over the rim flange. Position the slightly inflated tube inside the tire, then locate and secure the valve, tightening the nut moderately



1. Bead
2. Bead seat
3. Bead seat well

(when mounting with an inner tube).

Fit the second bead, lever it progressively over the rim flange.

13. Center the tire on the rim and slowly inflate to ensure correct seating of the beads. Ensure that the beads do not pinch the tube.

14. During the tire inflation keep a safe distance and always use a safety cage. If possible, anchor it to the wall and/or the floor, or with retaining chains.

If no cage is available, the fitter must ensure that no part of his body is in the possible trajectory of the valve mechanism or the caps during inflation. (See the shaded area shown in figures 1,2,3).

It is recommended to use suitable pressure limitation gauges. Use a filter and dehumidifier on the compressed air line to avoid introducing humidity or dirt.



figure 1



figure 2



figure 3

15. Inflate the tire until the beads are seated properly on the rim. Do not exceed the maximum mounting pressure indicated on the sidewall tire pictogram (250 kPa – 350 kPa –500 kPa).



16. If the beads are not correctly seated, deflate, reapply the lubricant and inflate again. Repeat this process until the beads are correctly seated.

17. When all the previous steps have been correctly followed, refit the valve core. Set the pressure according to appropriate shipment pressure values or service pressure (see tables in technical databook) before removal from the safety device.

18. Make sure the valves do not touch the rims, the brake drums or other fixed mechanical parts.

## Removal

**Never try to unseat the beads of an inflated tire.**

**Never use tools that could damage the rims or the beads of the tire.**

1. Deflate the tire. After deflating, remove the wheel nut and push the valve through the valve hole (for tube type tires).
2. When the tire is completely deflated, place an hydraulic “bead unseating” tool between the tire bead and rim flange and force the bead off the bead seat.
3. Carefully lubricate the tire bead and the rim flange area with an appropriate fitting lubricant. Push the outside bead at the bottom of the wheel into the well. Do not use excessive force. Insert tire lever under the bead at the top of the wheel and carefully pry the bead over the rim flange.
4. Hold that bead section over the flange with a tire lever and use another one to pry the next section over the flange until the complete unseating of the bead.
5. To remove the tire completely from the rim, insert the tire lever under the inside bead. Carefully pry the rest of the inside bead over the rim flange, ensuring that the bead area at the top of the tire is down in the well of the rim.



# Use and maintenance

Tires are the only contact between the vehicle and the ground. It is therefore of paramount importance that tires must always be maintained in good condition and when the time comes to change them, the correct replacements are fitted.

The tires fitted to your vehicle as original equipment were selected by the vehicle and tire manufacturers considering all aspects of the vehicle's operation. Changes in tire size, structure, load and speed rating should not be made without first seeking advice from the tire or vehicle manufacturer. Failing to do so may impact on safety, vehicle behavior as well the clearance which needs to be considered.

During the usage:

- Adapt driving manner and speed to the vehicle load, the environmental conditions and the road surface.
- Avoid overload, either total or localized, with a suitable load distribution. Overload can greatly affect the tire's life.
- After tire fitment, check nuts are still tight after 3 hours of use and then subsequently at regular intervals.
- Use a proper gauge, calibrated and checked regularly
- Do not allow the tire to stand on hydrocarbons in general. For example, oil, Diesel or grease.
- The tires on a vehicle should be examined paying attention to:
  - Tread: Check for evidence of abnormal wear, cuts, localized

deformities and foreign bodies such as grit or scrap metal.

- Sidewalls: for cuts, cracks, impact damage, and localized deformities
  - Bead/rim flange area: for signs of chafing, rim damage, mis-fitment
  - Between twin tires (for dual application): for cracks, abrasion, localized deformities and foreign bodies
- If there are objects lodged between the duals, firstly deflate both tires.
  - In case of any such damage, the tire must be checked by a specialist.
  - A tire specialist should be also consulted if a tire has suffered a heavy impact, even if there is no visible sign of damage. Any damage could potentially reduce the life of the tire
  - In case of a puncture, it is imperative to stop using the tire as soon as possible. Operating under inflated may cause structural deterioration.
  - A tire which has been punctured must always be removed from the wheel to be checked for secondary damages.
  - If a repair to a tire is necessary and feasible, it must be carried out by a tire specialist as soon as possible in order to avoid further deterioration of the structure.
  - In all cases, tire repairs must be carried out by a qualified tire specialist.

- Tires are subject to ageing even if they have not been used or have only been used occasionally. Cracking of the tread and/or sidewall rubber, sometimes accompanied by carcass deformation, is evidence of ageing. Old and aged tires must be checked by tire specialists to ensure their suitability for further use.

- Tires fitted to vehicles that are parked for long periods will tend to age and crack more quickly than those that are used and run frequently. In such circumstances it is important to jack the weight off the tires and protect the tire from direct sunlight.

## Storage

- Keep the tires away from heat and ozone sources.
- Avoid prolonged exposure of the tires to direct sunlight.
- Avoid any contact with grease, petrol, volatile solvents or other substances that may deteriorate the rubber.
- Avoid horizontal storage for tubeless tires (whether radial or cross-ply); only small size tires may be stacked or stored horizontal (for a maximum of 6 months).

- When tires are stored horizontally, the position must be lug against lug.
- Reduce inflation pressure when tires are stored fitted on rims.
- Turn over stock constantly.
- Ensure there is no water or moisture inside the tire.
- Inner tubes and flaps must never be hung up, but always stored on shelves.

# Others

- Tires age, even if they have not been used or have only been used occasionally. Cracking of the tread sidewall rubber, sometimes accompanied by casing deformation, is evidence of ageing. Old and aged tires must be checked by tire specialists to ascertain their suitability for further use.
- Tires fitted to vehicles that are parked for long periods will tend to age a crack more quickly than those that are used and run frequently. In such circumstances it is important to jack the weight off the tires and protect the tire from direct sunlight.

# General information about inflation pressure, fitting and handling of forest tires

The inflation pressure affects the service life of the tire and the performance of the machine. To guarantee the tire's function and to provide margins for the extra stress a tire in forest service is exposed to, the inflation pressure should be chosen carefully.

Machine specific inflation pressure recommendations are based on a fully loaded machine, according to the manufacture's stated load, plus a dynamic marginal.

The recommendations indicate minimal- normal- and maximum inflation pressure. For estimation, see headline "The inflation pressure's effects".

## The inflation pressure should be adjusted to the terrain conditions and load

Use a lower pressure if the terrain is relatively rock free and where greater bearing capacity is required.

Use a higher pressure for heavy service in demanding terrain.

If a machine specific recommendation is missing, the inflation pressure should be adjusted to the load that the tire is exposed to in kilograms (machine weight + load) and terrain conditions.

For more information, contact Trelleborg.

### The inflation pressure's effects

	<b>Advantages</b>	<b>Disadvantages</b>
<b>Low inflation pressure</b>	<ul style="list-style-type: none"> <li>Good comfort</li> <li>Large contact surface</li> <li>Lower ground pressure</li> <li>Less soil damage</li> <li>Increased traction</li> </ul>	<ul style="list-style-type: none"> <li>Reduced stability</li> <li>Increased risk of tube damage/wear</li> </ul>
<b>High inflation pressure</b>	<ul style="list-style-type: none"> <li>Increased stability</li> <li>Requirement when using tracks</li> </ul>	<ul style="list-style-type: none"> <li>Reduced comfort</li> <li>Increased risk of cuts and puncture damage to the lug tread</li> <li>Increased sensitivity to point loads</li> <li>Increased soil damage and ruts</li> <li>Less grip</li> </ul>

### **Inflation pressure check**

The tires must be visually checked daily and the inflation pressure must be checked at least once a month.

A tire that has been removed should be checked regularly during the first week after it has been refitted. This is because there might be air pockets between the tire and tube that ventilate out, and reduce the inflation pressure. Wheels with liquid ballast must be checked more frequently as the volume of air in the tire is smaller.

The inflation pressure becomes lower if the temperature drops. Example: inflated to 4 bar in the workshop (+20° Celcius) the pressure will become 3,5 bar when outside in the winter (- 20° Celcius). Pressure loss is 13,7% /40 degrees. The opposite will occur when it becomes warmer. (The calculation is valid for constant tire volume). Ensure adjustments are made for this.

### **Driving with tracks**

Use the recommended inflation pressure for track use. Check that the tracks are correctly tensioned. The tracks must sag approximately 50 mm between the wheels.

Check that the tracks fit the tires. On one side, there must be a distance of approximately 15 mm between the track's side support and the tire.

### **Driving with chains**

Use of chains does not affect the inflation pressure.





### **Tire maintenance**





Regular inspection and maintenance of the tires increases service life.

During the daily visual inspection of the tires, it is important to note any damage, such as splinters and large gashes or pin hole damage that causes moisture to penetrate the tire shell. Any such damage should be repaired without causing a separation (external rubber releasing from the tire shell). Check the tension of the anti-slide devices, and make sure that they do not have any loose links or sharp parts that can damage the tires.

Remove any branches or wood splinters that have got trapped between the tire and rim.

# TWIN Forestry Inflation pressure recommendation

Machine	Pattern			Inflation pressure													
Forwarders																	
	Tire size / LI	T480	T440	T428	Front			Rear			With track usage						
					Min	Normal	Max	Min	Normal	Max	bar	p.s.i.	bar	p.s.i.			
bar p.s.i.													bar p.s.i.				
9 - 10 tons load. Forwarder 8 w. Machine weight 10.500 - 13.000 kg without load																	
600/50-22.5 149A8	Front/Rear		Front/Rear	2,0	3,0	2,4	3,5	2,8	4,0	3,1	4,6	3,7	5,4	4,2	6,1	5,0	7,3
710/40-22.5 151A8	Front/Rear		Front/Rear	1,9	2,7	2,2	3,2	2,5	3,7	3,0	4,3	3,5	5,1	4,0	5,8	5,0	7,3
650/45-22.5 150A8		Front/Rear		1,9	2,7	2,2	3,2	2,5	3,7	3,0	4,3	3,5	5,1	4,0	5,8	5,0	7,3
12 - 13 tons load. Forwarder 6 w. Machine weight 13.000 - 15.000 kg without load																	
600/65-34 157A8		Front		1,9	2,7	2,2	3,2	2,5	3,7	-	-	-	-	-	-	-	-
710/55-34 161A8		Front		1,7	2,5	2,0	2,9	2,3	3,3	-	-	-	-	-	-	-	-
600/55-26.5 165A8		Rear	Rear	-	-	-	-	-	-	3,1	4,6	3,7	5,4	4,3	6,2	6,0	8,7
710/45-26.5 163/168A8	Rear	Rear	Rear	-	-	-	-	-	-	3,0	4,3	3,5	5,1	4,0	5,8	6,0	8,7
12 - 13 tons load. Forwarder 8 w. Machine weight 14.000 - 16.000 kg without load																	
600/55-26.5 165A8	Front/Rear	Front/Rear	Front/Rear	2,2	3,2	2,6	3,8	3,0	4,3	3,1	4,6	3,7	5,4	4,3	6,2	6,0	8,7
710/45-26.5 163/168A8	Front/Rear	Front/Rear	Front/Rear	2,0	3,0	2,4	3,5	2,8	4,0	3,0	4,3	3,5	5,1	4,0	5,8	6,0	8,7
14 - 15 tons load. Forwarder 6 w. Machine weight 14.500 - 16.500 kg without load																	
600/65-34 157A8		Front		2,0	3,0	2,4	3,5	2,8	4,0	-	-	-	-	-	-	-	-
710/55-34 161A8		Front		1,9	2,7	2,2	3,2	2,5	3,7	-	-	-	-	-	-	-	-
600/55-26.5 165A8		Rear	Rear	-	-	-	-	-	-	3,6	5,2	4,2	6,1	4,8	7,0	6,0	8,7
710/45-26.5 163/168A8	Rear	Rear	Rear	-	-	-	-	-	-	3,4	4,9	4,0	5,8	4,6	6,7	6,0	8,7
14 - 15 tons load. Forwarder 8 w. Machine weight 15.000 - 17.500 kg without load																	
600/55-26.5 165A8	Front/Rear	Front/Rear	Front/Rear	3,1	4,4	3,6	5,2	4,1	6,0	3,6	5,2	4,2	6,1	4,8	7,0	6,0	8,7
710/45-26.5 163/168A8	Front/Rear	Front/Rear	Front/Rear	2,9	4,2	3,4	4,9	3,9	5,7	3,4	4,9	4,0	5,8	4,6	6,7	6,0	8,7
16 tons load. Forwarder 6 w. Machine weight 16.000 - 18.000 kg without load																	
600/65-34 157/163A8		Front		2,0	3,0	2,4	3,5	2,8	4,0	-	-	-	-	-	-	-	-
710/55-34 161/166A8		Front		1,9	2,7	2,2	3,2	2,5	3,7	-	-	-	-	-	-	-	-
710/45-26.5 173A8		Rear		-	-	-	-	-	-	3,8	5,5	4,5	6,5	5,2	7,5	6,0	8,7
750/50-26.5 174A8			Rear	-	-	-	-	-	-	3,6	5,2	4,2	6,1	4,8	7,0	6,0	8,7
750/55-26.5 182A8		Rear		-	-	-	-	-	-	3,6	5,2	4,2	6,1	4,8	7,0	6,0	8,7
710/50-30.5 173A8			Rear	-	-	-	-	-	-	3,7	5,4	4,4	6,4	5,1	7,3	6,0	8,7
750/45-30.5 173A8			Rear	-	-	-	-	-	-	3,6	5,2	4,2	6,1	4,8	7,0	6,0	8,7
16 tons load. Forwarder 8 w. Machine weight 18.000 - 20.000 kg without load																	
710/45-26.5 173A8	Front/Rear			3,1	4,4	3,6	5,2	4,1	6,0	3,8	5,5	4,5	6,5	5,2	7,5	6,0	8,7
750/50-26.5 174A8			Front/Rear	3,0	4,3	3,5	5,1	4,0	5,8	3,6	5,2	4,2	6,1	4,8	7,0	6,0	8,7
750/50-26.5 182A8	Front/Rear			3,0	4,3	3,5	5,1	4,0	5,8	3,6	5,2	4,2	6,1	4,8	7,0	6,0	8,7
710/50-30.5 173A8			Front/Rear	3,0	4,3	3,5	5,1	4,0	5,8	3,7	5,4	4,4	6,4	5,1	7,3	6,0	8,7
750/45-30.5 173A8			Front/Rear	2,8	4,1	3,3	4,8	3,8	5,5	3,6	5,2	4,2	6,1	4,8	7,0	6,0	8,7
18 - 20 tons load. Forwarder 6 w. Machine weight 17.000 - 21.000 kg without load																	
710/55-34 161/166A8		Front		2,4	3,5	2,8	4,1	3,2	4,7	-	-	-	-	-	-	-	-
750/65-34 169A8				2,4	3,5	2,8	4,1	3,2	4,7	-	-	-	-	-	-	-	-
750/50-26.5 174A8			Rear	-	-	-	-	-	-	3,8	5,5	4,5	6,5	5,2	7,5	6,0	8,7
750/55-26.5 182A8		Rear		-	-	-	-	-	-	3,8	5,5	4,5	6,5	5,2	7,5	6,0	8,7
710/50-30.5 173A8			Rear	-	-	-	-	-	-	3,9	5,7	4,6	6,7	5,3	7,7	6,0	8,7
750/45-30.5 173A7			Rear	-	-	-	-	-	-	3,0	4,3	3,5	5,1	4,0	5,8	6,0	8,7
780/50-28.5 182A8		Rear		-	-	-	-	-	-	3,8	5,5	4,5	6,5	5,2	7,5	6,0	8,7
18 - 20 tons load. Forwarder 8 w. Machine weight 20.000 - 24.000 kg without load																	
750/50-26.5 174A8			Front/Rear	3,0	4,3	3,5	5,1	4,0	5,8	3,8	5,5	4,5	6,5	5,2	7,5	6,0	8,7
750/50-26.5 182A8	Front/Rear			3,0	4,3	3,5	5,1	4,0	5,8	3,8	5,5	4,5	6,5	5,2	7,5	6,0	8,7
710/50-30.5 173A8			Front/Rear	3,2	4,7	3,8	5,5	4,4	6,3	3,9	5,7	4,6	6,7	5,3	7,7	6,0	8,7
750/45-30.5 173A8			Front/Rear	3,0	4,3	3,5	5,1	4,0	5,8	3,8	5,5	4,5	6,5	5,2	7,5	6,0	8,7
780/50-28.5 82A8	Front/Rear			3,8	5,5	4,5	6,5	5,2	7,5	3,8	5,5	4,5	6,5	5,2	7,5	6,0	8,7

Machine	Pattern			Inflation pressure													
																	
	Tire size / LI	T480	T440	T428	Front			Rear			With track usage						
Min					Normal	Max	Min	Normal	Max	bar	p.s.i	bar	p.s.i				
bar														p.s.i	bar	p.s.i	
Smaller 4 w for thinning. Machine weight 8.500 - 10.000 kg																	
600/55-26.5 165A8	Front/Rear	Front/Rear	Front/Rear	2,6	37	3,0	44	3,5	50	2,6	37	3,0	44	3,5	50	-	-
710/45-26.5 163A8	Front/Rear	Front/Rear	Front/Rear	2,4	35	2,8	41	3,2	47	2,4	35	2,8	41	3,2	47	-	-
Smaller 6 w for thinning. Machine weight 15.500 - 16.500 kg																	
600/65-34 157A8		Rear		-	-	-	-	-	-	1,9	27	2,2	32	2,5	37	-	-
710/55-34 161A8		Rear		-	-	-	-	-	-	1,7	25	2,0	29	2,3	33	-	-
600/50-22.5 149A8	Front		Front	2,2	32	2,6	38	3,0	43	-	-	-	-	-	-	5,0	73
650/45-22.5 150A8		Front		2,1	31	2,5	36	2,9	42	-	-	-	-	-	-	5,0	73
710/40-22.5 151A8	Front		Front	2,0	30	2,4	35	2,8	40	-	-	-	-	-	-	5,0	73
600/55-26.5 165A8	Front	Front	Front	2,0	30	2,4	35	2,8	40	-	-	-	-	-	-	5,0	73
710/45-26.5 163A8	Front	Front	Front	1,7	25	2,0	29	2,3	33	-	-	-	-	-	-	5,0	73
Smaller 8 w for thinning. Machine weight 14.500-16.000 kg																	
600/50-22.5 149A8	Front/Rear		Front/Rear	2,2	32	2,6	38	3,0	43	1,9	27	2,2	32	2,5	37	5,0	73
650/45-22.5 150A8		Front/Rear		2,1	31	2,5	36	2,9	42	1,8	26	2,1	30	2,4	35	5,0	73
710/40-22.5 151A8	Front/Rear		Front/Rear	2,0	30	2,4	35	2,8	40	1,7	25	2,0	29	2,3	33	5,0	73
Medium size 4 w. Machine weight 14.500 - 16.500 kg																	
600/65-34 157/163A8		Front/Rear		2,2	32	2,6	38	3,0	43	2,2	32	2,6	38	3,0	43	-	-
710/55-34 161/166A8		Front/Rear		2,0	30	2,4	35	2,8	40	2,0	30	2,4	35	2,8	40	-	-
Medium size 6 w. Machine weight 17.000 - 19.500 kg																	
600/65-34 157/163A8		Rear		-	-	-	-	-	-	2,2	32	2,6	38	3,0	43	-	-
710/55-34 161/166A8		Rear		-	-	-	-	-	-	2,0	30	2,4	35	2,8	40	-	-
600/55-26.5 165A8	Front	Front	Front	2,6	37	3,0	44	3,5	50	-	-	-	-	-	-	6,0	87
710/45-26.5 163A8	Front	Front	Front	2,4	35	2,8	41	3,2	47	-	-	-	-	-	-	6,0	87
Medium size 8 w. Machine weight 18.000 - 19.500 kg																	
600/55-26.5 165A8	Front/Rear	Front/Rear	Front/Rear	2,6	37	3,0	44	3,5	50	2,2	32	2,6	38	3,0	43	6,0	87
710/45-26.5 163A8	Front/Rear	Front/Rear	Front/Rear	2,4	35	2,8	41	3,2	47	2,0	30	2,4	35	2,8	40	6,0	87
Large 6 w for final felling. Machine weight 21.000 - 25.500 kg																	
710/55-34 161/166A8		Rear		-	-	-	-	-	-	2,1	31	2,5	36	2,9	42	-	-
750/65-34 169A8				-	-	-	-	-	-	2,0	30	2,4	35	2,8	40	-	-
600/55-26.5 165A8	Front	Front	Front	3,6	52	4,2	61	4,8	70	-	-	-	-	-	-	6,0	87
710/45-26.5 168A8	Front	Front	Front	3,4	49	4,0	58	4,6	67	-	-	-	-	-	-	6,0	87
710/50-30.5 173A8			Front	2,7	39	3,2	46	3,7	53	-	-	-	-	-	-	6,0	87
750/50-26.5 174A8			Front	2,6	37	3,0	44	3,5	50	-	-	-	-	-	-	6,0	87
750/55-26.5 182A8	Front			2,6	37	3,0	44	3,5	50	-	-	-	-	-	-	6,0	87
750/45-30.5 173A8			Front	2,7	39	3,2	46	3,7	53	-	-	-	-	-	-	6,0	87
Large 8 w for final felling. Machine weight 21.000 - 25.500 kg																	
710/50-30.5 173A8			Front/Rear	3,0	43	3,5	51	4,0	58	3,0	43	3,5	51	4,0	58	6,0	87
750/50-26.5 174A8			Front/Rear	2,9	42	3,4	49	3,9	57	2,9	42	3,4	49	3,9	57	6,0	87
750/50-26.5 182A8	Front/Rear			2,9	42	3,4	49	3,9	57	2,9	42	3,4	49	3,9	57	6,0	87
750/45-30.5 173A8			Front/Rear	2,9	42	3,4	49	3,9	57	2,9	42	3,4	49	3,9	57	6,0	87







Trelleborg Wheel Systems reserves the right to modify the data contained in this issue without notice.

For the disposal of tires out of service, Trelleborg Wheel Systems recommends adherence to specific country laws.



Subject to technical amendments, printing errors and mistakes in text or illustrations. 09.23



Discover our website

Follow us



Yokohama TWS S.p.A.  
Via Nazionale Tiburtina, 143 - 00019 Villa Adriana - Tivoli (RM), Italy  
Phone: +39 0774 3841 – info.tws@yokohama-tws.com  
www.trelleborg-tires.com